

A13.5 Watercourse Crossings

1 Introduction

- 1.1 This appendix provides additional information on the watercourse crossings and engineering activities within watercourses that are to be constructed or modified as part of the proposed scheme. Table 1 (Section 2) provides information on the watercourse crossing proposals, outfalls and watercourse realignments as well as justification for each engineering solution. To supplement this information, photographs are provided within the table.
- 1.2 General arrangement drawings are provided for watercourse crossings in Section 3.
- 1.3 This appendix should be read in conjunction with the following sections of the ES:
- Chapter 13 (Road Drainage and the Water Environment (RDWE)) – Impacts - Construction (Section 13.6), Impacts – Operation (Section 13.7) and mitigation measures (Section 13.8).
 - Appendix A13.4 – this summarises residual impacts during both the construction and operational phases, after the implementation of mitigation for each watercourse.
 - Appendix A13.1 Baseline Conditions (RDWE).
 - Figure 13.1 Features of the Water Environment.



2 Watercourse Crossing Information

- 2.1 Table 1 provides information on the watercourse crossings and activities within watercourses which are affected by the proposed scheme. A high level justification for the engineering activity is provided. The location of the watercourse crossings is shown in Figure 13.1 of the ES (Chapter 13: Road Drainage and the Water Environment). Mitigation information is provided in Section 13.8 of the RDWE and further detail on mitigation would be provided during the Controlled Activities Regulations (CAR) licence application process.

Table 1: Watercourse Crossings and Engineering Activities Additional Information



Surface water Feature	Photographs	Engineering Drawings	Construction Detail	Justification for Engineering Solution
<p>SWF 02: Scretan Burn</p>	 <p>Looking upstream at the A96 culvert and wing wall</p> <p>Gabion basket bank reinforcement upstream of the A96 culvert</p>	<p>B2103500-ST-C02-DR-001 Rev 0</p>	<p>One channel realignment (approximately 250m in length)</p> <p>Construction of three outfalls (A, B and C)</p> <p>Construction of one new culvert (C02 approximately 66m in length)</p> <p>Removal of existing culvert (redundant)</p>	<p>The crossing of the Scretan Burn by the proposed scheme results in a new structure. A 3.6m by 2.7m dimension box culvert has been selected as the optimum solution, conveying the design flow, allowing mammal passage and in-channel connectivity, whilst being acceptable in operational and construction terms.</p> <p>To assist the construction of the new culvert, an offline solution is preferred.</p> <p>The proposed burn realignment avoids a lengthy skew structure under the mainline and junction. The proposed culvert location minimises the length of the culvert and maximises the length of open channel.</p> <p>Drainage networks A and B are located at a dual carriageway low point and split either side of the culverted watercourse to avoid the need to cross the structure. Each outfall has been designed to suit the optimal Pond/Basin location providing the shortest link to the nearest watercourse.</p> <p>Drainage network C conveys runoff from Smithton Junction to the lowest part of the alignment. The outfall is sited adjacent to the watercourse to reduce pipe length.</p>



Surface water Feature	Photographs	Engineering Drawings	Construction Detail	Justification for Engineering Solution
<p>SWF 03: Cairnlaw Burn</p>	 <p>The Barn Church Road culvert</p>  <p>Straight upstream section</p>	<p>B2103500-ST-C03-DR-001 Rev 0</p> <p>B2103500-ST-C04-DR-001 Rev 0</p>	<p>Two realignments: (approximately 83m and 490m in length)</p> <p>Construction of two outfalls (D and E)</p> <p>Construction of two culverts (C03, approximately 40m in length, and C04, approximately 60m in length)</p> <p>Removal of existing culvert (replaced by C03)</p>	<p>The crossing of the Cairnlaw Burn by the proposed scheme results in two new structures. A 4.2m by 3.0m and a 4.2m by 3.6m dimension box culverts have been selected as the optimum solution, conveying the design flow, allowing mammal passage and in-channel connectivity, whilst being acceptable in operational and construction terms.</p> <p>The proposed burn realignment avoids a lengthy skew structure under the mainline and junction. The proposed culvert location minimises the length of the culvert and maximises the length of open channel.</p> <p>Drainage networks D and E are located at a dual carriageway low point and split either side of the culverted watercourse to avoid the need to cross the structure. Each outfall has been designed to suit the optimal Pond/Basin location providing the shortest link to the diverted watercourse.</p>

Surface water Feature	Photographs	Engineering Drawings	Construction Detail	Justification for Engineering Solution
SWF 05: Tributary of Cairnlaw Burn (2)	 <p>SWF 05 downstream of Glenbeg</p>		One realignment (approximately 61m in length)	A short realignment is proposed to tie into realigned SW03 – Cairnlaw Burn.
SWF 06: Kenneth's Black Well	 <p>Twin pipe culvert observed in upstream reach</p>	<p>B2103500-ST-C05-DR-001 Rev 001</p> <p>B2103500-ST-C26-DR-001 Rev 001</p> <p>B2103500-ST-C27-DR-001 Rev 001</p> <p>B2103500-ST-C29-DR-001 Rev 001</p> <p>B2103500-ST-C30-DR-001 Rev 001</p>	<p>Two realignments (approximately 217m and 320m in length)</p> <p>Construction of one outfall: (F)</p> <p>Construction of five new culverts (C05, approximately 54m in length; C26, approximately 88m in length; C27, approximately 10m in length; C29, approximately 6m in length, C30, approximately 24m in length)</p>	<p>The crossing of Kenneth's Black Well by the proposed scheme results in a new structure. A 3.0m by 2.1m dimension box culvert has been selected as the optimum solution under the dual carriageway, conveying the design flow, allowing mammal passage and in-channel connectivity, whilst being acceptable in operational and construction terms.</p> <p>To avoid impacting on a number of residential properties at Milton of Culloden South, a flood overflow channel is proposed to provide additional capacity under the design event. The flood channel would have one culvert at 1.2m by 1.5m and three further culverts at 2.1m by 1.5m. The alignment of the flood channel is heavily constrained by properties, utilities and the proposed dual carriageway.</p> <p>Drainage network F is located on a longitudinally graded section of the dual carriageway and acts as an interim outfall. This has the effect of reducing the land required to construct the downstream drainage network E. The outfall has been</p>

Surface water Feature	Photographs	Engineering Drawings	Construction Detail	Justification for Engineering Solution
	 <p data-bbox="325 852 808 885">Twin pipe culvert and bank reinforcement in upstream reach</p>			<p data-bbox="1409 462 1969 511">designed to tie into the diverted watercourse over the shortest distance possible.</p>

Surface water Feature	Photographs	Engineering Drawings	Construction Detail	Justification for Engineering Solution
<p>SWF 07: Drain at Allanfearn</p>	 <p data-bbox="325 971 812 1008">Straight uniform planform downstream of the culvert</p>	<p>B2103500-ST-C06-DR-001 Rev 001</p>	<p>Two realignments (approximately 205m and 200m in length)</p> <p>Construction of one new culvert (C06, approximately 90m in length)</p>	<p>The crossing of the drain at Allanfearn by the proposed scheme results in a new structure. A 1.8m by 1.8m dimension box culvert has been selected as the optimum solution, conveying the design flow, allowing mammal passage and in-channel connectivity, whilst being acceptable in operational and construction terms.</p> <p>To avoid a culverted connection under the dual carriageway, part of the drain would be realigned to the north.</p> <p>An open channel would replace existing piped section of the drain to its connection into an existing culvert under the existing A96 near Allanfearn Cottage.</p>

Surface water Feature	Photographs	Engineering Drawings	Construction Detail	Justification for Engineering Solution
SWF 08: Fiddler's Burn	 <p>Choked channel upstream of the A96 culvert</p>	B2103500-ST-C07-DR-001 Rev 001	<p>One realignment (approximately 190m in length)</p> <p>Construction of one outfall (G)</p> <p>Construction of one new culvert (C07, approximately 103m in length)</p>	<p>The crossing of Fiddler's Burn by the proposed scheme results in a new structure. A 2.4m by 2.4m dimension box culvert has been selected as the optimum solution, conveying the design flow, allowing mammal passage and in-channel connectivity, whilst being acceptable in operational and construction terms.</p> <p>Fiddler's Burn would be realigned to avoid the proposed drainage pond and basin, and the Balloch Junction slip roads.</p> <p>Drainage network G conveys runoff from the Balloch Junction to the lowest point of the junction. The outfall location is determined by existing watercourse levels</p>
SWF 09: Tributary of Rough Burn	 <p>Straightened uniform upstream reach</p>	B2103500-ST-C08-DR-001 Rev 001	<p>Construction of two outfalls (H and I)</p> <p>Construction of one new culvert (C08, approximately 48m in length)</p>	<p>The crossing of the Tributary of Rough Burn by the proposed scheme results in a new structure. A 2.7m by 2.7m dimension box culvert has been selected as the optimum solution, conveying the design flow, allowing mammal passage and in-channel connectivity, whilst being acceptable in operational and construction terms.</p> <p>Drainage networks H and I are located at a dual carriageway low point and split either side of the culverted watercourse to avoid the need to cross the structure. Each outfall has been designed to suit the optimal basin location providing the shortest link to the nearest watercourse.</p>

Surface water Feature	Photographs	Engineering Drawings	Construction Detail	Justification for Engineering Solution
	 <p data-bbox="325 857 535 878">Culvert under the A96</p>			
<p>SWF 12: Rough Burn</p>	 <p data-bbox="325 1268 739 1289">The artificial bed under the A96 road bridge</p>	<p>B2103500-ST-C09-DR-001 Rev 001</p>	<p>One realignment (approximately 231m in length)</p> <p>Construction of one new culvert (C09, approximately 74m in length)</p>	<p>Multiple constraints in this area have resulted in a dual carriageway alignment for the proposed scheme, which requires the watercourse to be realigned.</p> <p>The crossing of the Rough Burn by the proposed scheme results in a new structure. A 3.0m by 2.1m dimension box culvert has been selected as the optimum solution, conveying the design flow, allowing mammal passage and in-channel connectivity, whilst being acceptable in operational and construction terms.</p> <p>The proposed burn realignment is required to help during construction and to match the existing length and gradient of the existing burn alignment.</p>

Surface water Feature	Photographs	Engineering Drawings	Construction Detail	Justification for Engineering Solution
	 <p data-bbox="325 846 716 865">Cobbles upstream of the A96 road bridge</p>			



Surface water Feature	Photographs	Engineering Drawings	Construction Detail	Justification for Engineering Solution
<p>SWF 13: Tributary of 'Unnamed Burn – Castle Stuart to source (Tornagrain)' (1)</p>	 <p>Choked channel downstream of the A96 culvert</p>	<p>B2103500-ST-C10-DR-001 Rev 001</p>	<p>Construction of two outfalls (J and K)</p> <p>Construction of one new culvert (C10, approximately 60m in length)</p>	<p>Drainage network J is located on a longitudinally graded section of dual carriageway and acts as an interim outfall prior to the Kerrowaid overbridge. This removes the need to take pipes across the structure. The outfall has been located to provide an adequate gradient from pond to watercourse.</p> <p>Drainage network K is located at a low point and conveys runoff from the remainder of the dual carriageway to the north-east of Kerrowaid overbridge. The outfall has been located to avoid the NMU track and is at the closest point between pond and watercourse.</p> <p>The crossing of the SWF13 by the proposed scheme results in a new structure. A 1.8m by 1.8m dimension box culvert has been selected as the optimum solution, conveying the design flow, allowing mammal passage and in-channel connectivity, whilst being acceptable in operational and construction terms. A localised increase in flood risk affecting a woodland area has been deemed preferable to the engineering interventions required in the same area to maintain flood levels as per the baseline.</p>



Surface water Feature	Photographs	Engineering Drawings	Construction Detail	Justification for Engineering Solution
<p>SWF 14: Unnamed Burn – Castle Stuart to source (Tornagrain)</p>	 <p>Riparian buffer observed upstream from the confluence with SWF 15</p>	<p>B2103500-ST-C11-DR-001 Rev 001</p>	<p>Construction of one new culvert (C11, approximately 42m in length)</p>	<p>The crossing of the Unnamed Burn – Castle Stuart to source (Tornagrain) by the proposed scheme results in a new structure. A 2.7m by 2.1m dimension box culvert has been selected as the optimum solution, conveying the design flow, allowing mammal passage and in-channel connectivity, whilst being acceptable in operational and construction terms.</p> <p>The proposed culvert location avoids the need to realign the existing burn.</p>



Surface water Feature	Photographs	Engineering Drawings	Construction Detail	Justification for Engineering Solution
<p>SWF 15: Tributary of 'Unnamed Burn – Castle Stuart to source (Tornagrain)' (2)</p>	 <p data-bbox="325 976 812 1011">Straight uniform upstream reach with resectioned banks and overdeepened channel</p>	<p>B2103500-ST-C12-DR-001 Rev 001</p>	<p>Construction of one new culvert (C12, approximately 64m in length)</p>	<p>The crossing of the Tributary of 'Unnamed Burn – Castle Stuart to source (Tornagrain)' (2) by the proposed scheme results in a new structure. A 1.8m by 1.8m dimension box culvert has been selected as the optimum solution, conveying the design flow, allowing mammal passage and in-channel connectivity, whilst being acceptable in operational and construction terms.</p> <p>The proposed culvert location avoids the need to realign the existing burn.</p>



Surface water Feature	Photographs	Engineering Drawings	Construction Detail	Justification for Engineering Solution
<p>SWF 16: Tributary of Ardersier Burn</p>	 <p data-bbox="325 850 739 873">Straight channel downstream of the culvert</p>	<p data-bbox="837 488 1016 532">B2103500-ST-C13-DR-001 Rev 001</p>	<p data-bbox="1066 488 1356 532">One realignment (approximately 260m in length)</p> <p data-bbox="1066 565 1373 609">Construction of three outfalls (L, V and M)</p> <p data-bbox="1066 641 1373 732">Construction of two new culverts (C13, approximately 58m in length and C14, approximately 40m in length)</p> <p data-bbox="1066 764 1310 808">Removal of existing culvert (redundant)</p> <p data-bbox="1066 841 1283 862">Extension of one culvert</p>	<p data-bbox="1409 488 1969 558">Multiple constraints in this area have resulted in a dual carriageway alignment for the proposed scheme which requires the watercourse to be realigned.</p> <p data-bbox="1409 591 1969 725">The crossing of the Tributary of Ardersier Burn by the proposed scheme results in a new structure (C13). A 3.3m by 2.4m dimension box culvert has been selected as the optimum solution, conveying the design flow, allowing mammal passage and in-channel connectivity, whilst being acceptable in operational and construction terms.</p> <p data-bbox="1409 758 1969 938">The existing Tributary of Ardersier Burn would be realigned around the south roundabout of the proposed Mid-Coul junction. The eastern side of the burn would flow through part of the flood storage reservoir. The western side of the burn would pass around the south roundabout to avoid a lengthy culvert and to increase the length of the open channel. This culvert (C14) is subject to detailed design as part of the flood reservoir design and is not shown within this appendix.</p> <p data-bbox="1409 971 1969 1083">Drainage networks L and V are located at a dual carriageway low point and split either side of the culverted watercourse to avoid the need to cross the structure. Each outfall has been designed to suit the optimal pond/basin location providing the shortest link to the nearest watercourse.</p> <p data-bbox="1409 1278 1969 1369">Drainage network M is located on a longitudinally graded section and acts as an interim outfall. This has the effect of reducing the land required to construct the downstream drainage network L and V. The outfall location follows an</p>

Surface water Feature	Photographs	Engineering Drawings	Construction Detail	Justification for Engineering Solution
				extended conveyance route in order to tie-in to the existing watercourse at a suitable level.
SWF 17: Drains at Culblair	 <p>Straight channel along the railway line</p>	<p>B2103500-ST-C22-DR-001 Rev 001</p> <p>B2103500-ST-C31-DR-001 Rev 001</p>	<p>Construction of two new culverts (C22, approximately 66m in length, and C31, approximately 12m in length).</p>	<p>The proposed culverts would replace the existing piped watercourse. The realignment would result in a new open channel and two 2.4m by 2.4m box culverts.</p>



Surface water Feature	Photographs	Engineering Drawings	Construction Detail	Justification for Engineering Solution
	 <p data-bbox="325 846 642 867">Straight channel on the farm side</p>			
<p>SWF 18: Indirect tributary drains of Ardersier Burn</p>	 <p data-bbox="325 1291 621 1312">A96 culvert (looking upstream)</p>	<p>B2103500-ST-C15-DR-001 Rev 001</p> <p>B2103500-ST-C16-DR-001 Rev 001</p>	<p>One realignment (approximately 310m in length)</p> <p>Construction of one outfall (N)</p> <p>Construction of two new culverts (C15, approximately 56m in length and C16, approximately 58m in length)</p>	<p>Multiple constraints in this area have resulted in a dual carriageway alignment for the proposed scheme, which requires the watercourse to be realigned.</p> <p>The crossing of the indirect tributary drains of Ardersier Burn by the proposed scheme results in two new structures. A 2.1m by 1.8m dimension box culvert has been selected as the optimum solution, conveying the design flow, allowing mammal passage and in-channel connectivity, whilst being acceptable in operational and construction terms.</p> <p>The realignment of the drain is proposed to avoid a lengthy skew culvert.</p> <p>Drainage network N is located on a longitudinally graded section of dual carriageway and acts as an interim outfall prior to the next downstream low-point. This has the effect of reducing the land required to construct the downstream drainage network M. The outfall location is directly adjacent to</p>

Surface water Feature	Photographs	Engineering Drawings	Construction Detail	Justification for Engineering Solution
	 <p>Outfall and bank reinforcement downstream of the A96 culvert</p>			<p>the SUDS basin, which keeps it perpendicular to the diverted watercourse.</p>
<p>SWF19 Balnagowan Burn</p>	 <p>Choked upstream section</p>	<p>B2103500-ST-C17-DR-001 Rev 001</p> <p>B2103500-ST-C23-DR-001 Rev 001</p>	<p>Construction of extension to SWF (approximately 150m in length)</p> <p>Construction of three outfalls (O, P and Q)</p> <p>Construction of two new culverts (C17, approximately 42m in length and C23, approximately 14m in length)</p>	<p>The crossing of the Balnagowan Burn by the proposed scheme results in two new structures. A 2.4m by 2.4m and a 2.4m by 1.8m dimension box culvert have been selected as the optimum solution, conveying the design flow, allowing mammal passage and in-channel connectivity, whilst being acceptable in operational and construction terms.</p> <p>The proposed culvert locations avoid the need to realign the existing Balnagowan Burn.</p> <p>Drainage network O is located at a carriageway low point The outfall has been located to enable the runoff to enter a culvert under the Aberdeen to Inverness Railway Line before following the line of existing field drainage to an outfall point which has been confirmed by the landowner.</p> <p>Drainage networks P and Q are located at a dual carriageway low point and split either side of the culverted watercourse to</p>

Surface water Feature	Photographs	Engineering Drawings	Construction Detail	Justification for Engineering Solution
	 <p data-bbox="325 898 800 917">Scour observed on the left bank in upstream reach</p>			<p data-bbox="1409 464 1967 529">avoid the need to cross the structure. Each outfall has been designed to suit the optimal pond location providing the shortest link to the nearest watercourse.</p>
SWF22 Alton Burn	 <p data-bbox="325 1304 800 1323">Straight channel downstream of the culvert</p>	<p data-bbox="835 950 1016 995">B2103500-ST-C18-DR-001 Rev 001</p> <p data-bbox="835 1024 1016 1070">B2103500-ST-C25-DR-001 Rev 001</p>	<p data-bbox="1066 950 1339 969">Construction of one outfall (R)</p> <p data-bbox="1066 989 1373 1057">Construction of two culverts (C18, approximately 127m in length and C25, approximately 10m in length)</p>	<p data-bbox="1409 950 1967 1040">Drainage network R is located at a low point of the dual carriageway and the adjacent link road. The outfall location takes account of existing watercourse levels to provide a suitable tie-in gradient.</p> <p data-bbox="1409 1073 1967 1209">The crossing of SWF22 by the proposed scheme results in two new structures. Two 2.7m by 2.7m dimension box culverts have been selected as the optimum solution, conveying the design flow, allowing mammal passage and in-channel connectivity, whilst being acceptable in operational and construction terms.</p> <p data-bbox="1409 1242 1967 1287">The proposed culvert locations avoid the need to realign the existing Alton Burn.</p>

Surface water Feature	Photographs	Engineering Drawings	Construction Detail	Justification for Engineering Solution
SWF23 River Nairn	 <p>Wide channel with side bars downstream of B9090 Bridge</p>  <p>Side channel observed downstream of the B9090 Bridge</p>	B2103500-ST-PS14-DR-001 Rev 001	<p>Construction of clear span bridge over SWF</p> <p>Construction of one outfall (S)</p>	<p>The crossing of the River Nairn by the proposed scheme requires a new structure. A 142.5m clear span bridge has been selected as the optimum solution, conveying the design flow, with only very localised increases in flood water levels, and not affecting any sensitive receptors.</p> <p>Drainage network S is located at a low point of the dual carriageway and avoids any adverse interaction with the new structure. The outfall location is designed to provide a short link to the River Nairn.</p>

Surface water Feature	Photographs	Engineering Drawings	Construction Detail	Justification for Engineering Solution
SWF24 Tributary of the River Nairn	 <p data-bbox="325 1070 604 1092">Straightened upstream reach</p>	B2103500-ST-C19-DR-001 Rev 001	<p>Construction of two outfalls (T and U)</p> <p>Construction of one new culvert (C19, approximately 52m in length)</p>	<p>Drainage networks T and U are located at a dual carriageway low point and split either side of the culverted watercourse to avoid the need to cross the structure. Each outfall has been designed to suit the optimal pond/basin location providing the shortest link to the nearest watercourse.</p> <p>The crossing of the SWF24 by the proposed scheme results in a new structure. A 1.8m by 1.5m dimension box culvert has been selected as the optimum solution, conveying the design flow, allowing mammal passage and in-channel connectivity, whilst being acceptable in operational and construction terms.</p> <p>The proposed culvert location avoids the need to realign the existing Tributary of the River Nairn.</p>

Surface water Feature	Photographs	Engineering Drawings	Construction Detail	Justification for Engineering Solution
<p>SWF26 Auldearn Burn</p>	 <p>Straightened downstream reach</p>  <p>Culvert under the A96 at Auchnacloch</p>	<p>B2103500-ST-C20-DR-001 Rev 001</p>	<p>One realignment (approximately 157m in length)</p> <p>Construction of three outfalls (W, X and Y)</p> <p>Construction of one new culvert (C20, approximately 48m in length)</p>	<p>The crossing of the SWF09 by the proposed scheme results in a new structure. A 5.0m by 2.0m dimension box culvert has been selected as the optimum solution, conveying the design flow, allowing mammal passage and in-channel connectivity, whilst being acceptable in operational and construction terms.</p> <p>The culvert is on the current alignment as the existing burn. The realignment to the north of the dual carriageway avoids a tight curve in the burn near the tie into the existing burn.</p> <p>Drainage network W conveys runoff from the Nairn East Junction to the lowest part of the dual carriageway. The outfall location is sited at the nearest watercourse which requires an extended connection, along the edge of the adjacent field boundary.</p> <p>Drainage networks X and Y are located at a dual carriageway low point and split either side of the culverted watercourse to avoid the need to cross the structure. Each outfall has been designed to suit the optimal pond/basin location providing the shortest link to the nearest watercourse.</p>

Surface water Feature	Photographs	Engineering Drawings	Construction Detail	Justification for Engineering Solution
	 <p data-bbox="325 938 653 959">Culvert under the A96 at Auldearn</p>			
SWF35 Tributary of Auldearn Burn – Brightmony Tributary	No photo		Construction of one outfall (Z)	Drainage network Z is located at a dual carriageway low point. The outfall location is sited at the nearest watercourse, which requires an extended connection, along the edge of the adjacent field boundary.

3 General Arrangement Drawings

3.1 General arrangement drawing of watercourse crossings for the following surface water features are provided, as listed below:

- SWF02 Scretan Burn - B2103500-ST-C02-DR-001 Rev 001
- SWF03 Cairnlaw Burn –
 - B2103500-ST-C03-DR-001 Rev 001
 - B2103500-ST-C04-DR-001 Rev 001
- SWF06 Kenneth's Black Well –
 - B2103500-ST-C05-DR-001 Rev 001
 - B2103500-ST-C26-DR-001 Rev 001
 - B2103500-ST-C27-DR-001 Rev 001
 - B2103500-ST-C29-DR-001 Rev 001
 - B2103500-ST-C30-DR-001 Rev 001
- SWF07 Drains at Allanfearne - B2103500-ST-C06-DR-001 Rev 001
- SWF08 Fiddler's Burn - B2103500-ST-C07-DR-001 Rev 001
- SWF09 Tributary of Rough Burn - B2103500-ST-C08-DR-001 Rev 001
- SWF12 Rough Burn - B2103500-ST-C09-DR-001 Rev 001
- SWF13 Tributary of 'Unnamed Burn – Castle Stuart to source (Tornagrain)' (1) - B2103500-ST-C10-DR-001 Rev 001
- SWF14 Unnamed Burn – Castle Stuart to source (Tornagrain)- B2103500-ST-C11-DR-001 Rev 001
- SWF15 Tributary of 'Unnamed Burn – Castle Stuart to source (Tornagrain)' (2) - B2103500-ST-C12-DR-001 Rev 001
- SWF16 Tributary of Ardersier Burn - B2103500-ST-C13-DR-001 Rev 001
- SWF17 Drains at Culblair
 - B2103500-ST-C22-DR-001 Rev 001
 - B2103500-ST-C31-DR-001 Rev 001
- SWF18 Indirect tributary drains of Ardersier Burn –
 - B2103500-ST-C15-DR-001 Rev 001
 - B2103500-ST-C16-DR-001 Rev 001
- SWF19 Balnagowan Burn –
 - B2103500-ST-C17-DR-001 Rev 001
 - B2103500-ST-C23-DR-001 Rev 001
- SWF22 Alton Burn –
 - B2103500-ST-C18-DR-001 Rev 001
 - B2103500-ST-C25-DR-001 Rev 001
- SWF23 River Nairn – B2103500-ST-PS14-DR-001 Rev 001
- SWF24 Tributary of the River Nairn - B2103500-ST-C19-DR-001 Rev 001
- SWF26 Auldearn Burn - B2103500-ST-C20-DR-001 Rev 001

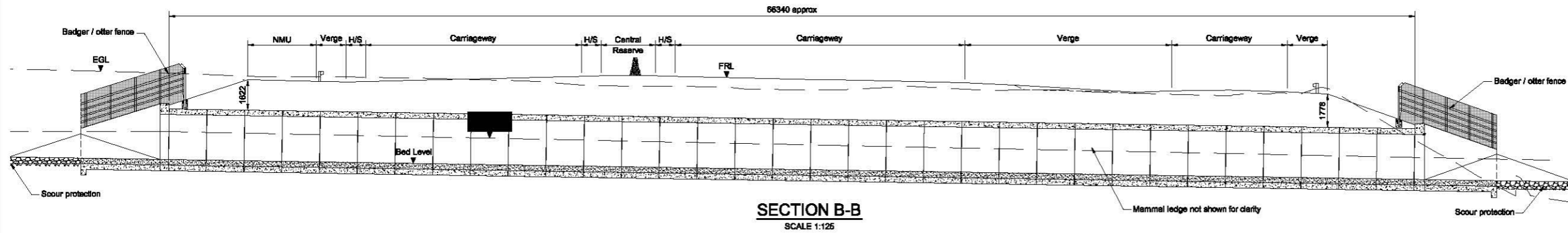

- NOTES:**
1. All dimensions in millimetres unless noted otherwise.
 2. All chainages are in metres unless otherwise noted.
 3. Do not scale from this drawing.
 4. All exposed arises to have 25x25 chamfer unless noted otherwise.
 5. Bedding requirements in accordance with BS EN 14844 or approved equivalent.
 6. All details shown on this drawing are indicative only and subject to change at detail design stage.

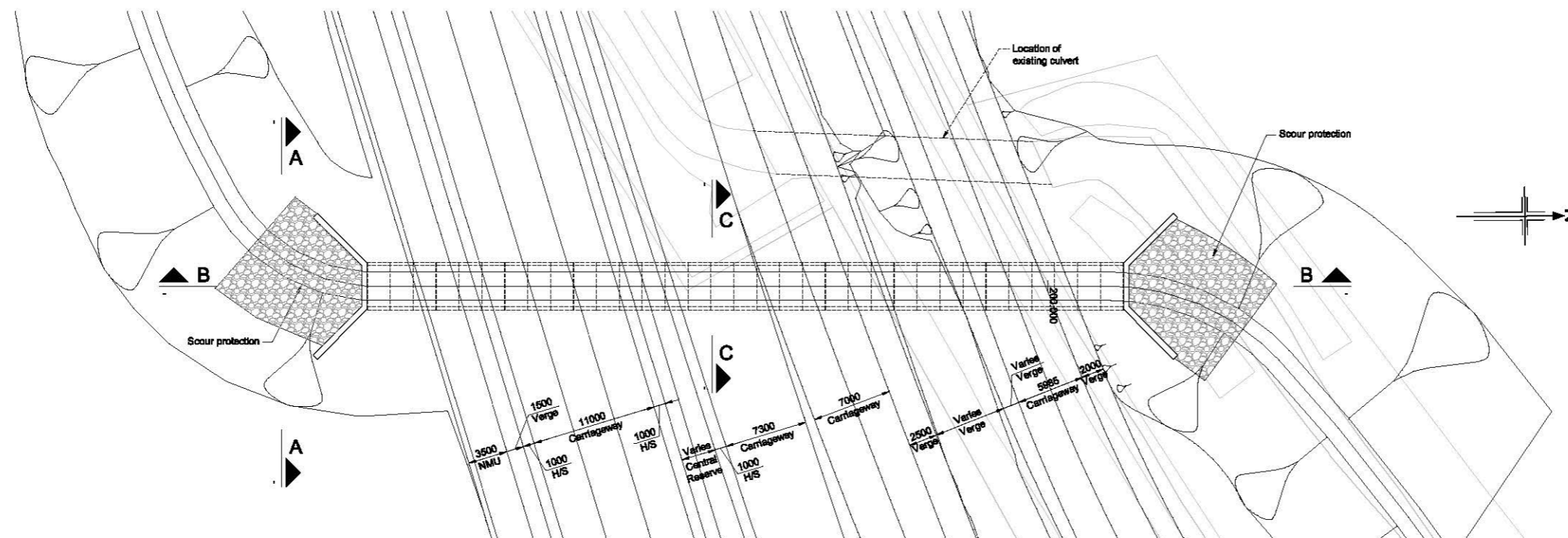
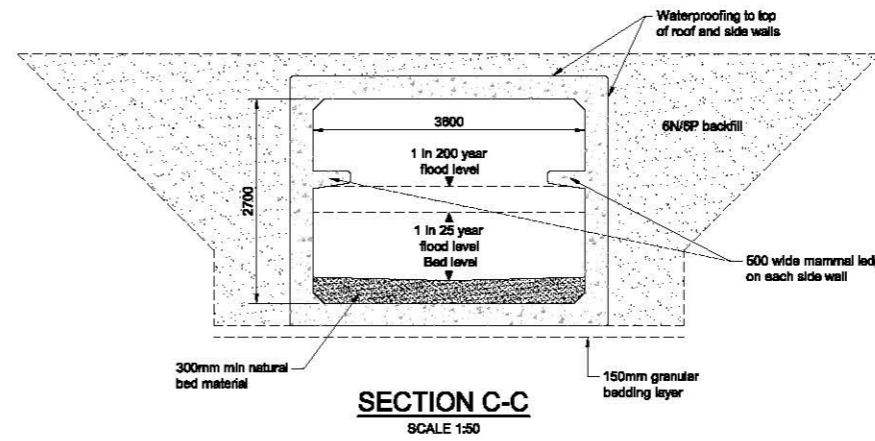
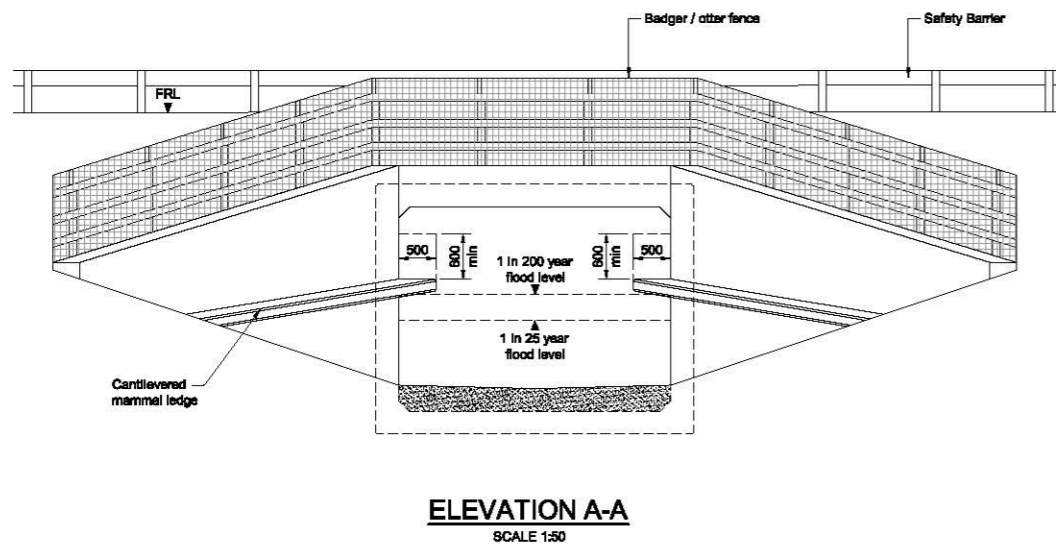

Rev	Rev. Date	Purpose of revision	Drawn	Checked	Rev'd	Apprv'd

JACOBS
 65 Rothwell Rd, Glasgow, G2 7JF
 Tel: +44(0)141 243 8200 Fax: +44(0)141 228 3108
 www.jacobs.com



**DMRB STAGE 3
 C02 SCRETAN BURN CULVERT
 GENERAL ARRANGEMENT**

Drawing title		
FOR INFORMATION		
Scale	AS SHOWN @ A1	DO NOT SCALE
Jacobs No.	B2103500	
BIM no.		
Drawing number	B2103500/ST/C02/DR/001	Rev
		0

This drawing is not to be used in whole or part other than for the intended purpose and project as defined on this drawing. Refer to the contract for full terms and conditions.

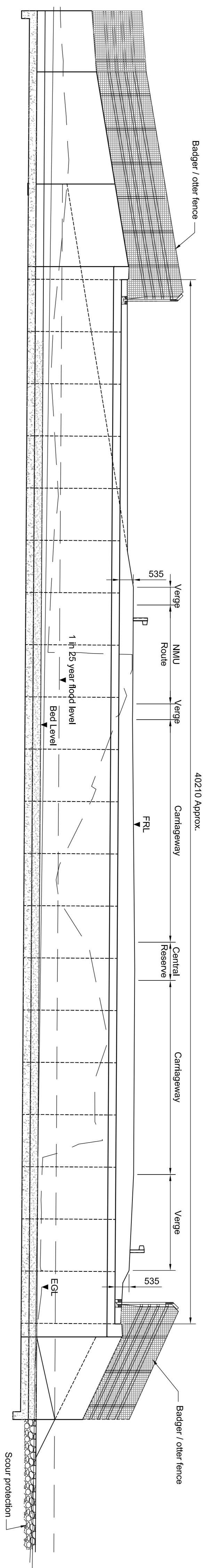

SECTION B-B
 SCALE 1:100

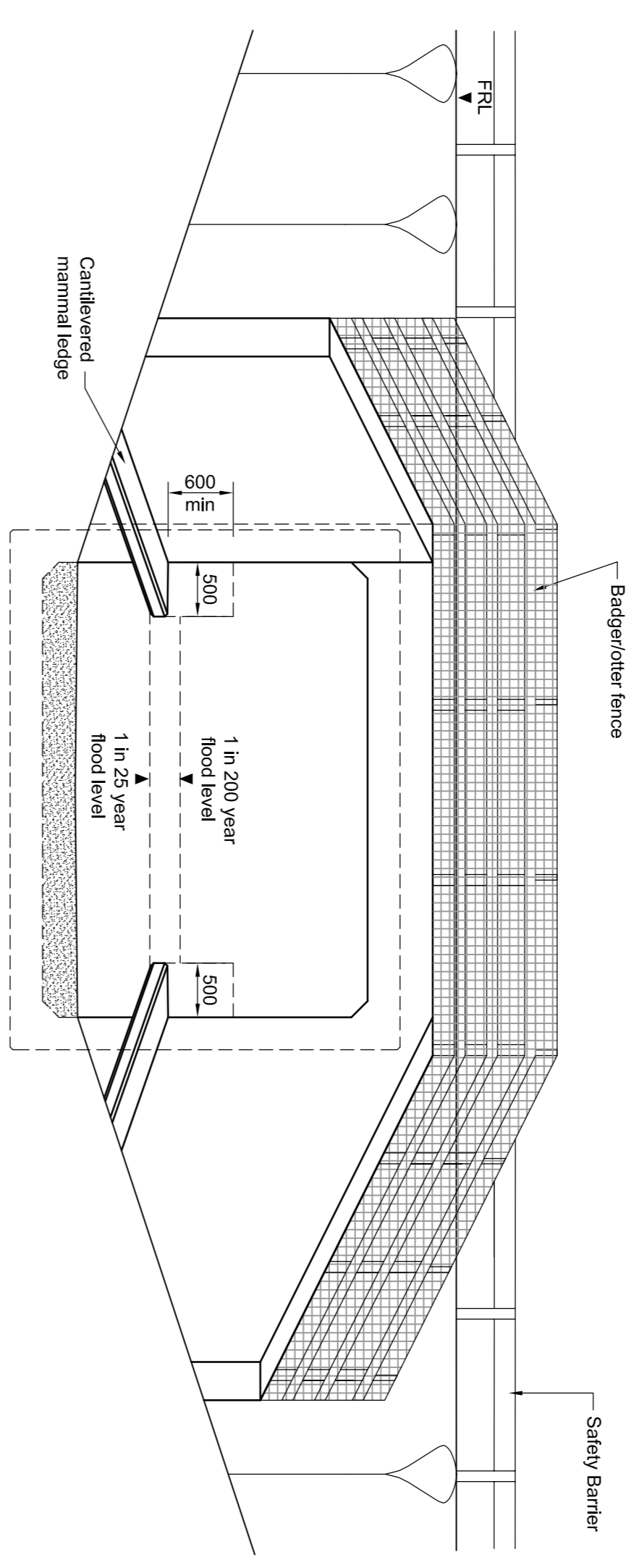

ELEVATION A-A
 SCALE 1:50

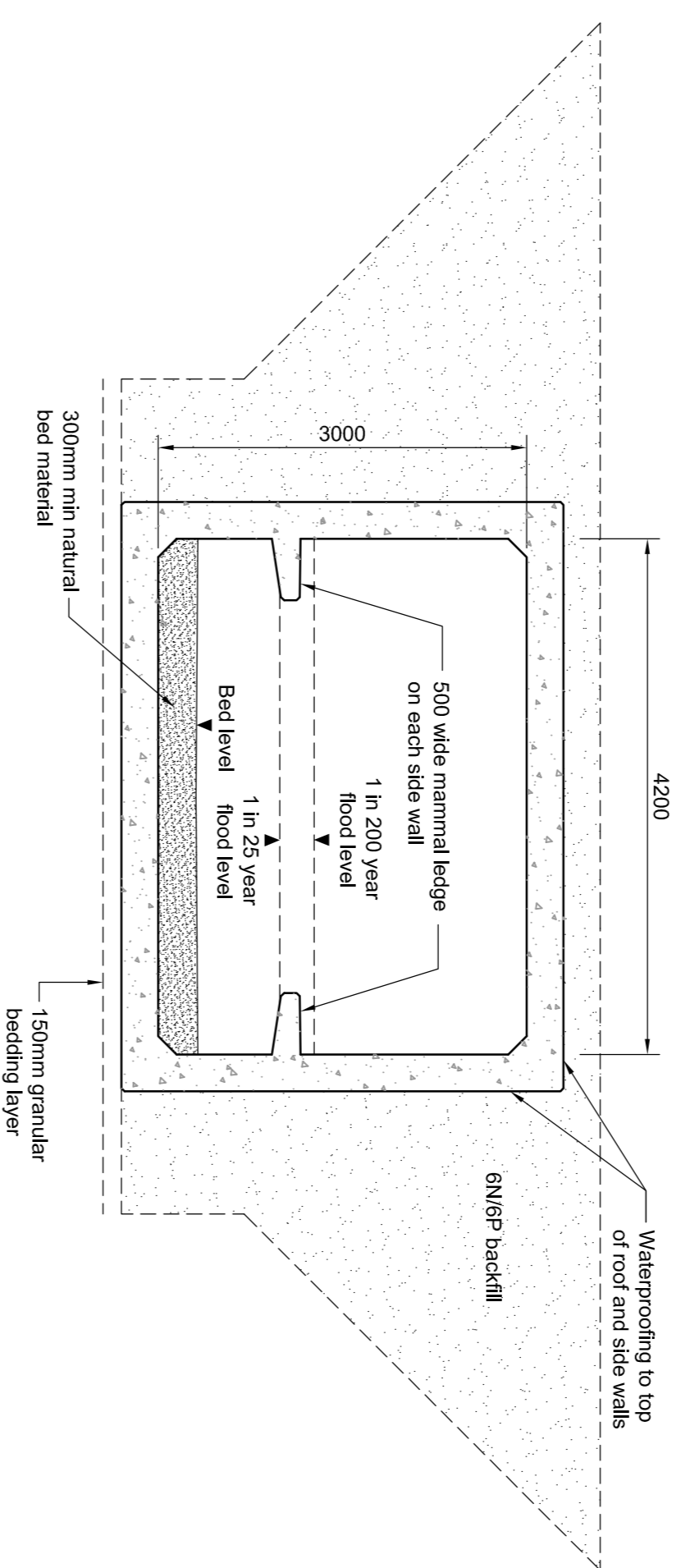

SECTION C-C
 SCALE 1:50

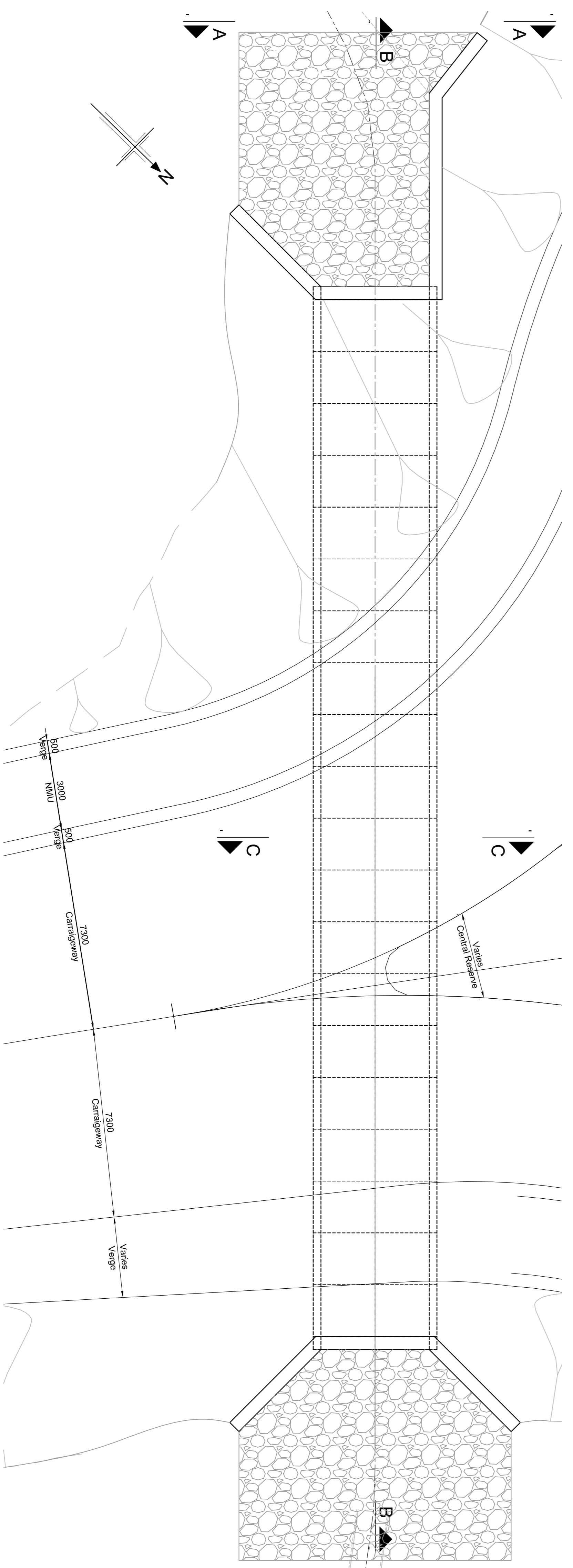

PLAN
 SCALE 1:100

- NOTES:**
1. All dimensions in millimetres unless noted otherwise.
 2. All changes are in metres unless otherwise noted.
 3. Do not scale from this drawing.
 4. All exposed areas to have 25x25 dmfmr unless noted otherwise.
 5. Bedding requirements in accordance with BS EN 14694 or approved equivalent.
 6. All details shown on this drawing are indicative only and subject to change at detail design stage.

Rev	Rev. Date	Purpose of revision	Drawn	Checked	Rev'd	Approved

Client: **JACOBS**
 35 Bonhill St, Glasgow, G2 7JX
 Tel: +44(0)11 737 9111 Fax: +44(0)11 737 9109
 www.jacobs.com

Project: **TRANSPORT SCOTLAND CÒR-DHAIL ALBA**

Drawing title: **DMRB STAGE 3 C3 CAIRNLAW BURN CULVERT NO 1 GENERAL ARRANGEMENT**

Drawing status: **FOR INFORMATION**

Scale: **AS SHOWN @ A1** DO NOT SCALE

Jacobs No: **B2103500**

Rev: **0**

Drawing number: **B2103500/ST/C03/DR/001**

This drawing is not to be used in whole or part other than for the intended purpose and project as defined on this drawing. Refer to the contract for full terms and conditions.

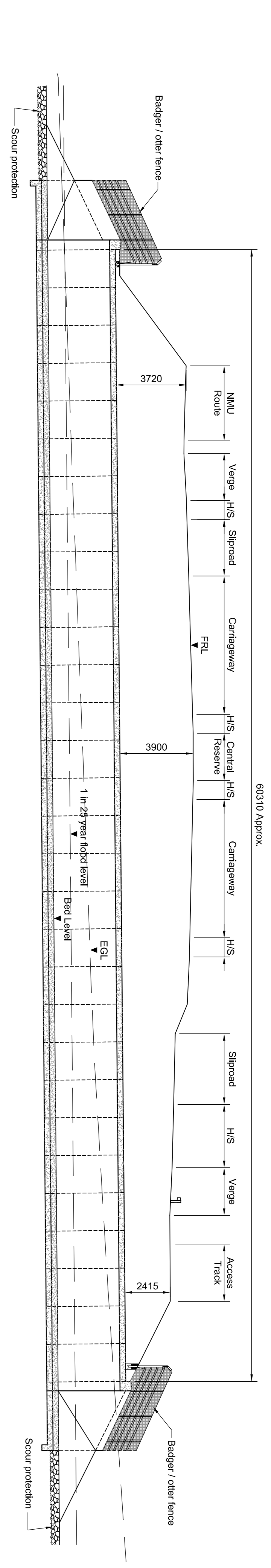

SECTION B-B
 SCALE 1:150

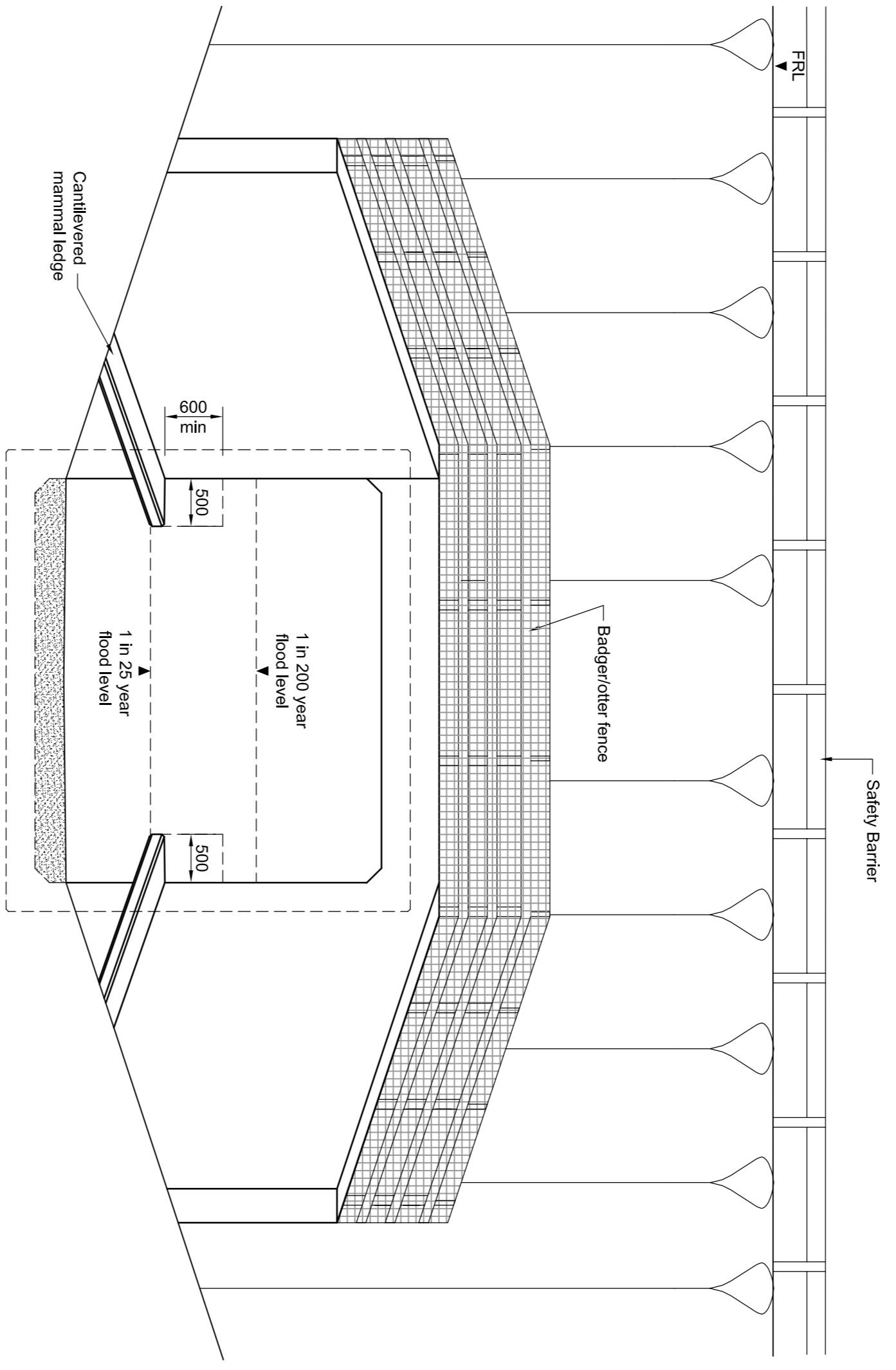

ELEVATION A-A
 SCALE 1:50

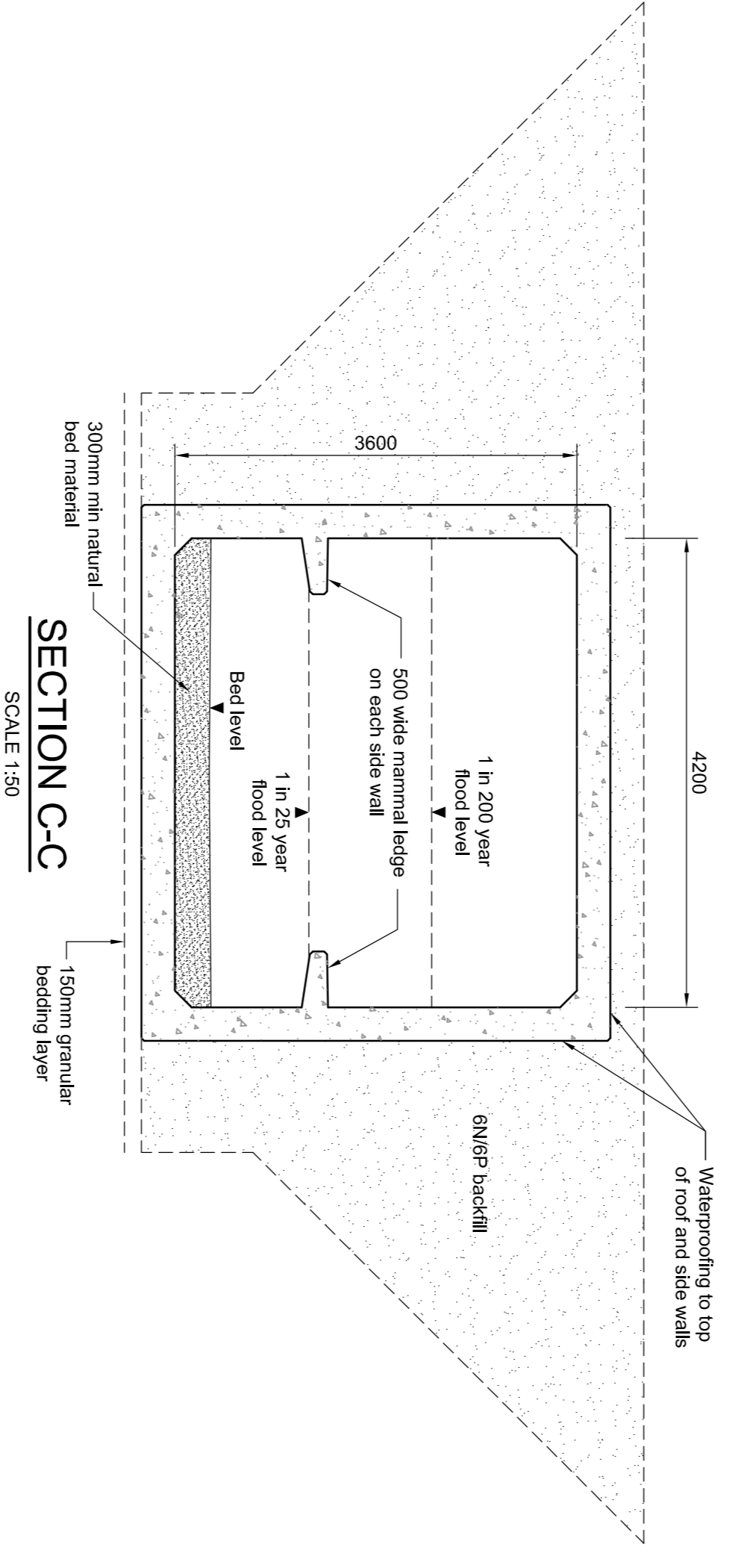

SECTION C-C
 SCALE 1:50

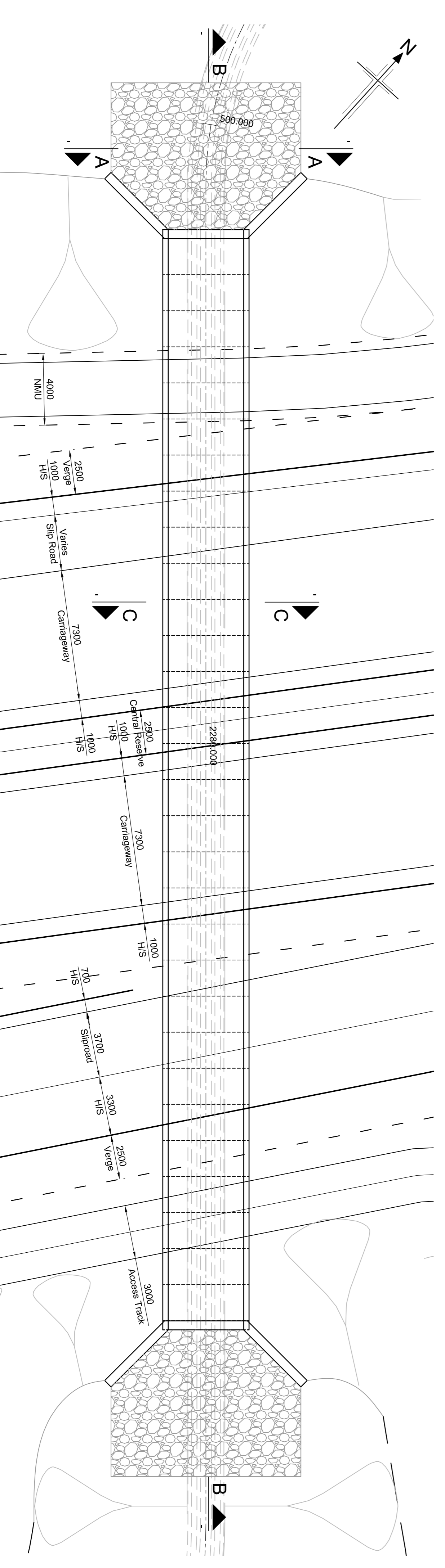

PLAN
 SCALE 1:150

- NOTES:**
1. All dimensions in millimetres unless noted otherwise.
 2. All changes are in metres unless otherwise noted.
 3. Do not scale from this drawing.
 4. All exposed assets to have 25x25 chamfer unless noted otherwise.
 5. Bedding requirements in accordance with BS EN 14644 or approved equivalent.
 6. All details shown on this drawing are indicative only and subject to change at detail design stage.

Rev	Rev. Date	Purpose of revision	Drawn	Checked	Rev'd	Approved

Client: **JACOBS**
 35 Bonhill St, Glasgow, G2 7JX
 Tel: +44(0)141 209 3109
 www.jacobs.com

Project: **TRANSPORT SCOTLAND CÒR-DHAIL ALBA**

Drawing title: **DMRB STAGE 3 C04 CAIRNLAW BURN CULVERT NO 2 GENERAL ARRANGEMENT**

Drawing status: **FOR INFORMATION**

Scale: **AS SHOWN @ A1** DO NOT SCALE

Jacobs No.: **B2103500**

Bill no.: **B2103500/ST/C04/DR/001**

Drawing number: **0**

This drawing is not to be used in whole or part other than for the intended purpose and project as defined on this drawing. Refer to the contract for full terms and conditions.

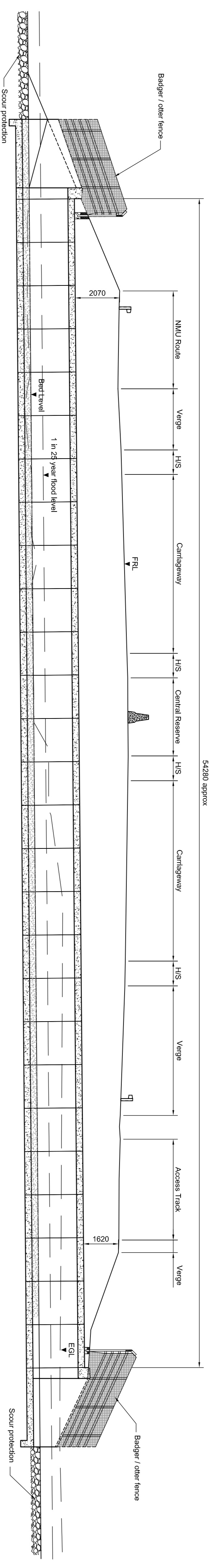

SECTION B-B
 SCALE 1:125

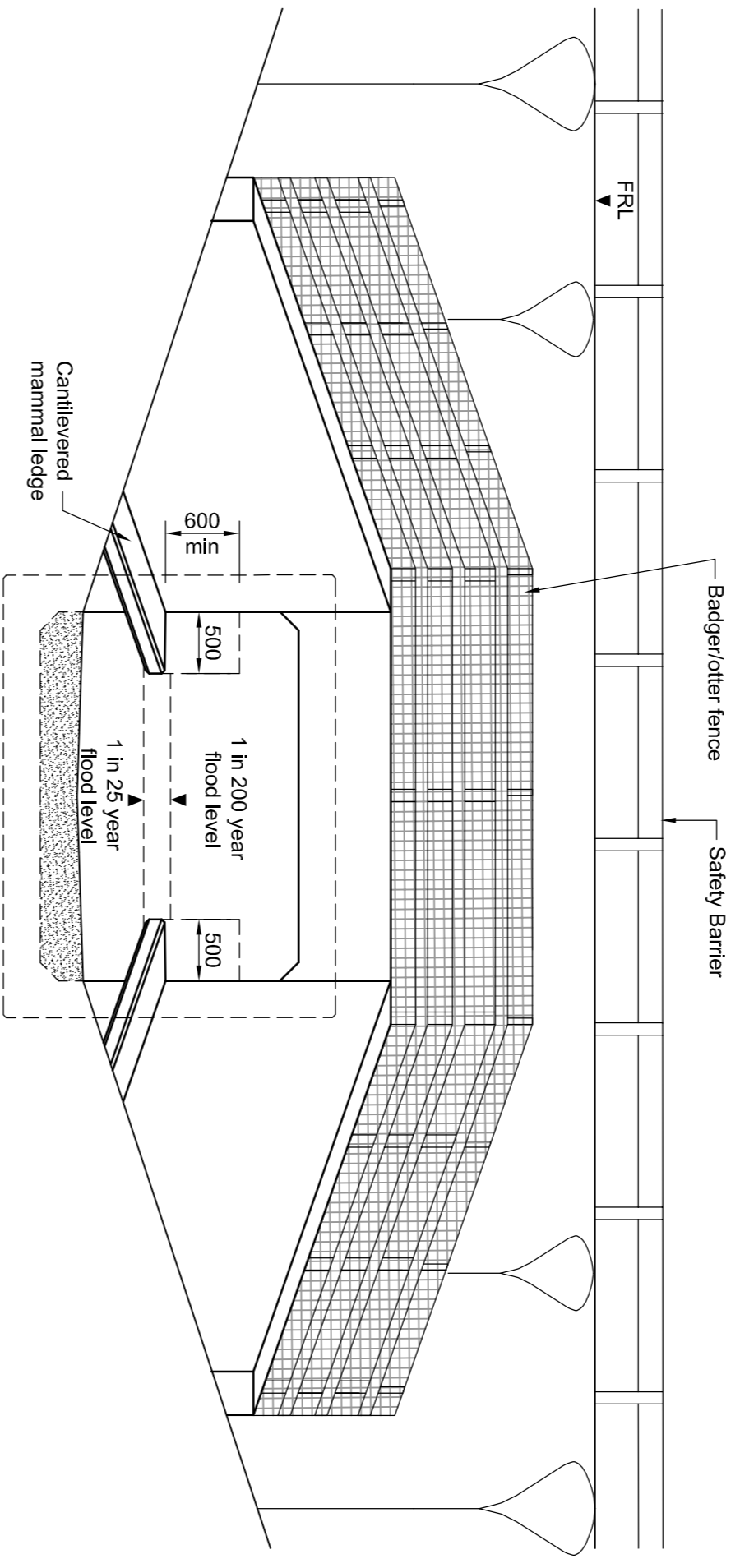

ELEVATION A-A
 SCALE 1:30

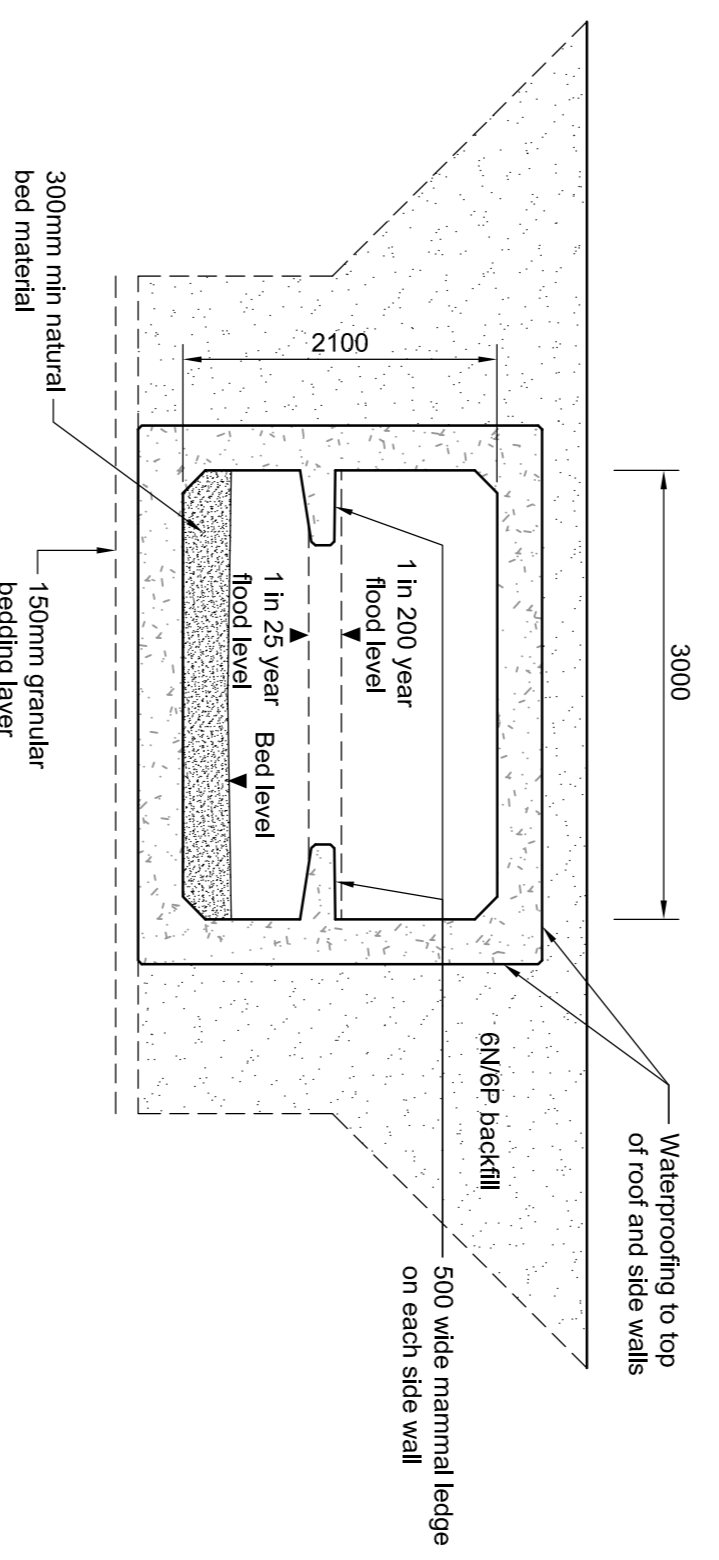

SECTION C-C
 SCALE 1:50

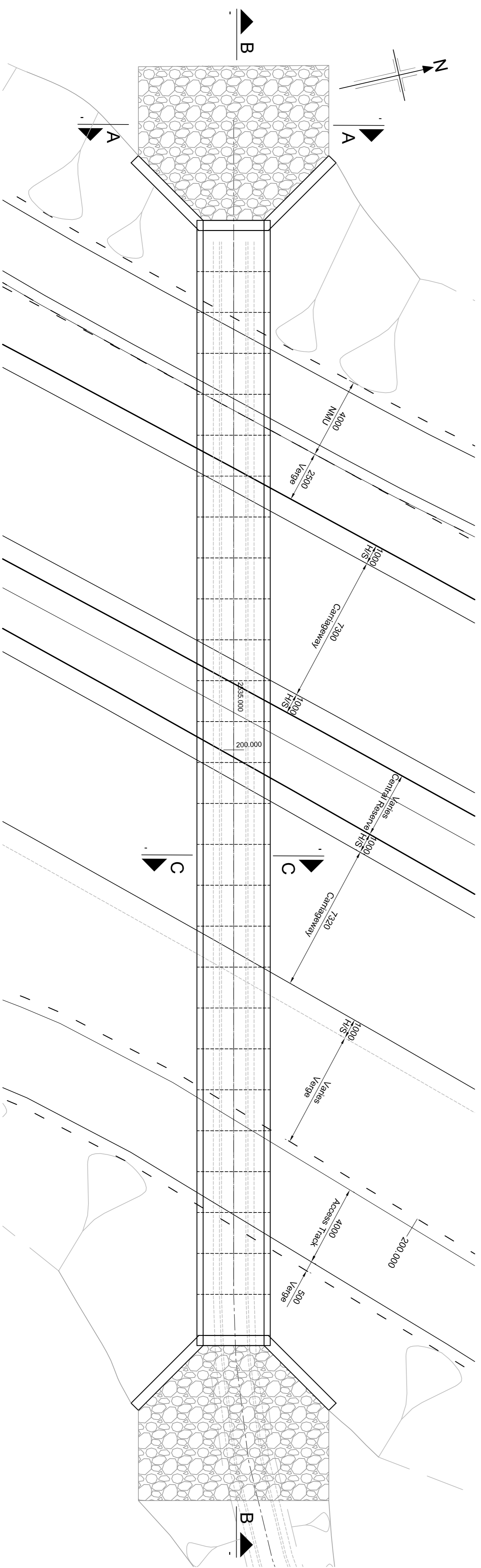

PLAN
 SCALE 1:125

- NOTES:**
1. All dimensions in millimetres unless noted otherwise.
 2. All changes are in metres unless otherwise noted.
 3. Do not scale from this drawing.
 4. All exposed assets to have 25x25 damper unless noted otherwise.
 5. Bedding requirements in accordance with BS EN 14644 or approved equivalent.
 6. All details shown on this drawing are indicative only and subject to change at detail design stage.

Rev	Rev. Date	Purpose of revision	Drawn	Checked	Rev'd	Approved

Client: **JACOBS**
 35 Bonhill St, Glasgow, G2 7HX
 Tel: +44(0)141 209 3100
 www.jacobs.com

Project: **TRANSPORT SCOTLAND CÒRHDHAL ALBA**

Drawing title: **DMRB STAGE 3 C05 KENNETH'S BLACK WELL CULVERT GENERAL ARRANGEMENT**

Drawing status: **FOR INFORMATION**

Scale: **AS SHOWN @ A1** DO NOT SCALE

Jacobs No.: **B2103500**

Bill no.: **B2103500/ST/C05/DR/001**

Drawing number: **0**

This drawing is not to be used in whole or part other than for the intended purpose and project as defined on this drawing. Refer to the contract for full terms and conditions.

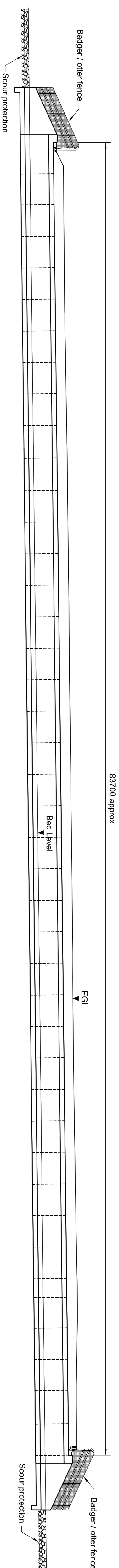

SECTION B-B
 SCALE 1:150

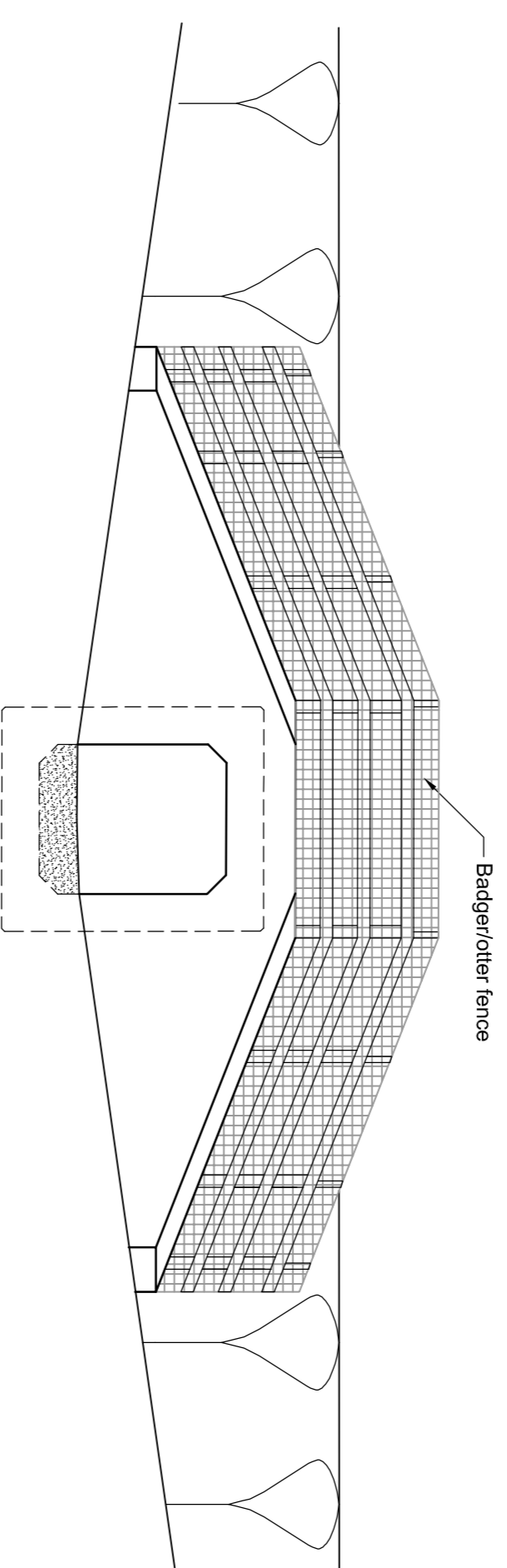

ELEVATION A-A
 SCALE 1:50

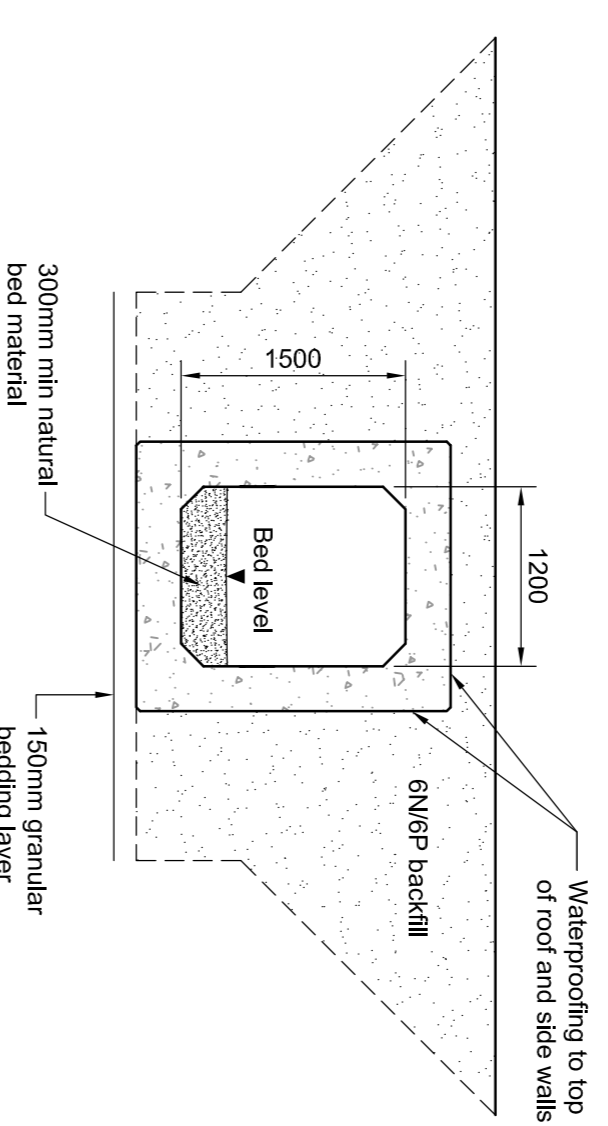

SECTION C-C
 SCALE 1:50

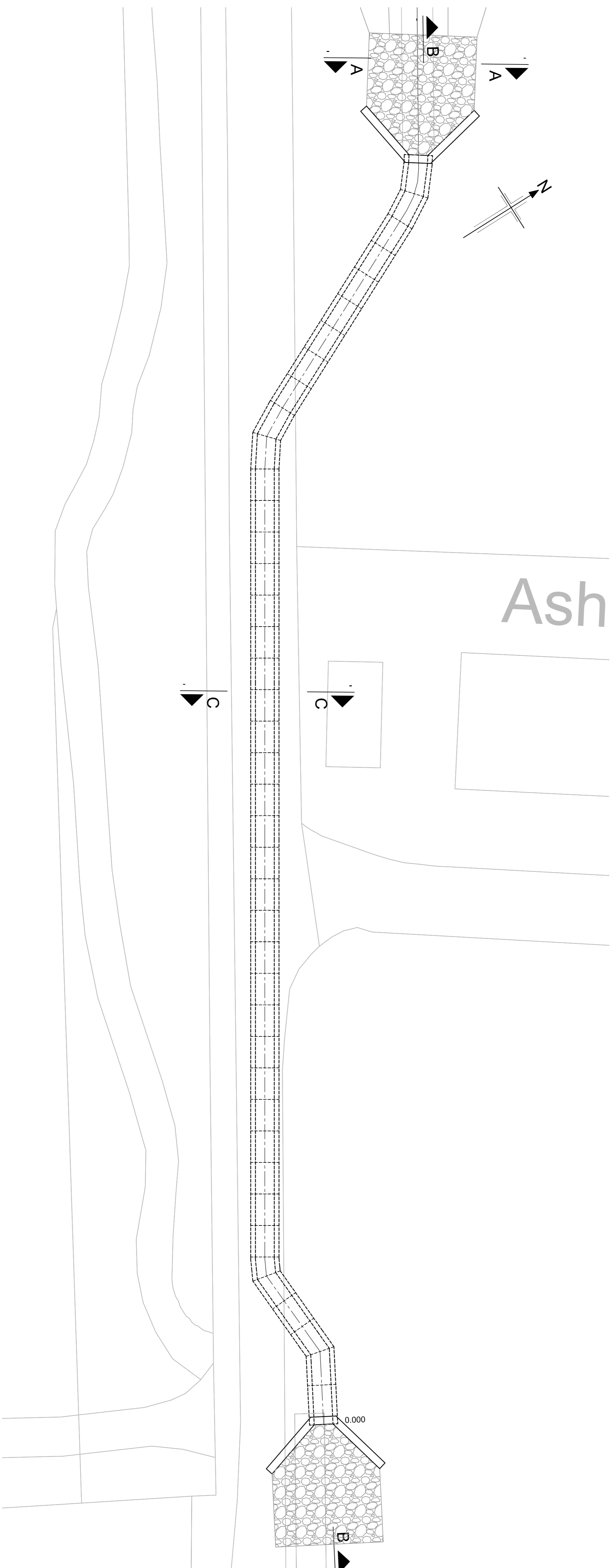

PLAN
 SCALE 1:150

- NOTES:**
1. All dimensions in millimetres unless noted otherwise.
 2. All changes are in metres unless otherwise noted.
 3. Do not scale from this drawing.
 4. All exposed asbes to have 25x25 damper unless noted otherwise.
 5. Bedding requirements in accordance with BS EN 14694 or approved equivalent.
 6. All details shown on this drawing are indicative only and subject to change at detail design stage.

Rev	Rev. Date	Purpose of revision	Drawn	Checked	Rev'd	Approved

JACOBS
 35 Bonhill St, Glasgow, G2 7HX
 Tel: +44(0)141 206 3100
 www.jacobs.com

Client



Project

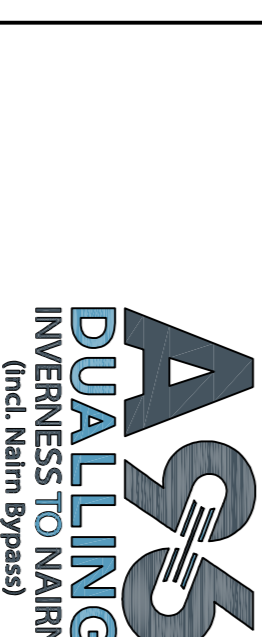

Drawing title

**DMRB STAGE 3
 C26 MILTON OF CULLODEN
 CULVERT No.1
 GENERAL ARRANGEMENT**

Drawing status

FOR INFORMATION

Scale	AS SHOWN @ A1	DO NOT SCALE
Jacobs No.	B2103500	
BIM/3d		
Drawing number	B2103500/ST/C26/DR/001	Rev
		0

This drawing is not to be used in whole or part other than for the intended purpose and project as defined on this drawing. Refer to the contract for full terms and conditions.

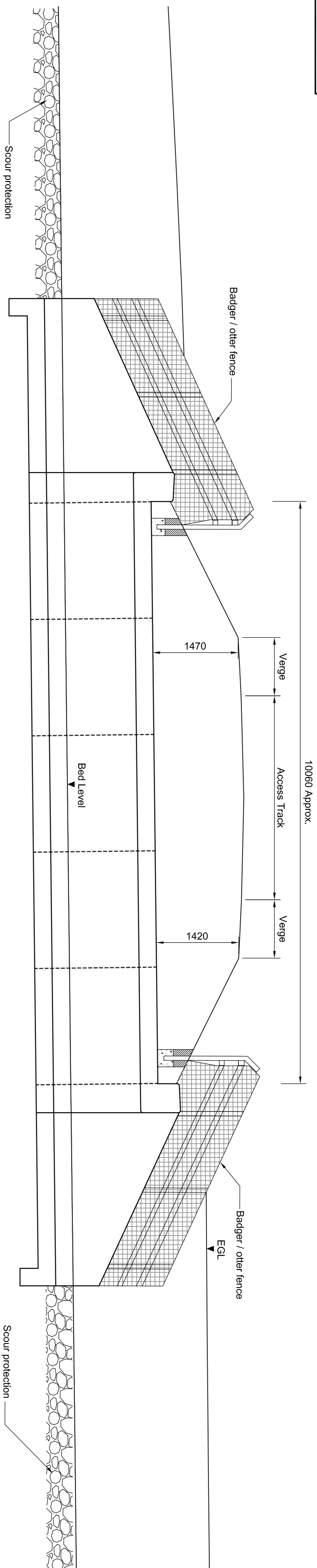

SECTION B-B
 SCALE 1:50

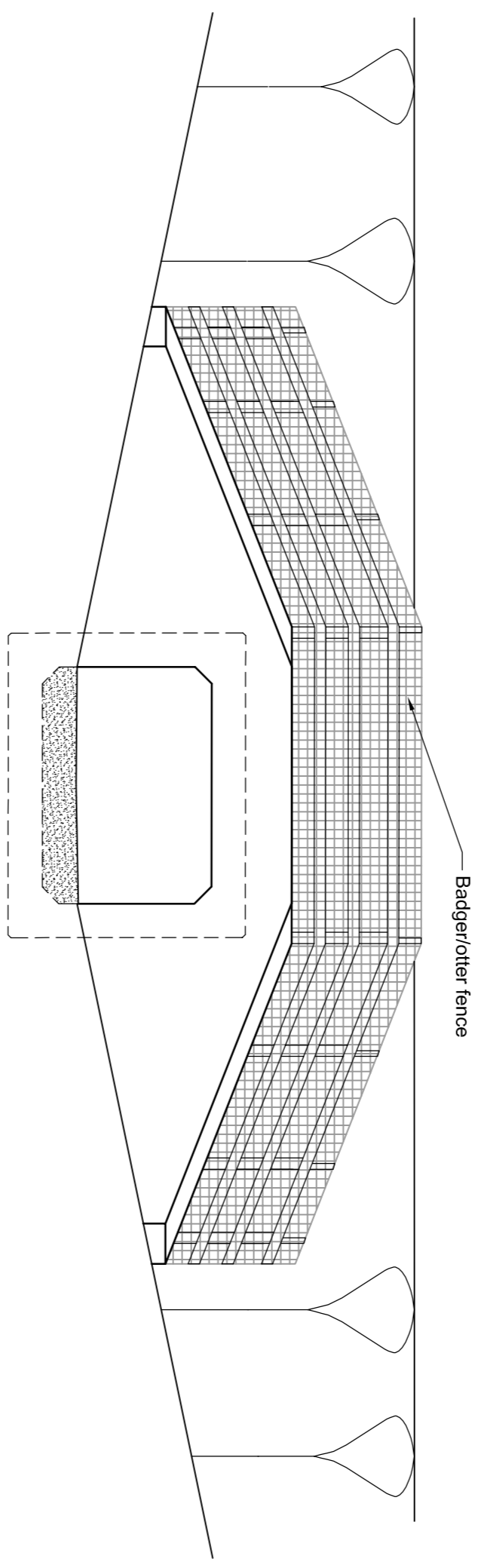

ELEVATION A-A
 SCALE 1:50

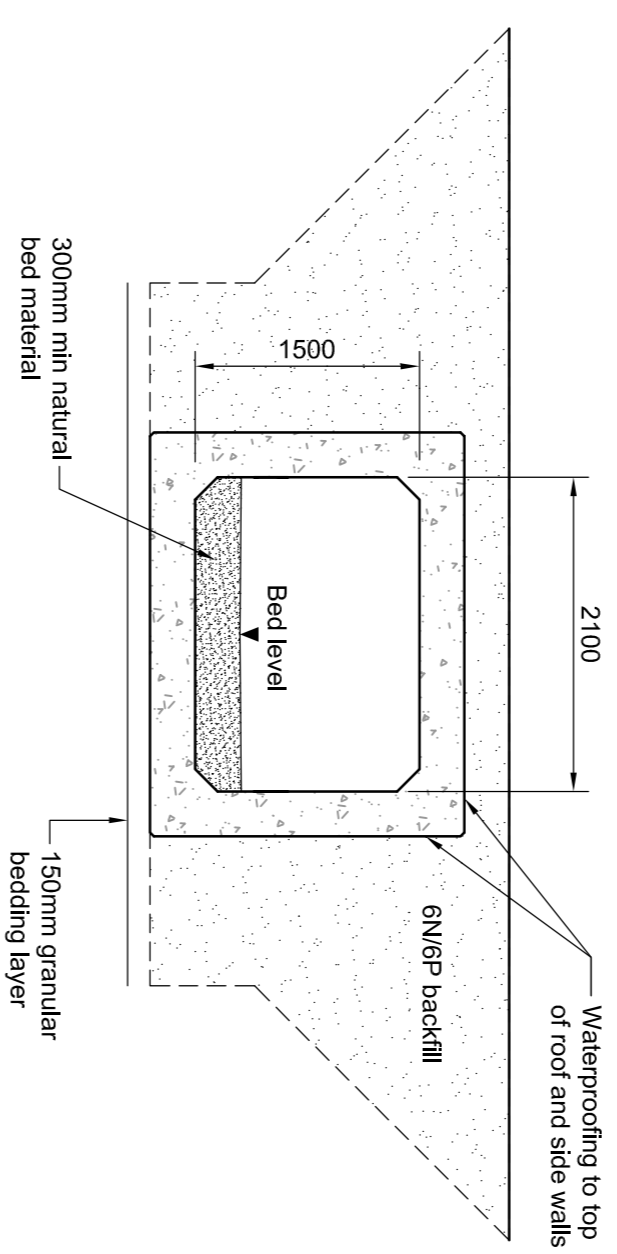

SECTION C-C
 SCALE 1:50

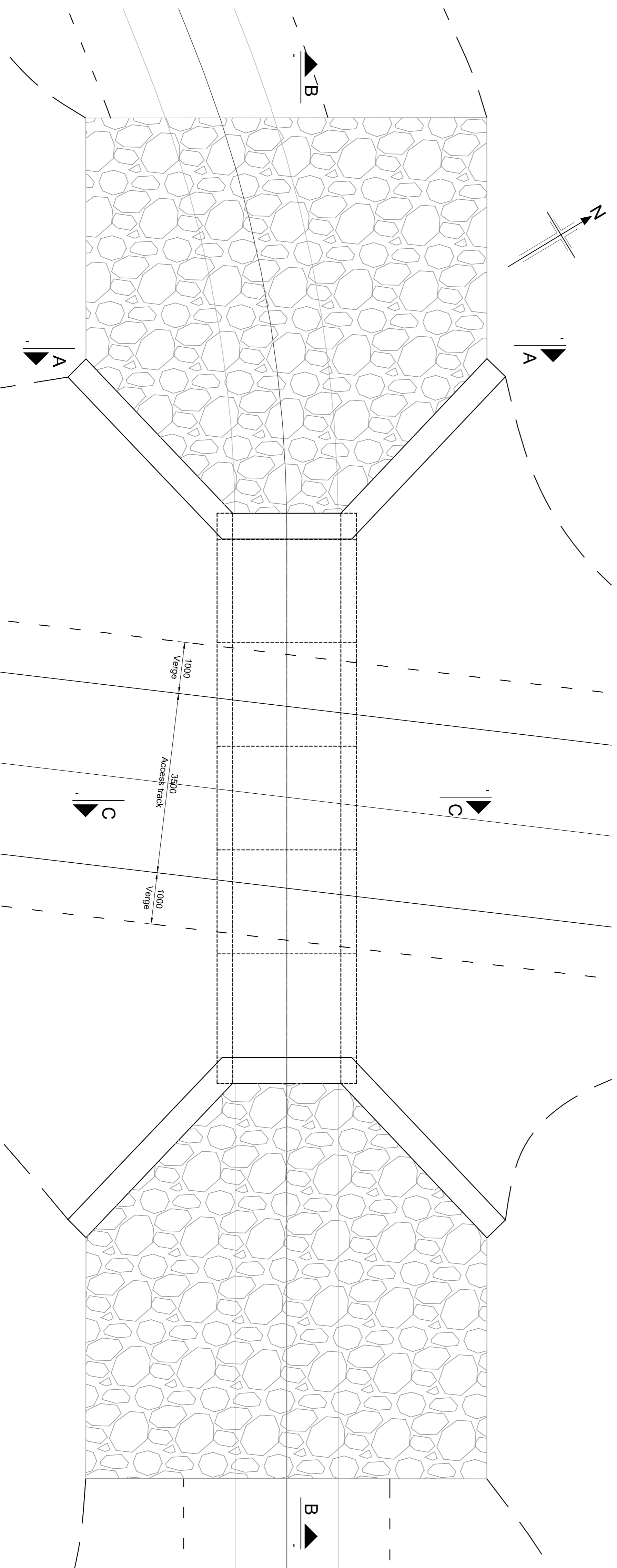

PLAN
 SCALE 1:50

- NOTES:**
1. All dimensions in millimetres unless noted otherwise.
 2. All changes are in metres unless otherwise noted.
 3. Do not scale from this drawing.
 4. All exposed areas to have 25x25 damfer unless noted otherwise.
 5. Bedding requirements in accordance with BS EN 14694 or approved equivalent.
 6. All details shown on this drawing are indicative only and subject to change at detail design stage.

Rev	Rev. Date	Purpose of revision	Drawn	Checked	Rev'd	Approved

JACOBS
 35 Bonhill St, Glasgow, G2 7HX
 Tel: +44(0)141 206 3100
 www.jacobs.com

TRANSPORT SCOTLAND
CÒR-DHÀIL ALBA

A96
DUALING
 INVERNESS TO NAIRN
 (incl. Nairn Bypass)

DMRB STAGE 3
C27 MILTON OF CULLODEN
CULVERT No.2
GENERAL ARRANGEMENT

FOR INFORMATION
 DO NOT SCALE
 Drawing number
B2103500/ST/C27/DR/001
 Rev **0**

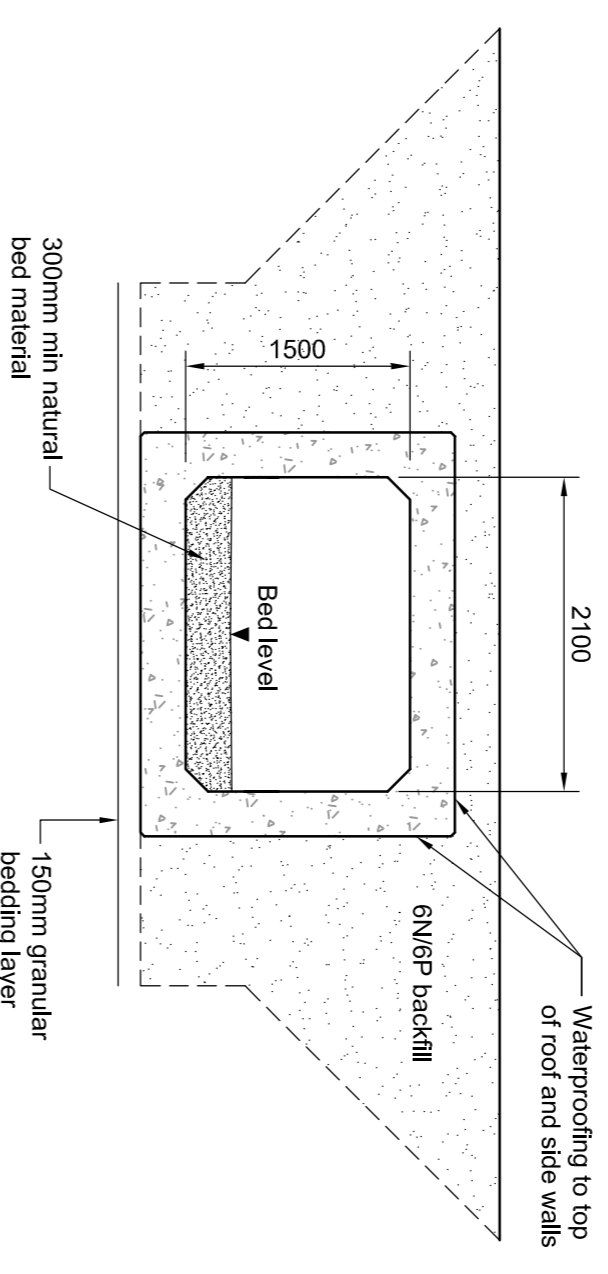
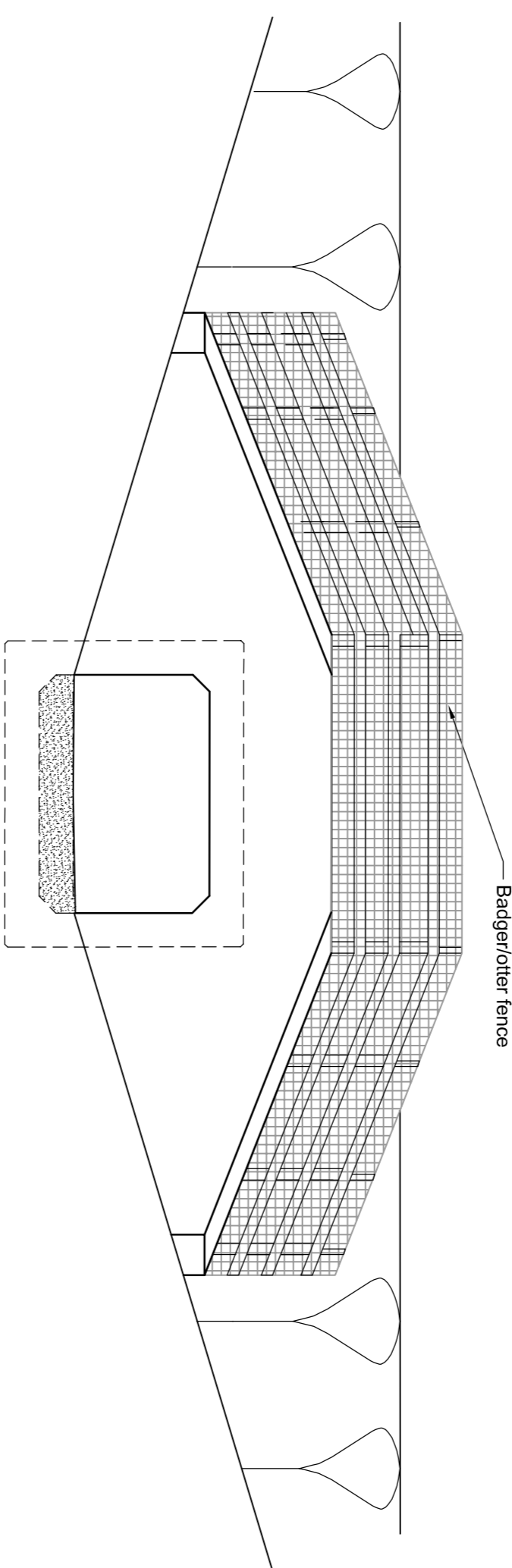
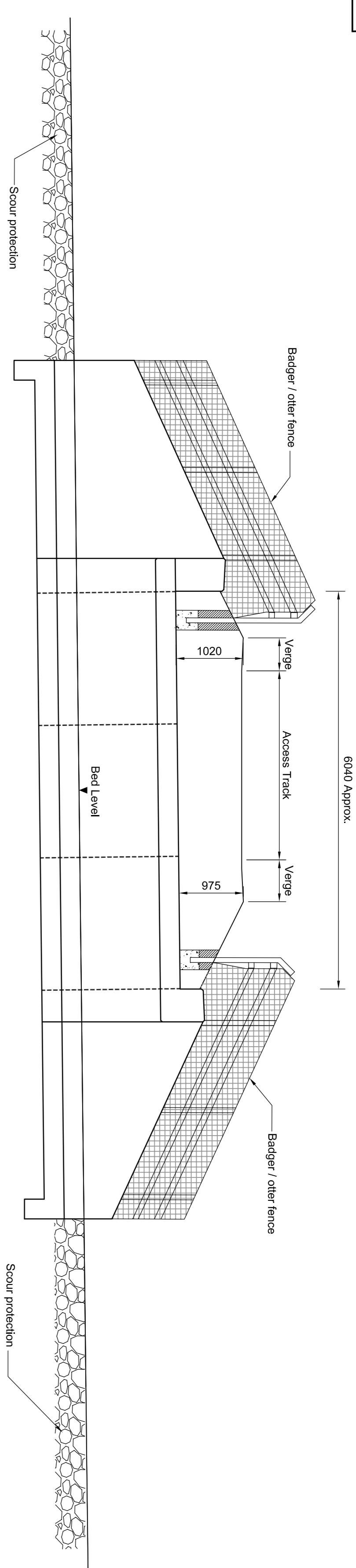

ELEVATION A-A
 SCALE 1:50

SECTION B-B
 SCALE 1:50

SECTION C-C
 SCALE 1:50

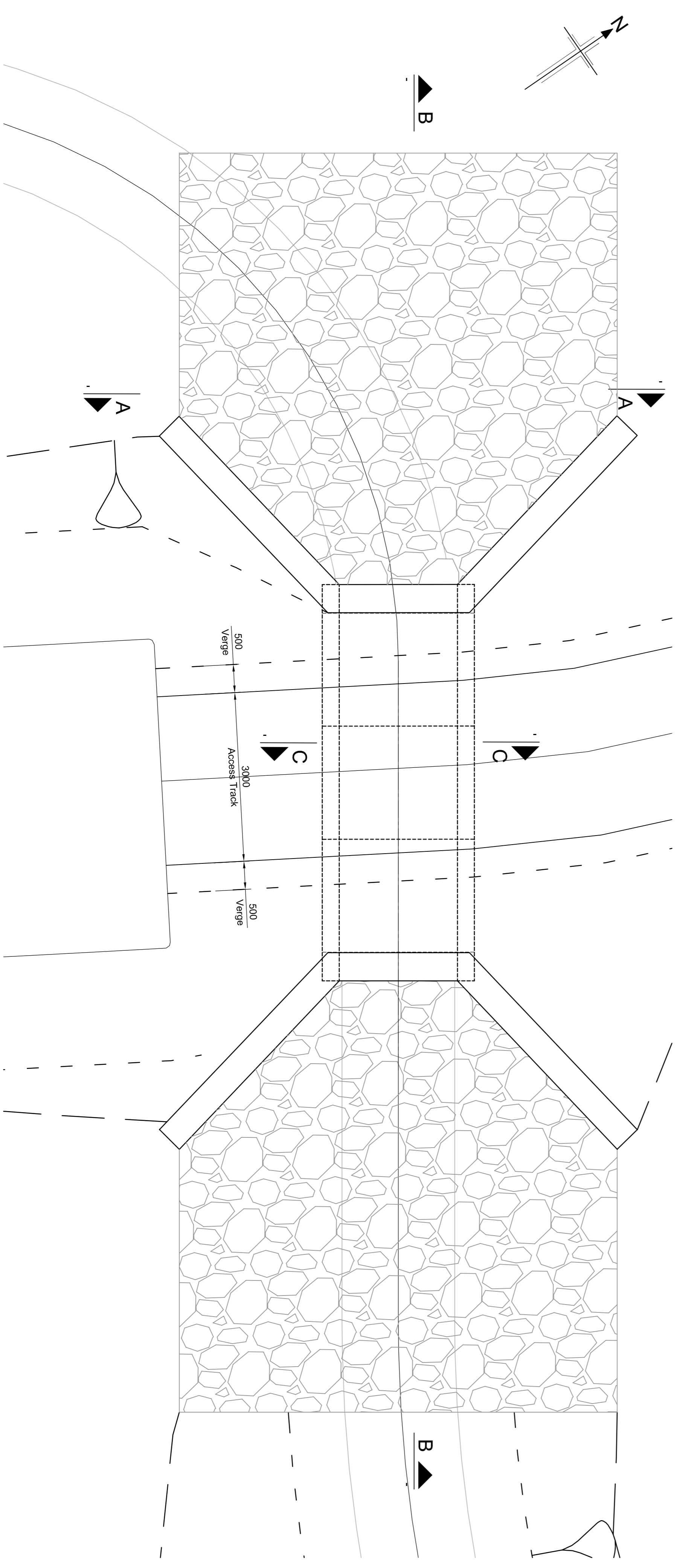

PLAN
 SCALE 1:50

- NOTES:**
1. All dimensions in millimetres unless noted otherwise.
 2. All changes are in metres unless otherwise noted.
 3. Do not scale from this drawing.
 4. All exposed areas to have 25x25 chamfer unless noted otherwise.
 5. Bedding requirements in accordance with BS EN 14694 or approved equivalent.
 6. All details shown on this drawing are indicative only and subject to change at detail design stage.

Rev	Rev. Date	Purpose of revision	Drawn	Checked	Rev'd	Approved

Client: **JACOBS**
 35 Esplanade, Glasgow, G2 7HX
 Tel: +44(0)141 209 3100
 www.jacobs.com

Project: **TRANSPORT SCOTLAND CÒR-DHAIL ALBA**

Drawing title: **DMRB STAGE 3 C29 MILTON OF CULLODEN CULVERT No.4 GENERAL ARRANGEMENT**

Drawing status: **FOR INFORMATION**

Scale	AS SHOWN @ A1	DO NOT SCALE
Jacobs No.	B2103500	
BIM no.		
Drawing number	B2103500/ST/C29/DR/001	Rev 0

This drawing is not to be used in whole or part other than for the intended purpose and project as defined on this drawing. Refer to the contract for full terms and conditions.

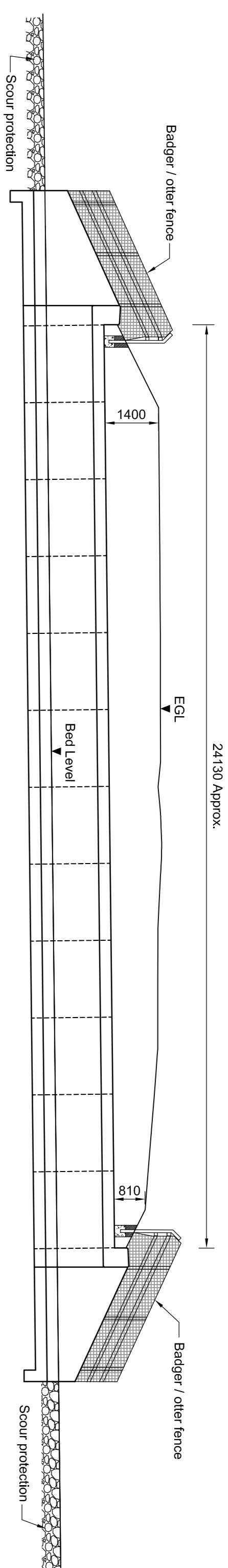

SECTION B-B
 SCALE 1:100

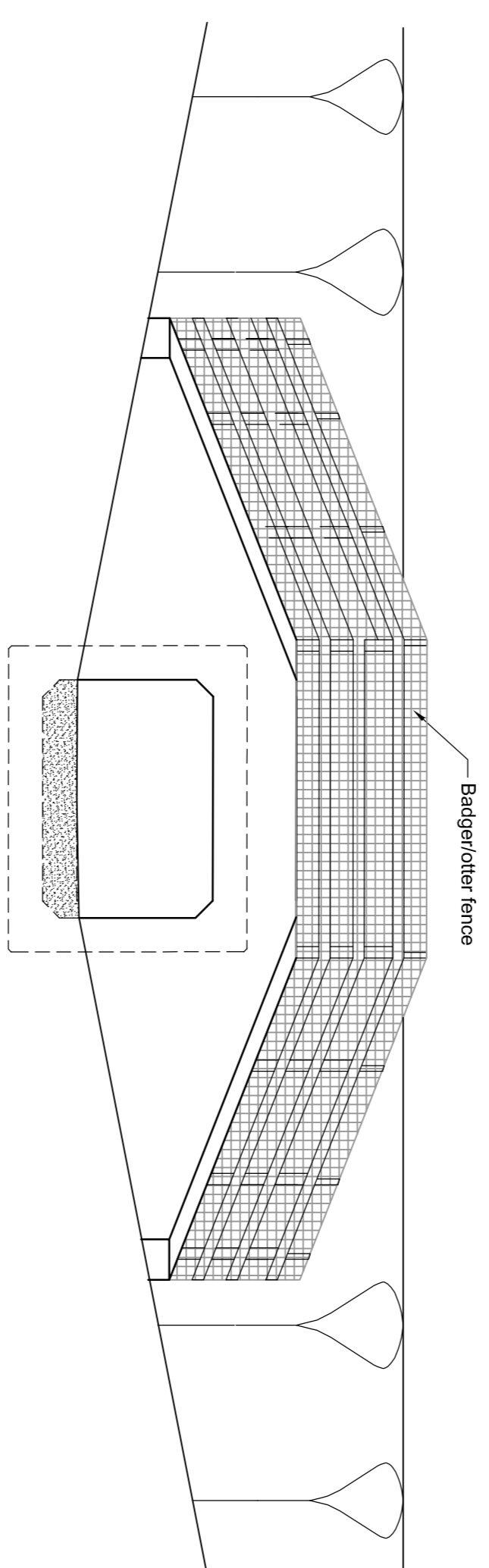

ELEVATION A-A
 SCALE 1:50

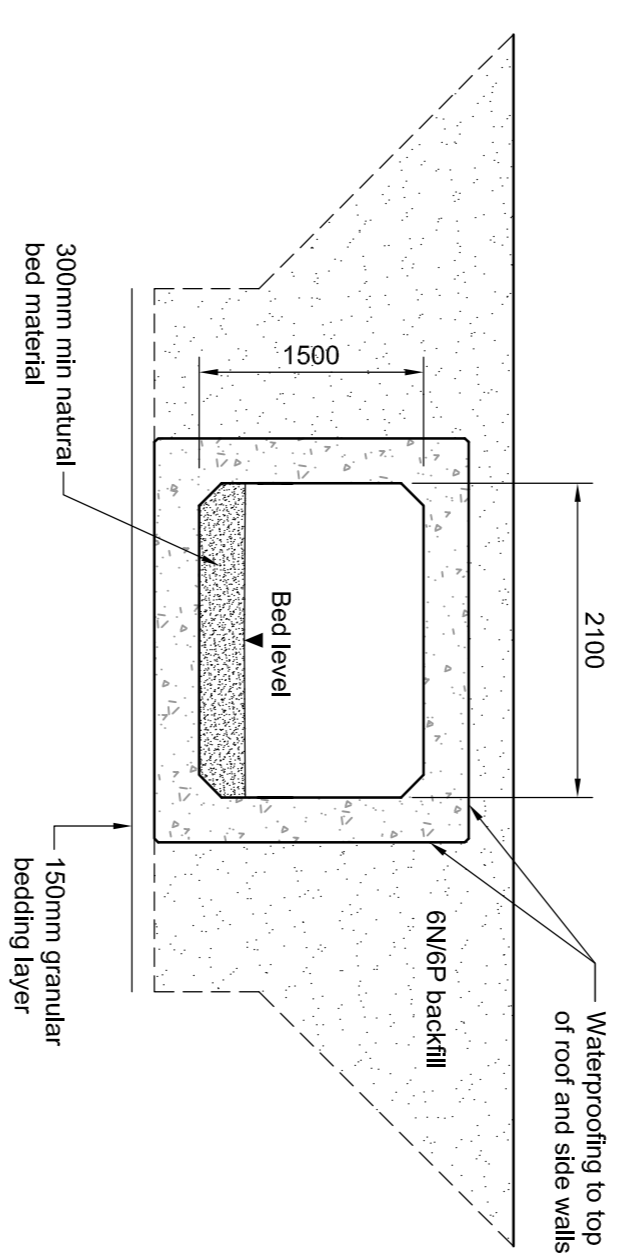

SECTION C-C
 SCALE 1:50

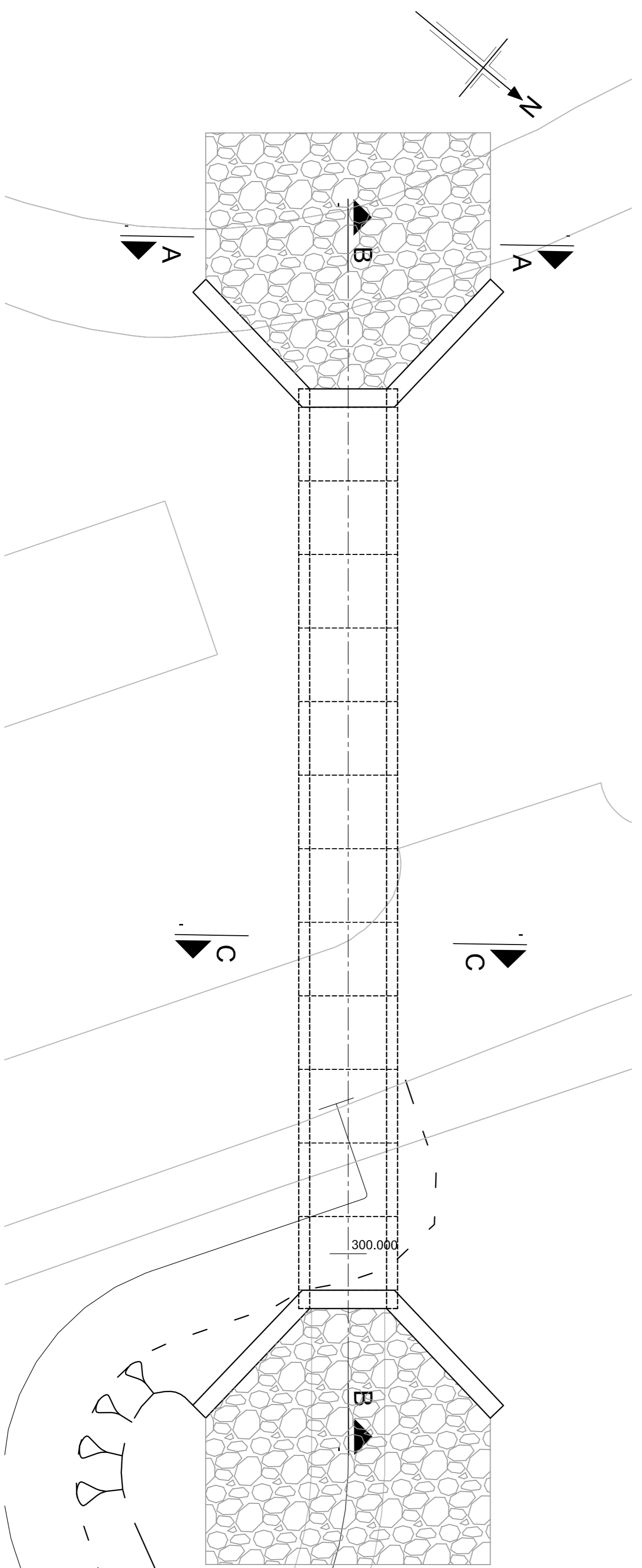

PLAN
 SCALE 1:100

- NOTES:**
1. All dimensions in millimetres unless noted otherwise.
 2. All changes are in metres unless otherwise noted.
 3. Do not scale from this drawing.
 4. All exposed areas to have 25x25 damper unless noted otherwise.
 5. Bedding requirements in accordance with BS EN 14694 or approved equivalent.
 6. All details shown on this drawing are indicative only and subject to change at detail design stage.

Rev	Rev. Date	Purpose of revision	Drawn	Checked	Rev'd	Approved

Client: **JACOBS**
 35 Bonhill St, Glasgow, G2 7HX
 Tel: +44(0)141 206 3100
 www.jacobs.com

Project: **TRANSPORT SCOTLAND CÒMHDHAL ALBA**

Drawing title: **DMRB STAGE 3 C30 MILTON OF CULLODEN CULVERT No.5 GENERAL ARRANGEMENT**

Drawing status: **FOR INFORMATION**

Scale	Jacobs No.	Rev
AS SHOWN @ A1	B2103500	DO NOT SCALE

Drawing number	Rev
B2103500/ST/C30/DR/001	0

This drawing is not to be used in whole or part other than for the intended purpose and project as defined on this drawing. Refer to the contract for full terms and conditions.

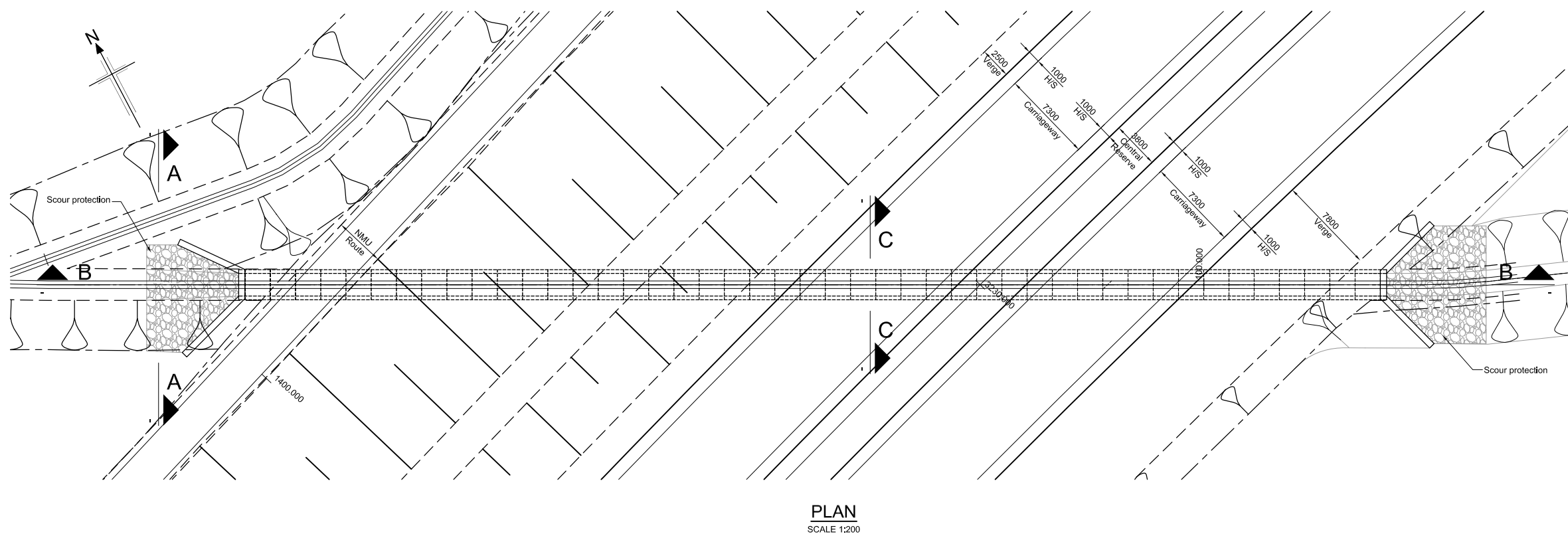
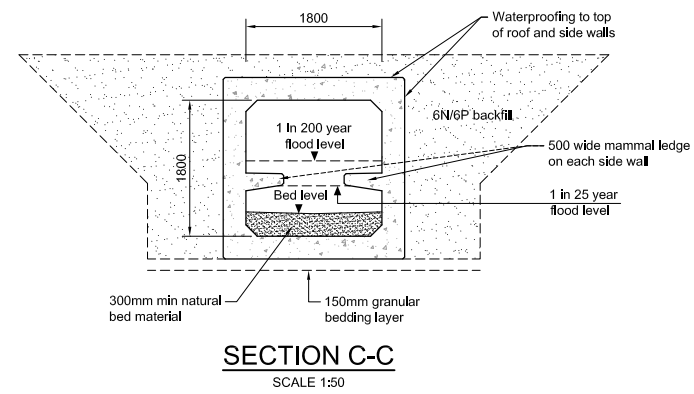
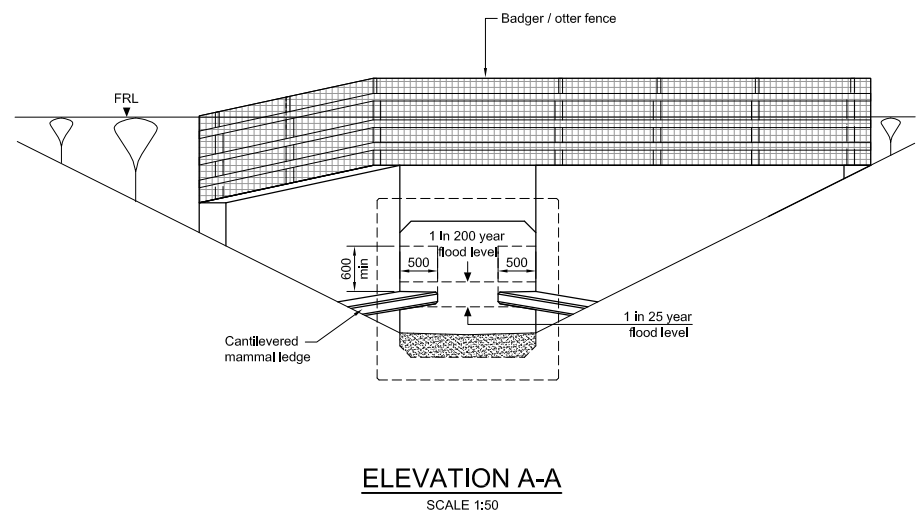
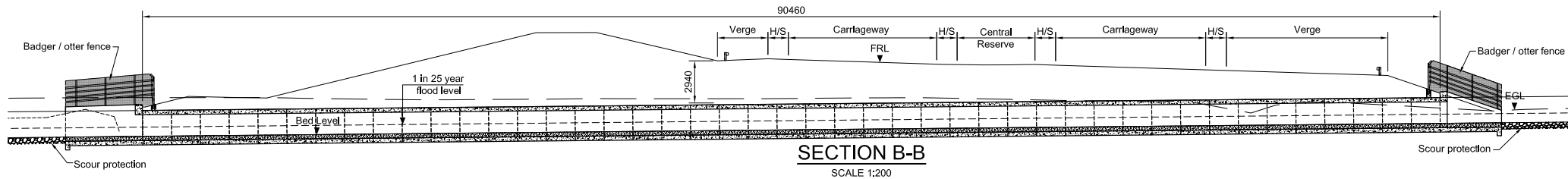

- NOTES:**
- All dimensions in millimetres unless noted otherwise.
 - All chainages are in metres unless otherwise noted.
 - Do not scale from this drawing.
 - All exposed arises to have 25x25 chamfer unless noted otherwise.
 - Bedding requirements in accordance with BS EN 14844 or approved equivalent.
 - All details shown on this drawing are indicative only and subject to change at detail design stage.

Rev	Rev. Date	Purpose of revision	Drawn	Checked	Rev'd	Apprv'd
-----	-----------	---------------------	-------	---------	-------	---------

JACOBS
 95 Bothwell St, Glasgow, G2 7HX
 Tel: +44(0)141 243 8000 Fax: +44(0)141 226 3109
 www.jacobs.com



Drawing title
**DMRB STAGE 3
 C06 ALLANFEARN DRAIN CULVERT
 GENERAL ARRANGEMENT**

Drawing status
FOR INFORMATION

Scale AS SHOWN @ A1 DO NOT SCALE

Jacobs No. B2103500

BIM no.

Drawing number **B2103500/ST/C06/DR/001** Rev **1**

This drawing is not to be used in whole or part other than for the intended purpose and project as defined on this drawing. Refer to the contract for full terms and conditions.

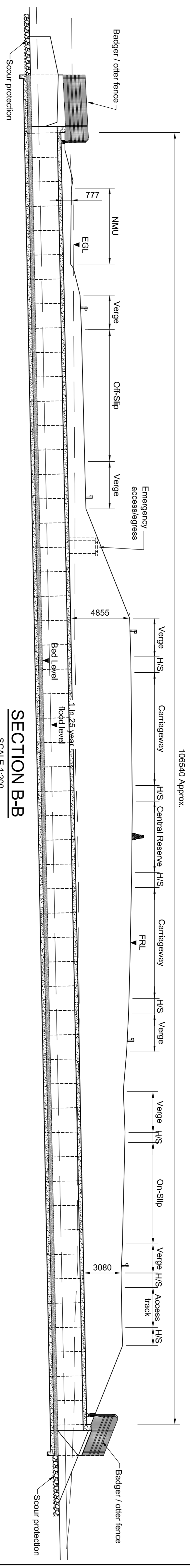

SECTION B-B
 SCALE 1:200

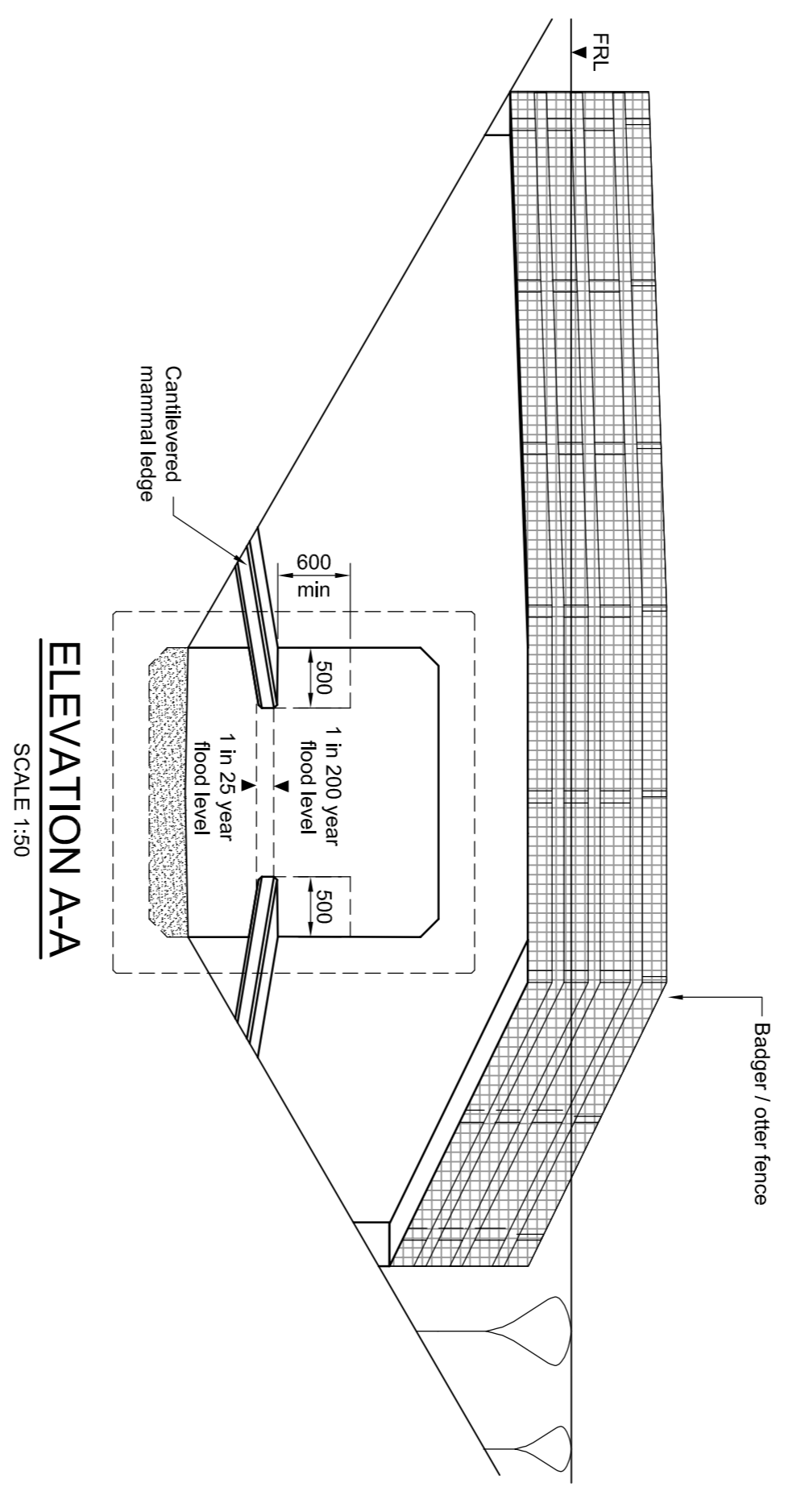

ELEVATION A-A
 SCALE 1:50

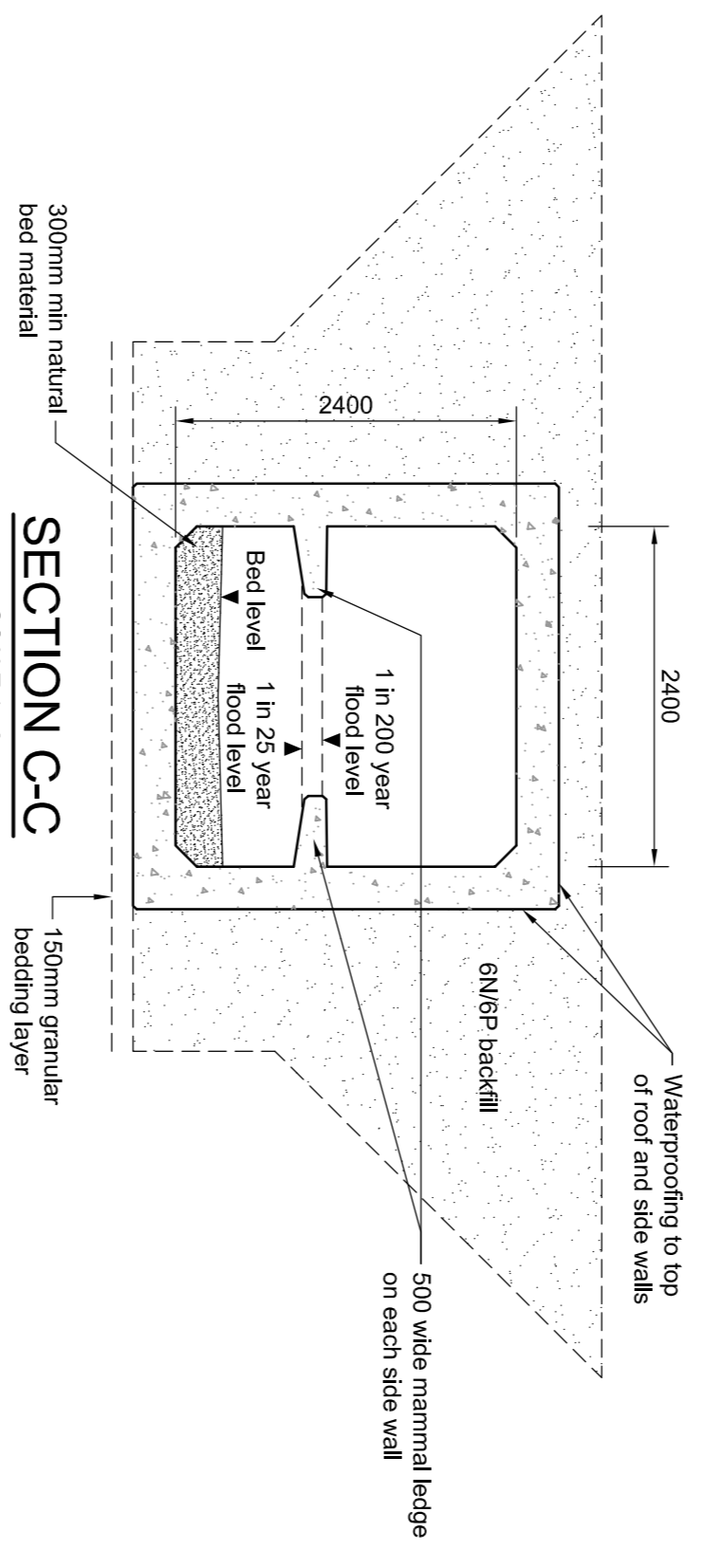

SECTION C-C
 SCALE 1:50

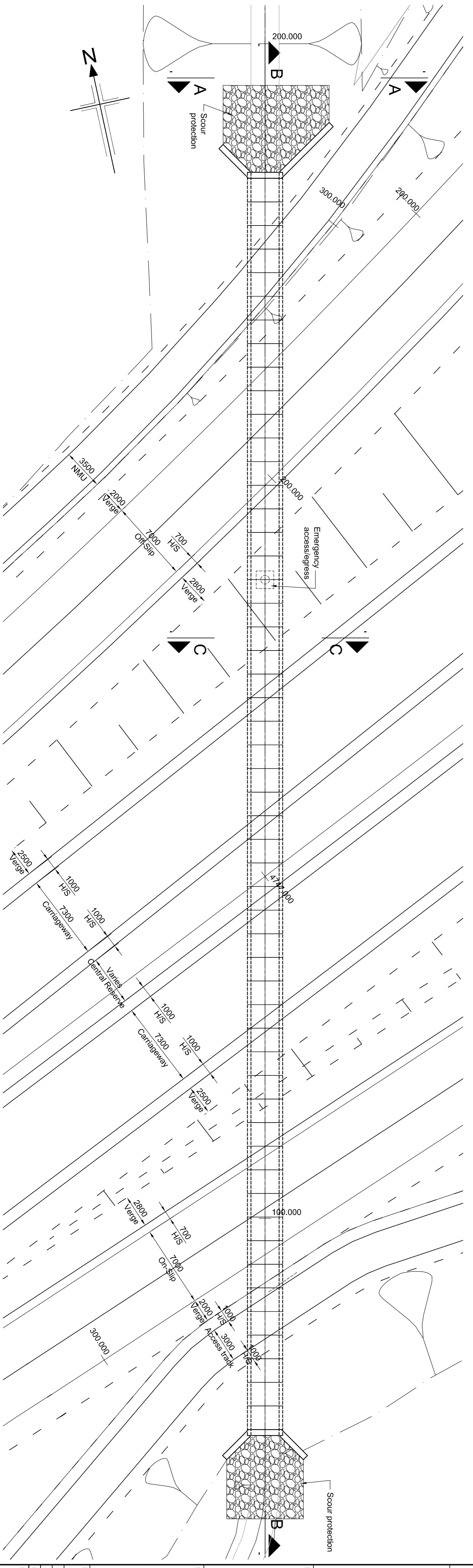

PLAN
 SCALE 1:200

- NOTES:**
1. All dimensions in millimetres unless noted otherwise.
 2. All changes are in metres unless otherwise noted.
 3. Do not scale from this drawing.
 4. All exposed assets to have 25x25 damper unless noted otherwise.
 5. Bedding requirements in accordance with BS EN 14644 or approved equivalent.
 6. All details shown on this drawing are indicative only and subject to change at detail design stage.

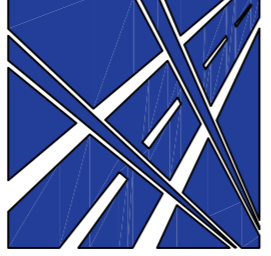
Client	 35 Bonhill St, Glasgow, G2 7HX Tel: +44(0)141 206 1144 Fax: +44(0)141 206 3109 www.jacobs.com		
Project	 TRANSPORT SCOTLAND CÒR-DHAIL ALBA		
Drawing title	DMRB STAGE 3 C07 FIDDLER'S BURN CULVERT GENERAL ARRANGEMENT		
Drawing status	FOR INFORMATION		
Scale	AS SHOWN @ A1	DO NOT SCALE	
Jacobs No.	B2103500		
Bill no.			
Drawing number	B2103500/ST/C07/DR/001	Rev	1

This drawing is not to be used in whole or part other than for the intended purpose and project as defined on this drawing. Refer to the contract for full terms and conditions.

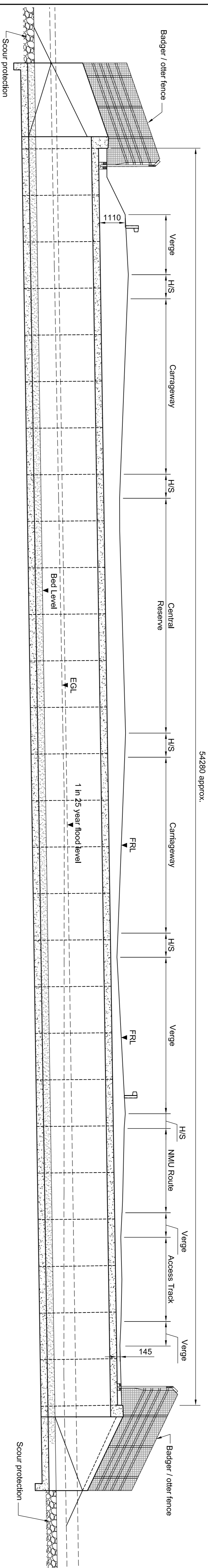

SECTION B-B
 SCALE 1:100

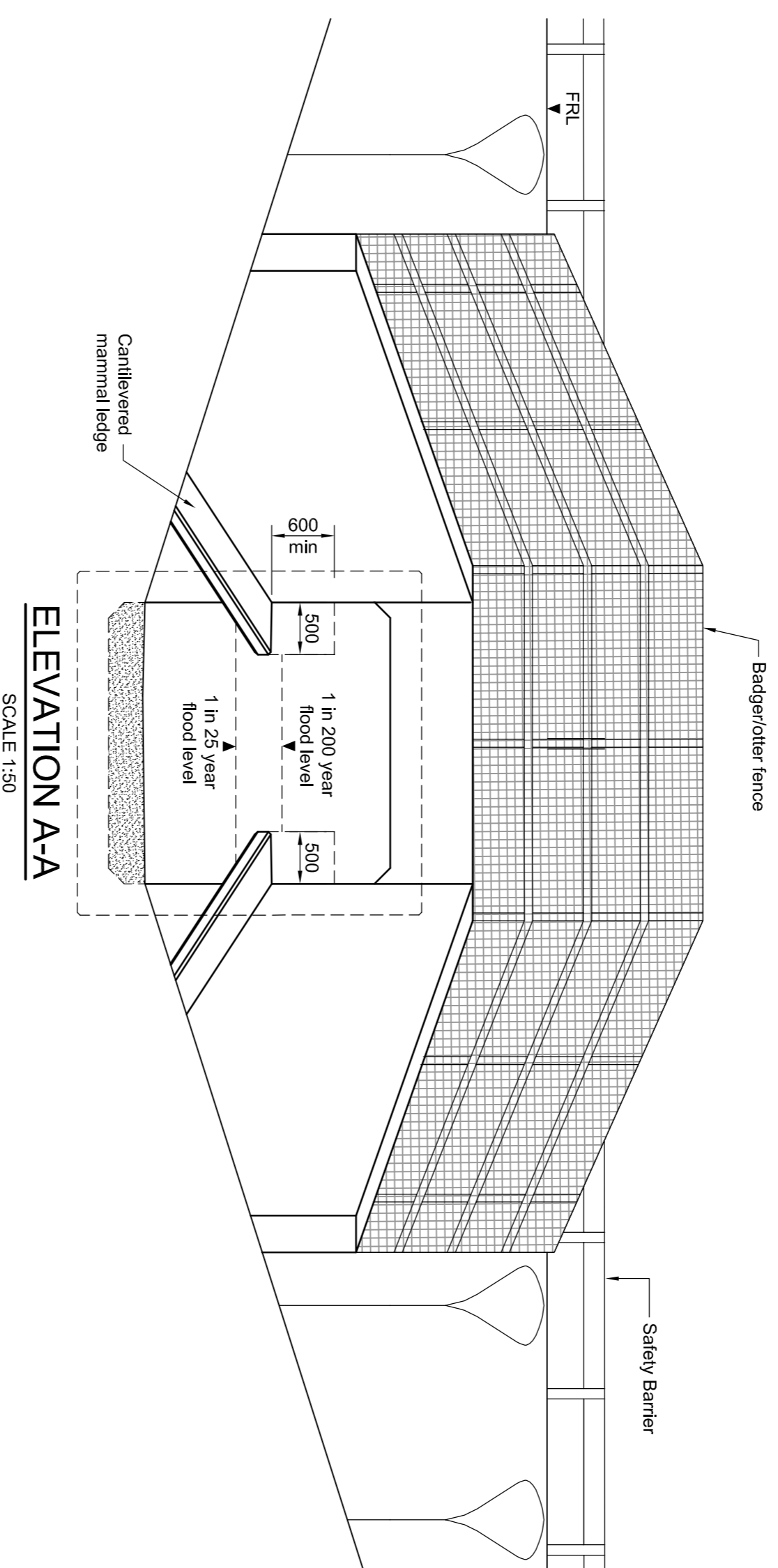

ELEVATION AA
 SCALE 1:50

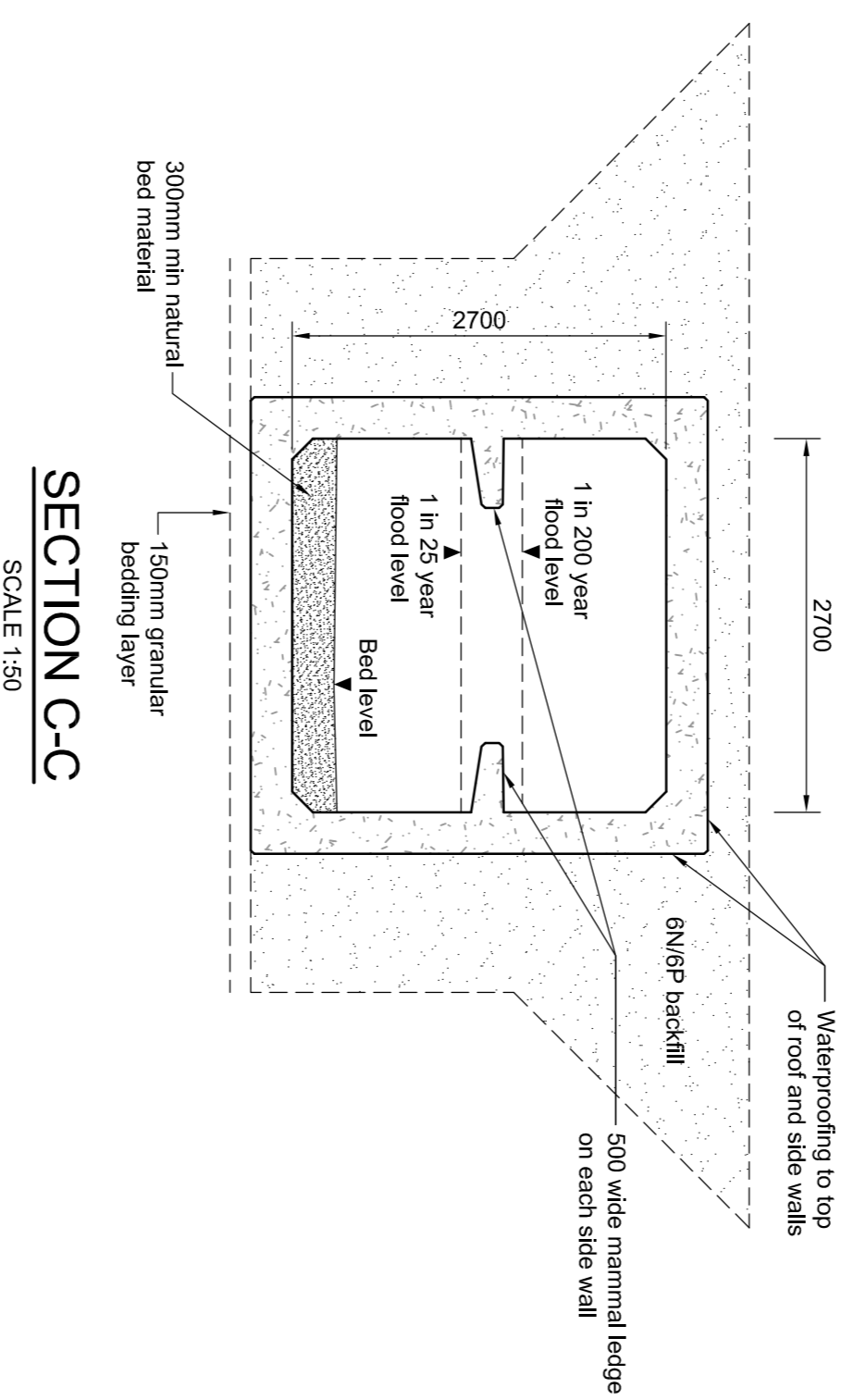

SECTION C-C
 SCALE 1:50

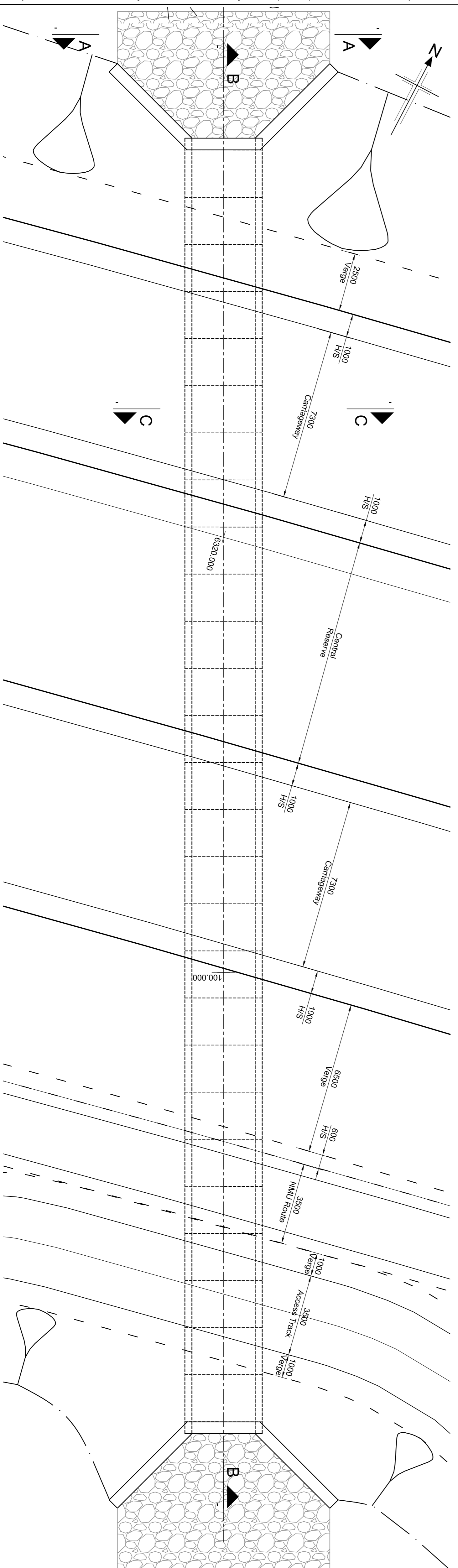

PLAN
 SCALE 1:100

- NOTES:**
1. All dimensions in millimetres unless noted otherwise.
 2. All changes are in metres unless otherwise noted.
 3. Do not scale from this drawing.
 4. All exposed assets to have 25x25 chamfer unless noted otherwise.
 5. Bedding requirements in accordance with BS EN 14644 or approved equivalent.
 6. All details shown on this drawing are indicative only and subject to change at detail design stage.

Rev	Rev. Date	Purpose of revision	Drawn	Checked	Rev'd	Approved

Client: **JACOBS**
 35 Bonhill St, Glasgow, G2 7HX
 Tel: +44(0)141 206 3100
 www.jacobs.com

Project: **DMRB STAGE 3
 C08 NEWTON BURN TRIBUTARY
 CULVERT
 GENERAL ARRANGEMENT**

Drawing title: **DMRB STAGE 3
 C08 NEWTON BURN TRIBUTARY
 CULVERT
 GENERAL ARRANGEMENT**

FOR INFORMATION
 AS SHOWN @ A1
 DO NOT SCALE

Drawing number: **B2103500/ST/C08/DR/001**

Scale: **AS SHOWN @ A1**

Jacobs No.: **B2103500**

Rev: **1**

This drawing is not to be used in whole or part other than for the intended purpose and project as defined on this drawing. Refer to the contract for full terms and conditions.

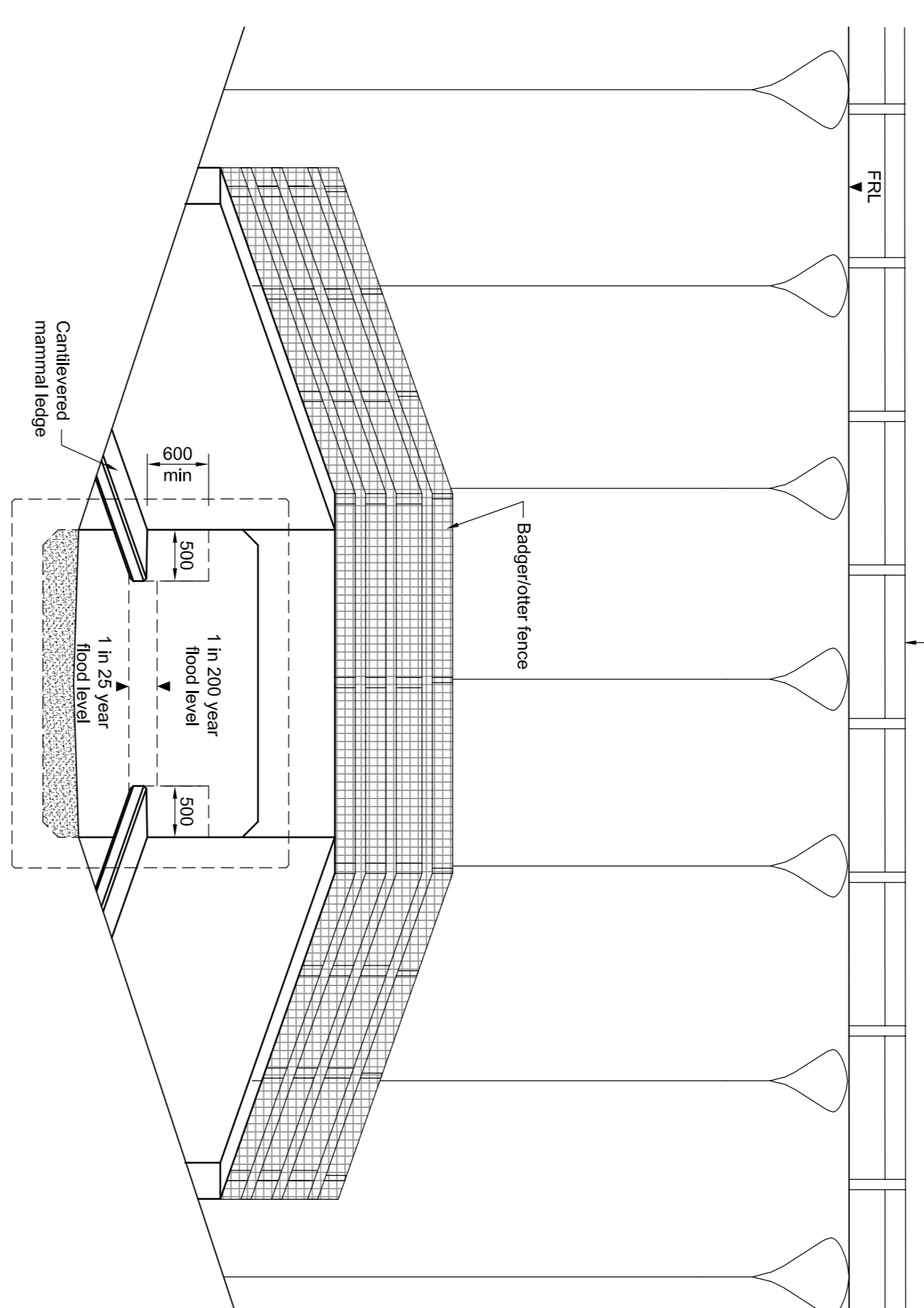
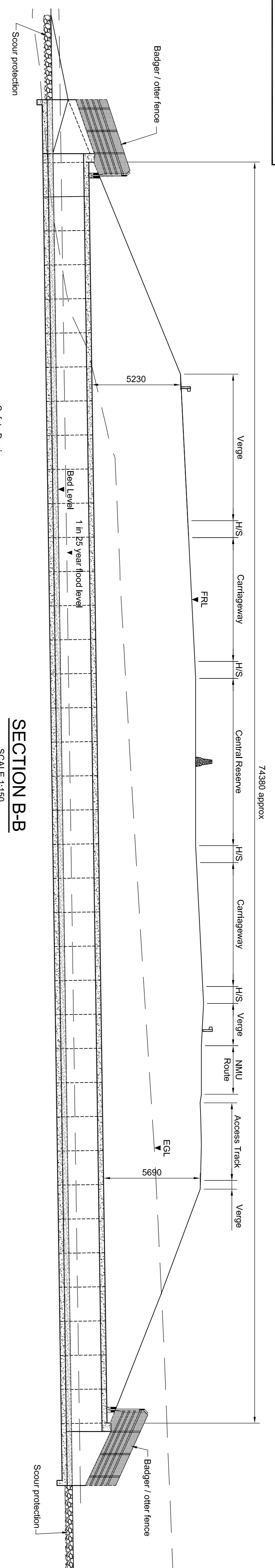

ELEVATION A-A
 SCALE 1:50

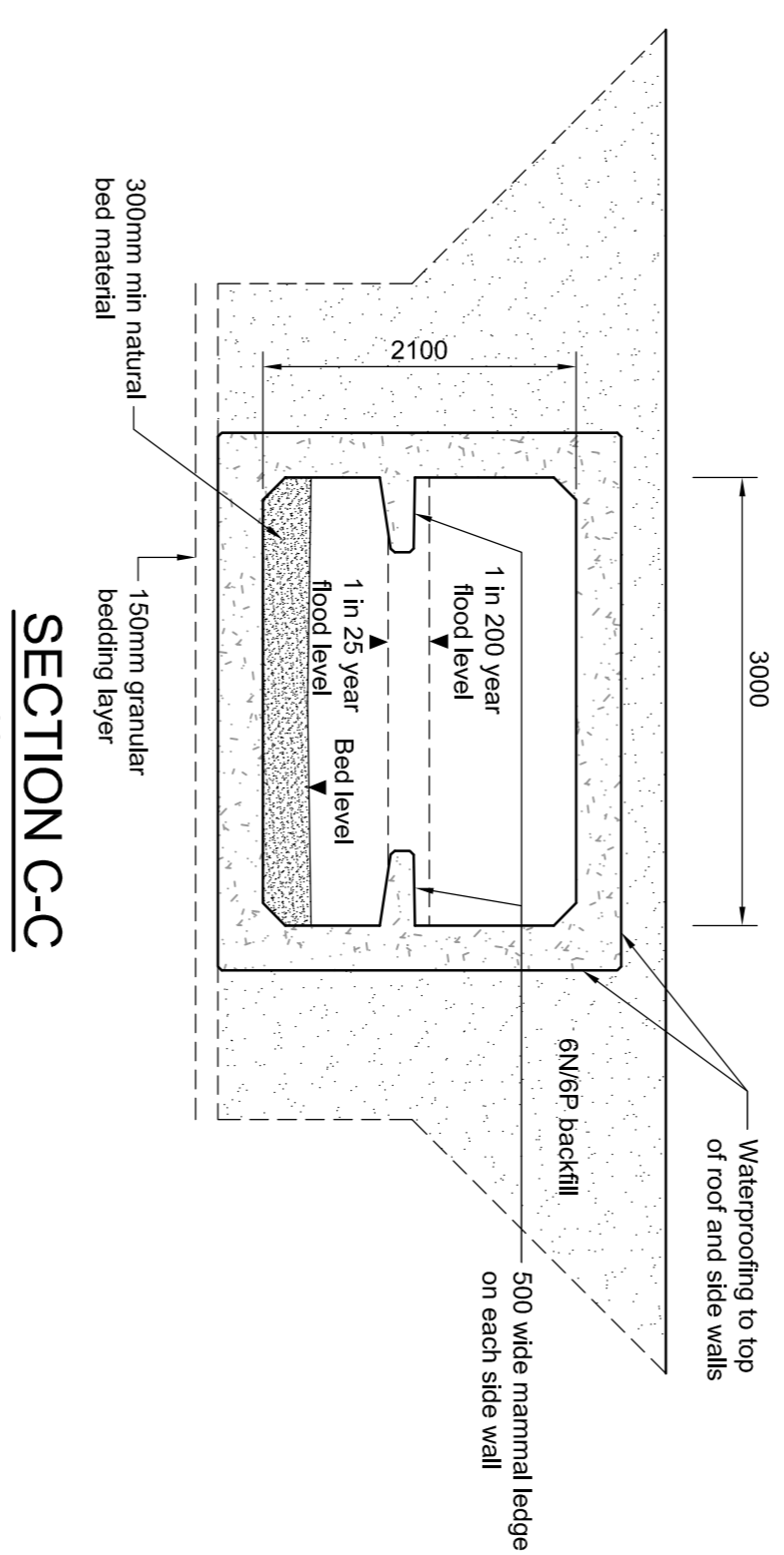

SECTION C-C
 SCALE 1:50

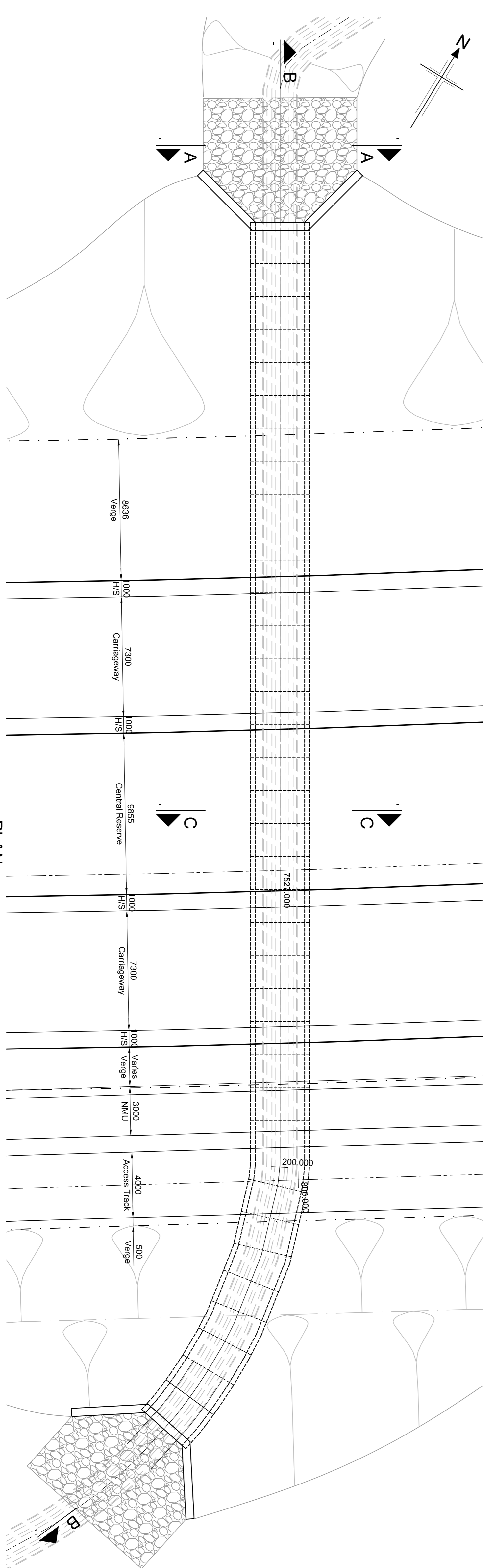

PLAN
 SCALE 1:150

- NOTES:**
1. All dimensions in millimetres unless noted otherwise.
 2. All changes are in metres unless otherwise noted.
 3. Do not scale from this drawing.
 4. All exposed assets to have 25x25 diamfer unless noted otherwise.
 5. Bedding requirements in accordance with BS EN 14644 or approved equivalent.
 6. All details shown on this drawing are indicative only and subject to change at detail design stage.

Rev	Rev. Date	Purpose of revision	Drawn	Checked	Rev'd	Approved

Client: **JACOBS**
 35 Bonhill St, Glasgow, G2 7HX
 Tel: +44(0)141 226 9109
 www.jacobs.com

Project: **TRANSPORT SCOTLAND CÒMHDHAL ALBA**

Drawing title: **DMRB STAGE 3 C09 ROUGH BURN CULVERT GENERAL ARRANGEMENT**

Drawing status: **FOR INFORMATION**

Scale: **AS SHOWN @ A1** DO NOT SCALE

Jacobs No.: **B2103500**

Bill no.: **B2103500/ST/C09/DR/001**

Drawing number: **B2103500/ST/C09/DR/001**

Rev: **0**

This drawing is not to be used in whole or part other than for the intended purpose and project as defined on this drawing. Refer to the contract for full terms and conditions.

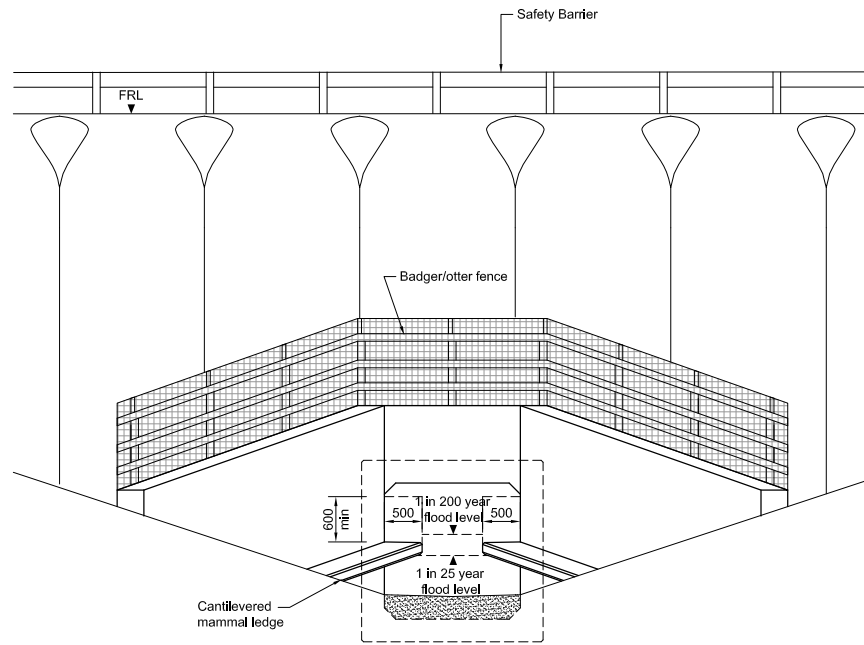
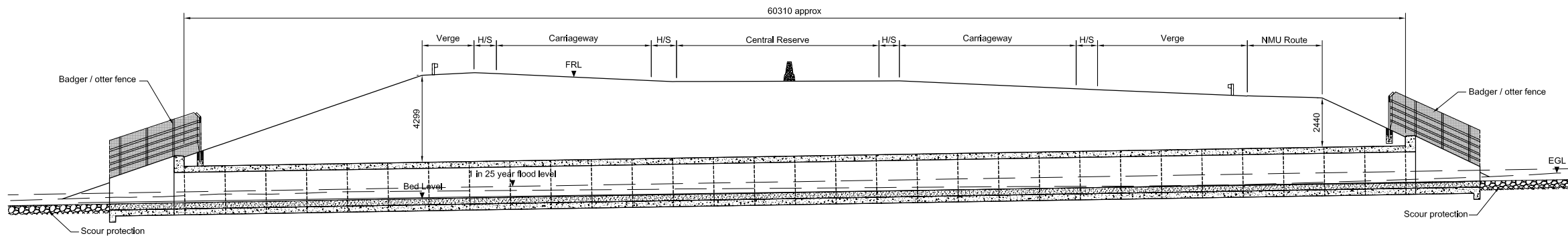

ELEVATION A-A
 SCALE 1:50

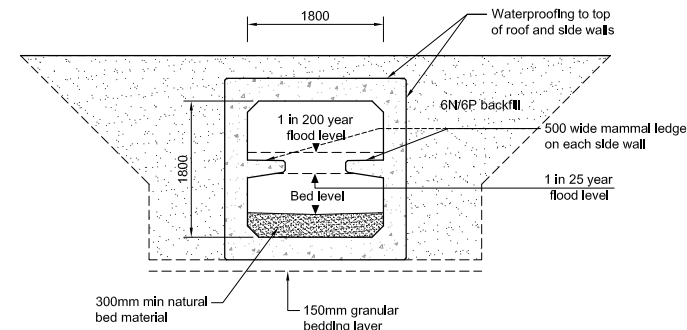

SECTION C-C
 SCALE 1:50

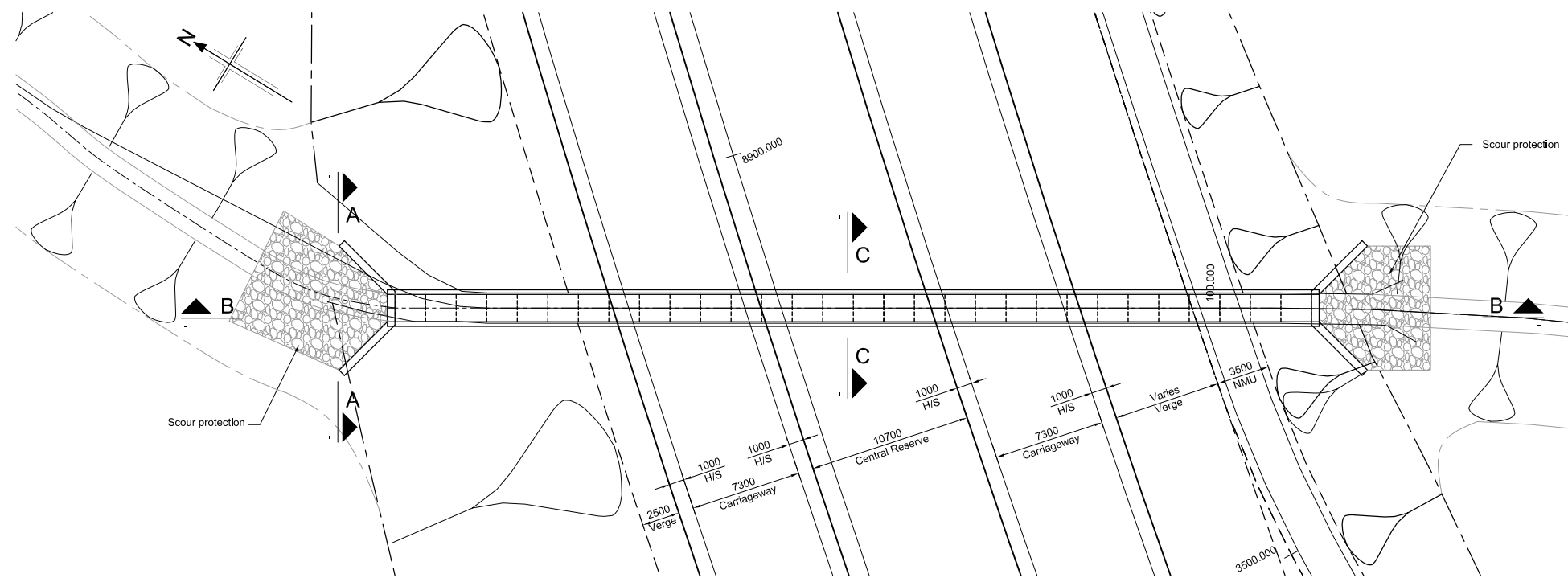

PLAN
 SCALE 1:200

- NOTES:**
- All dimensions in millimetres unless noted otherwise.
 - All chainages are in metres unless otherwise noted.
 - Do not scale from this drawing.
 - All exposed arises to have 25x25 chamfer unless noted otherwise.
 - Bedding requirements in accordance with BS EN 14844 or approved equivalent.
 - All details shown on this drawing are indicative only and subject to change at detail design stage.

Rev	Rev. Date	Purpose of revision	Drawn	Checked	Rev'd	Apprv'd
-----	-----------	---------------------	-------	---------	-------	---------

JACOBS
 95 Bothwell St, Glasgow, G2 7HX
 Tel: +44(0)141 243 8000 Fax: +44(0)141 226 3109
 www.jacobs.com



**DMRB STAGE 3
 C10 KERROWAIRD CULVERT
 GENERAL ARRANGEMENT**

Drawing status		
FOR INFORMATION		
Scale	AS SHOWN @ A1	DO NOT SCALE
Jacobs No.	B2103500	
BIM no.		
Drawing number	B2103500/ST/C10/DR/001	Rev
		1

This drawing is not to be used in whole or part other than for the intended purpose and project as defined on this drawing. Refer to the contract for full terms and conditions.

File: P:\Data\B2103500 - A96 Inverness to Nairn Inc\Nairn bypass\Structures\CAD\Culverts\C10 Kerrowaird Culvert SWF 13-11B2103500-ST-C10-DR-001 Rev 1.dwg Date: May 31, 2016 - 3:51pm Plotted by: adamb

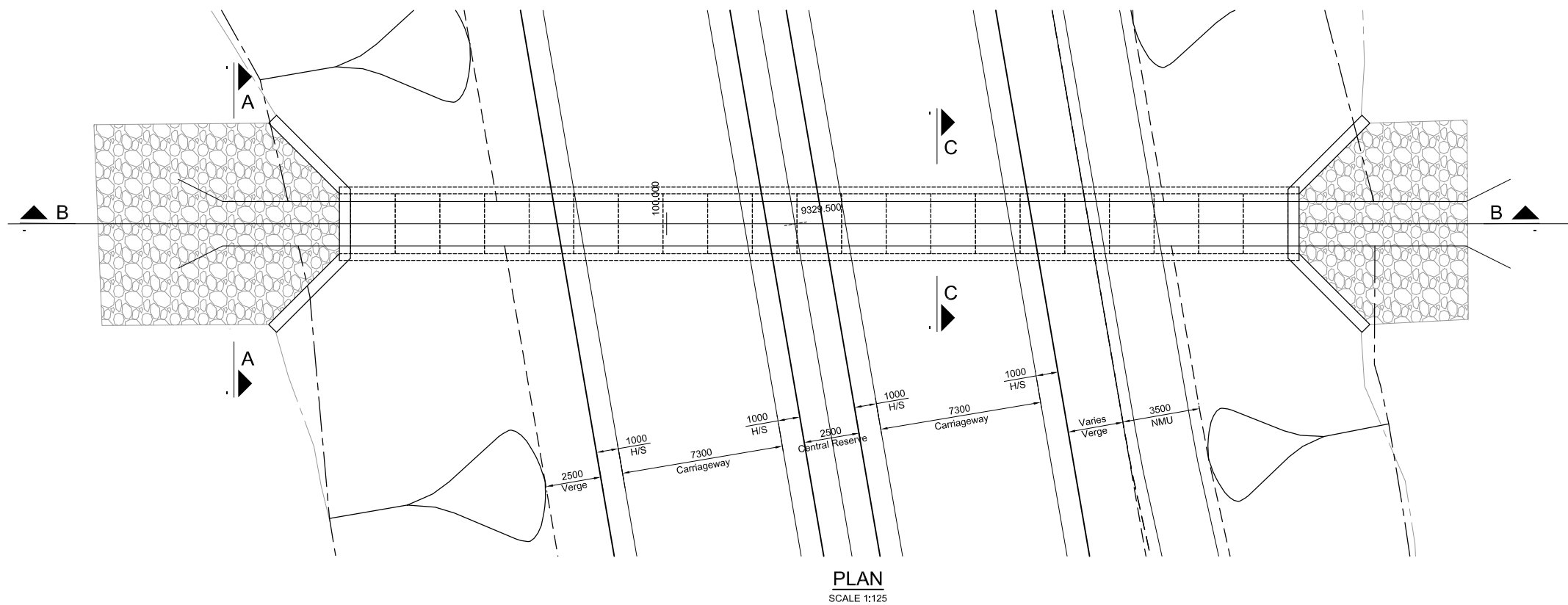
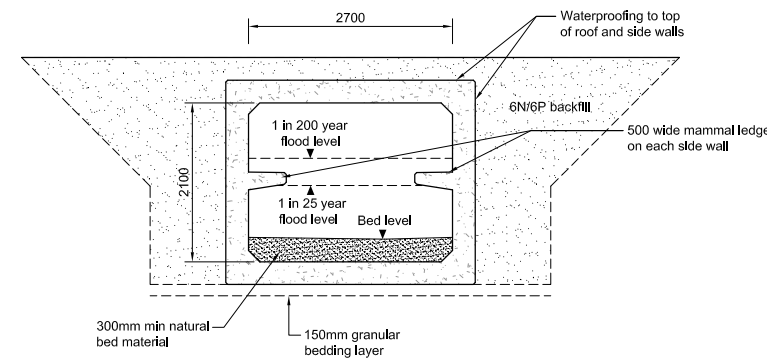
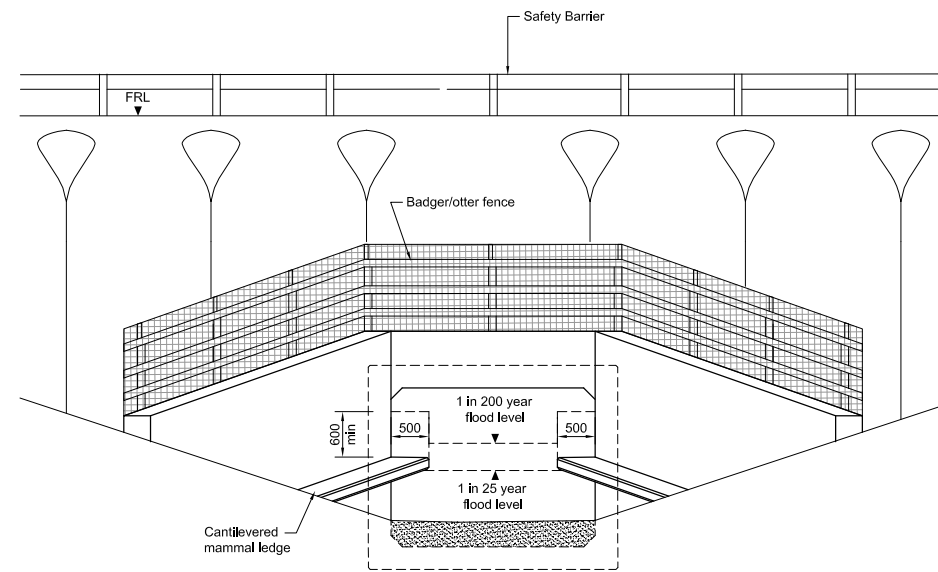
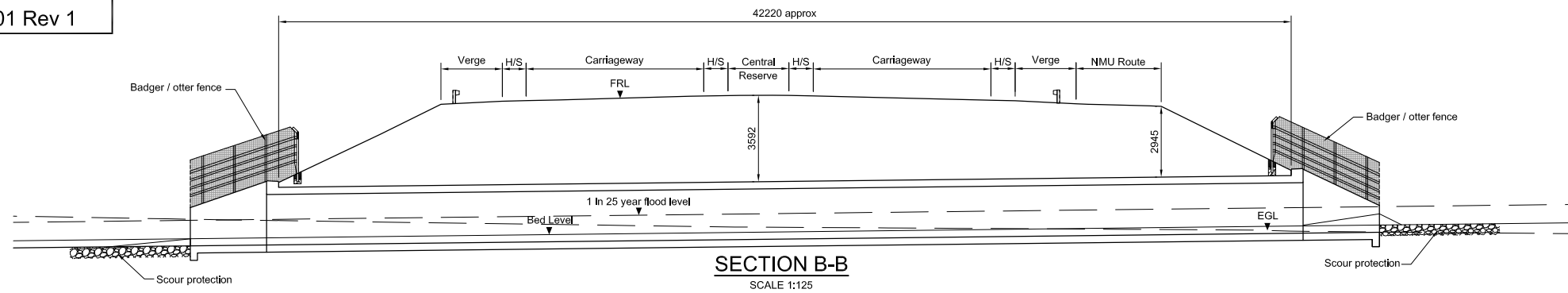

- NOTES:**
- All dimensions in millimetres unless noted otherwise.
 - All chainages are in metres unless otherwise noted.
 - Do not scale from this drawing.
 - All exposed arises to have 25x25 chamfer unless noted otherwise.
 - Bedding requirements in accordance with BS EN 14844 or approved equivalent.
 - All details shown on this drawing are indicative only and subject to change at detail design stage.

Rev	Rev. Date	Purpose of revision	Drawn	Checked	Rev'd	Apprv'd
-----	-----------	---------------------	-------	---------	-------	---------

JACOBS
 95 Bothwell St, Glasgow, G2 7HX
 Tel: +44(0)141 243 8000 Fax: +44(0)141 226 3109
 www.jacobs.com



**DMRB STAGE 3
 C11 TORNAGRAIN FARM CULVERT
 GENERAL ARRANGEMENT**

Drawing status		FOR INFORMATION
Scale	AS SHOWN @ A1	DO NOT SCALE
Jacobs No.	B2103500	
BIM no.		

Drawing number	B2103500/ST/C11/DR/001	Rev	1
----------------	------------------------	-----	---

This drawing is not to be used in whole or part other than for the intended purpose and project as defined on this drawing. Refer to the contract for full terms and conditions.

File: P:\Data\B2103500 - A95 Inverness to Nairn Inc\Nairn bypass\Structures\CAD\Culverts\C11 Tornagrain Farm Culvert SWF 14-11B2103500-ST-C11-DR-001 Rev 1.dwg Date: Jun 01, 2016 - 10:48am Plotted by: adamb

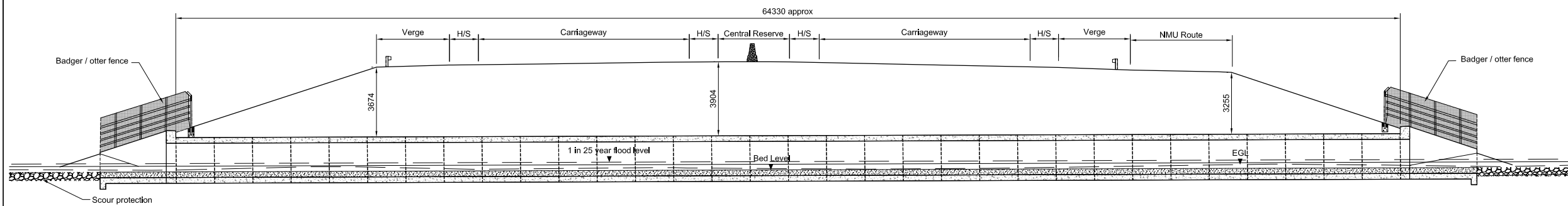

SECTION B-B
 SCALE 1:125

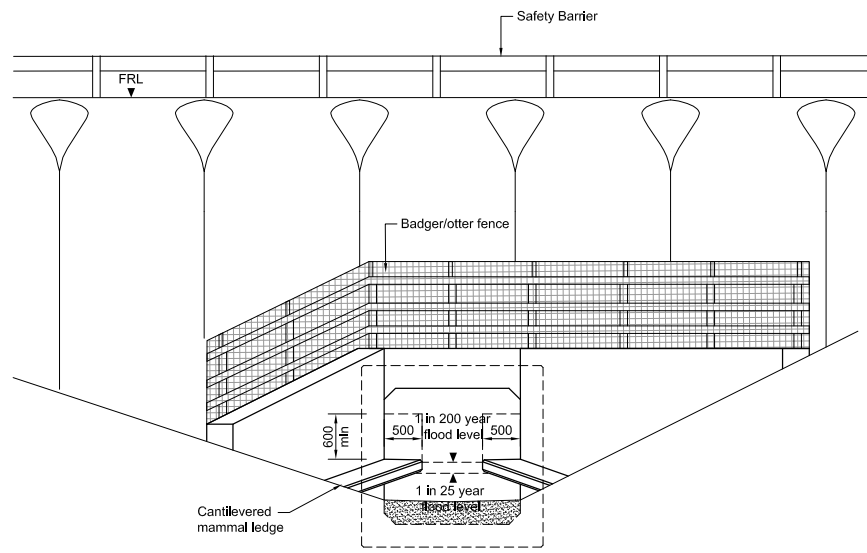

ELEVATION A-A
 SCALE 1:50

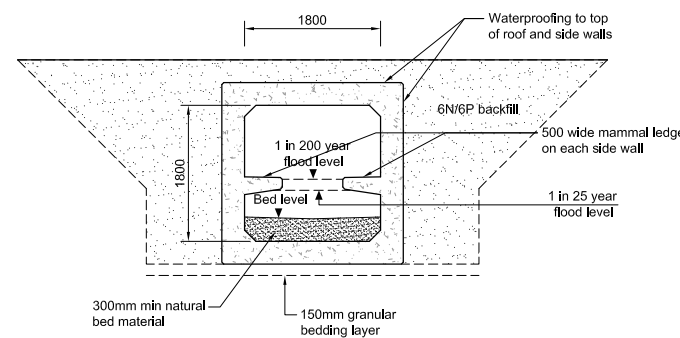

SECTION C-C
 SCALE 1:50

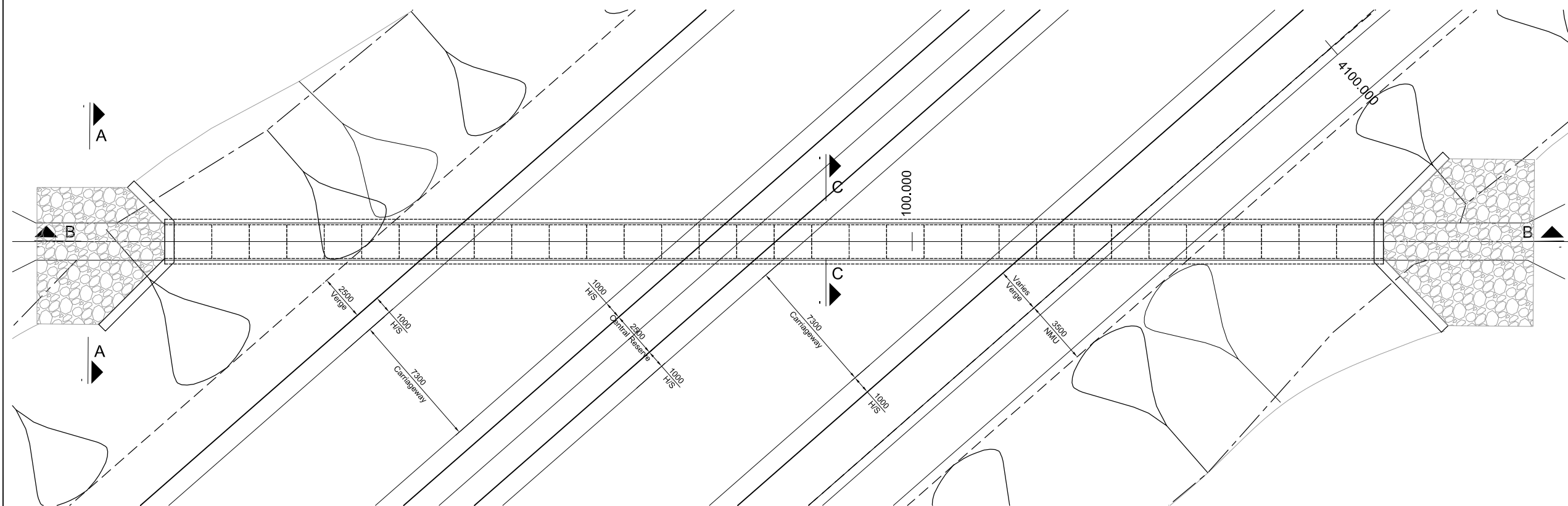

PLAN
 SCALE 1:125

- NOTES:**
- All dimensions in millimetres unless noted otherwise.
 - All chainages are in metres unless otherwise noted.
 - Do not scale from this drawing.
 - All exposed arises to have 25x25 chamfer unless noted otherwise.
 - Bedding requirements in accordance with BS EN 14844 or approved equivalent.
 - All details shown on this drawing are indicative only and subject to change at detail design stage.

Rev	Rev. Date	Purpose of revision	Drawn	Checked	Rev'd	Apprv'd
-----	-----------	---------------------	-------	---------	-------	---------

JACOBS
 95 Bothwell St, Glasgow, G2 7HX
 Tel: +44(0)141 243 8000 Fax: +44(0)141 226 3109
 www.jacobs.com

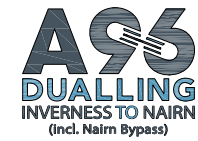

**DMRB STAGE 3
 C12 TORNAGRAIN WOOD CULVERT
 GENERAL ARRANGEMENT**

Drawing status: **FOR INFORMATION**

Scale	AS SHOWN @ A1	DO NOT SCALE
Jacobs No.	B2103500	
BIM no.		

Drawing number	B2103500/ST/C12/DR/001	Rev	1
----------------	-------------------------------	-----	----------

This drawing is not to be used in whole or part other than for the intended purpose and project as defined on this drawing. Refer to the contract for full terms and conditions.

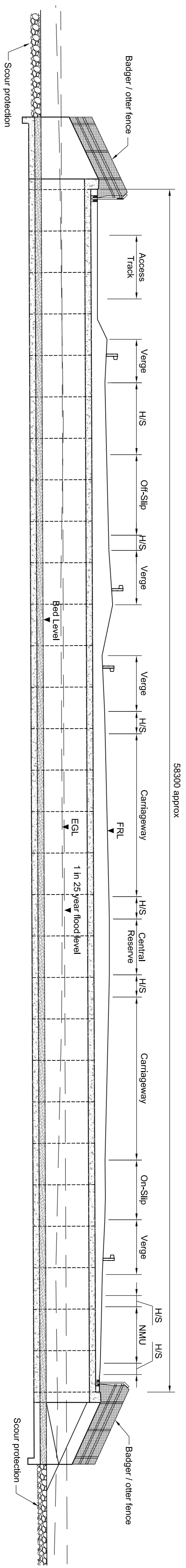

SECTION B-B
 SCALE 1:125

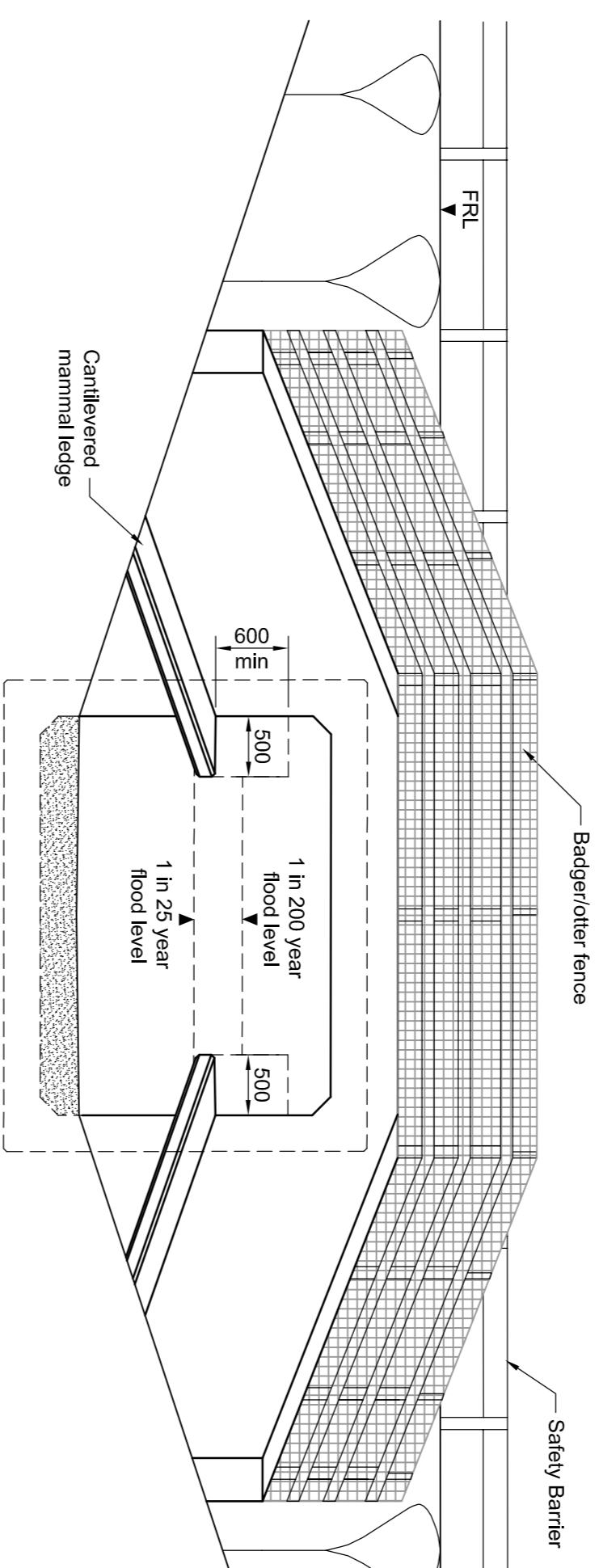

ELEVATION AA
 SCALE 1:50

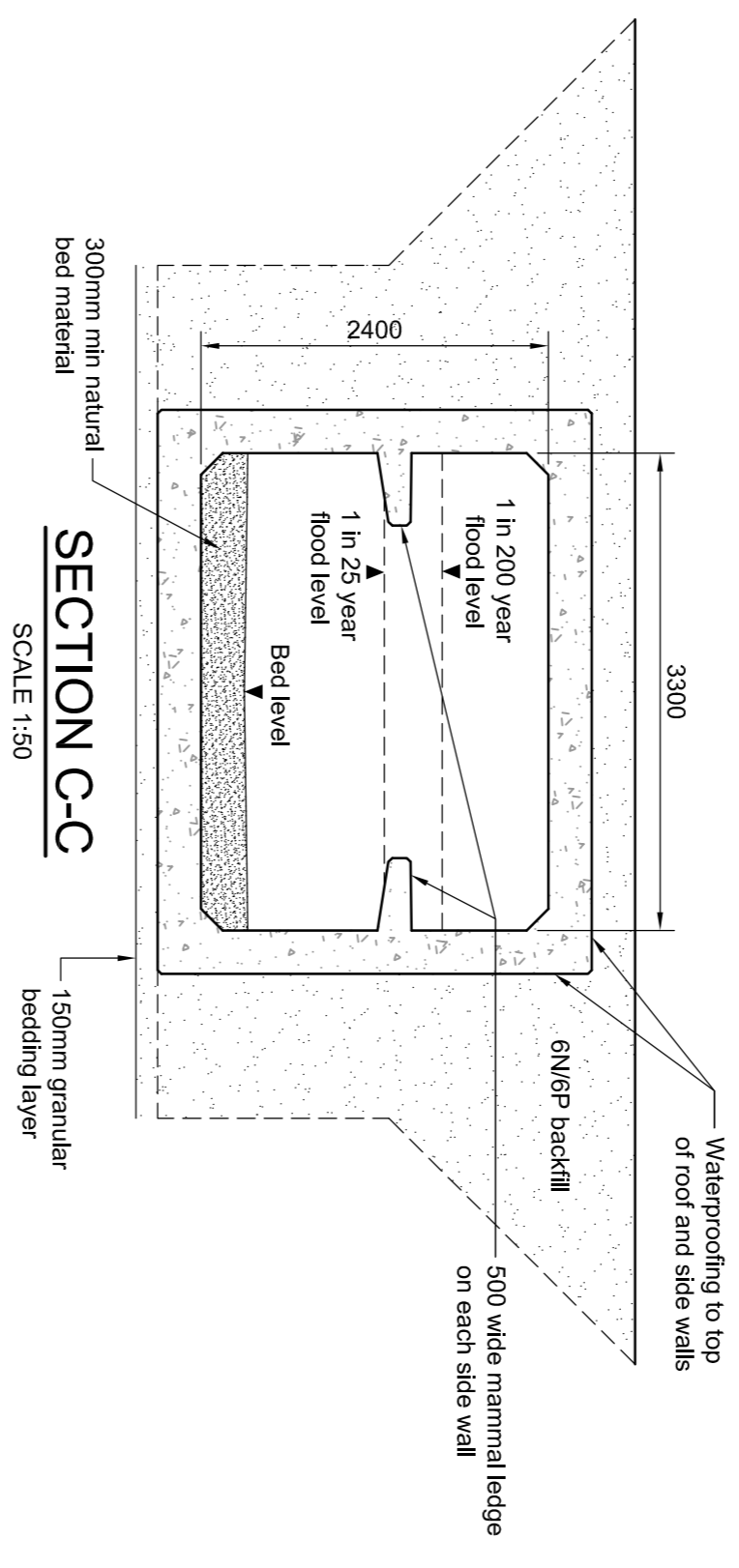

SECTION C-C
 SCALE 1:50

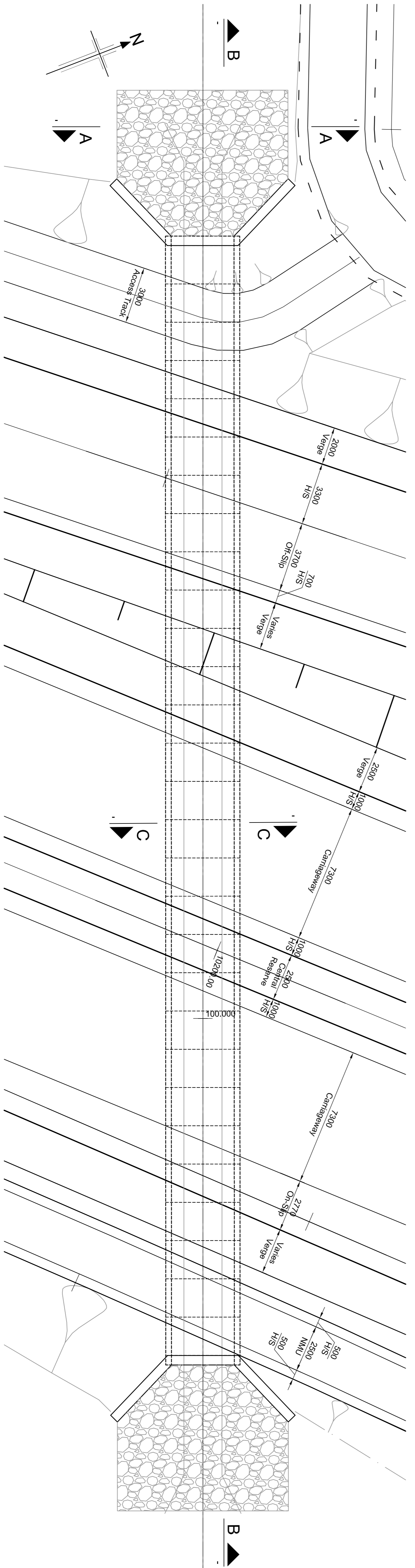

PLAN
 SCALE 1:125

- NOTES:**
1. All dimensions in millimetres unless noted otherwise.
 2. All changes are in metres unless otherwise noted.
 3. Do not scale from this drawing.
 4. All exposed aisles to have 25x25 chamfer unless noted otherwise.
 5. Bedding requirements in accordance with BS EN 14644 or approved equivalent.
 6. All details shown on this drawing are indicative only and subject to change at detail design stage.

Rev	Rev. Date	Purpose of revision	Drawn	Checked	Rev'd	Approved

Client: **JACOBS**
 35 Bonhill St, Glasgow, G2 7HX
 Tel: +44(0)11 4285 3109
 www.jacobs.com

Project: **TRANSPORT SCOTLAND CÒR-DHAIL ALBA**

Drawing title: **DMRB STAGE 3 C13 DALCROSS CULVERT GENERAL ARRANGEMENT**

Drawing status: **FOR INFORMATION**

Scale: **AS SHOWN @ A1**

Jacobs No.: **B2103500**

Bill no.: **DO NOT SCALE**

Drawing number: **B2103500/ST/C13/DR/001**

Rev: **0**

This drawing is not to be used in whole or part other than for the intended purpose and project as defined on this drawing. Refer to the contract for full terms and conditions.

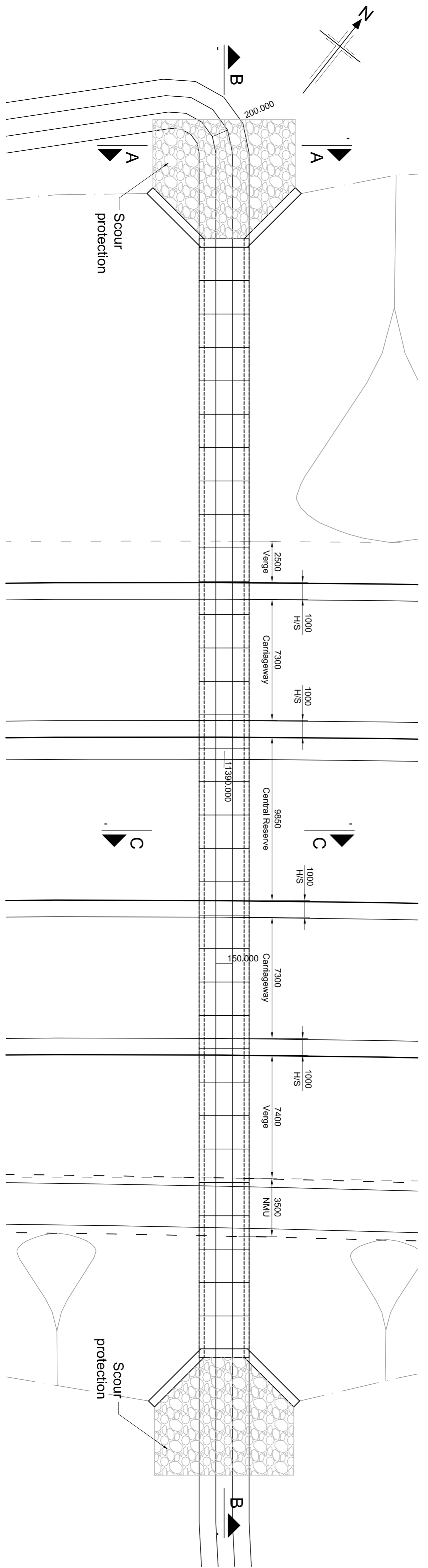
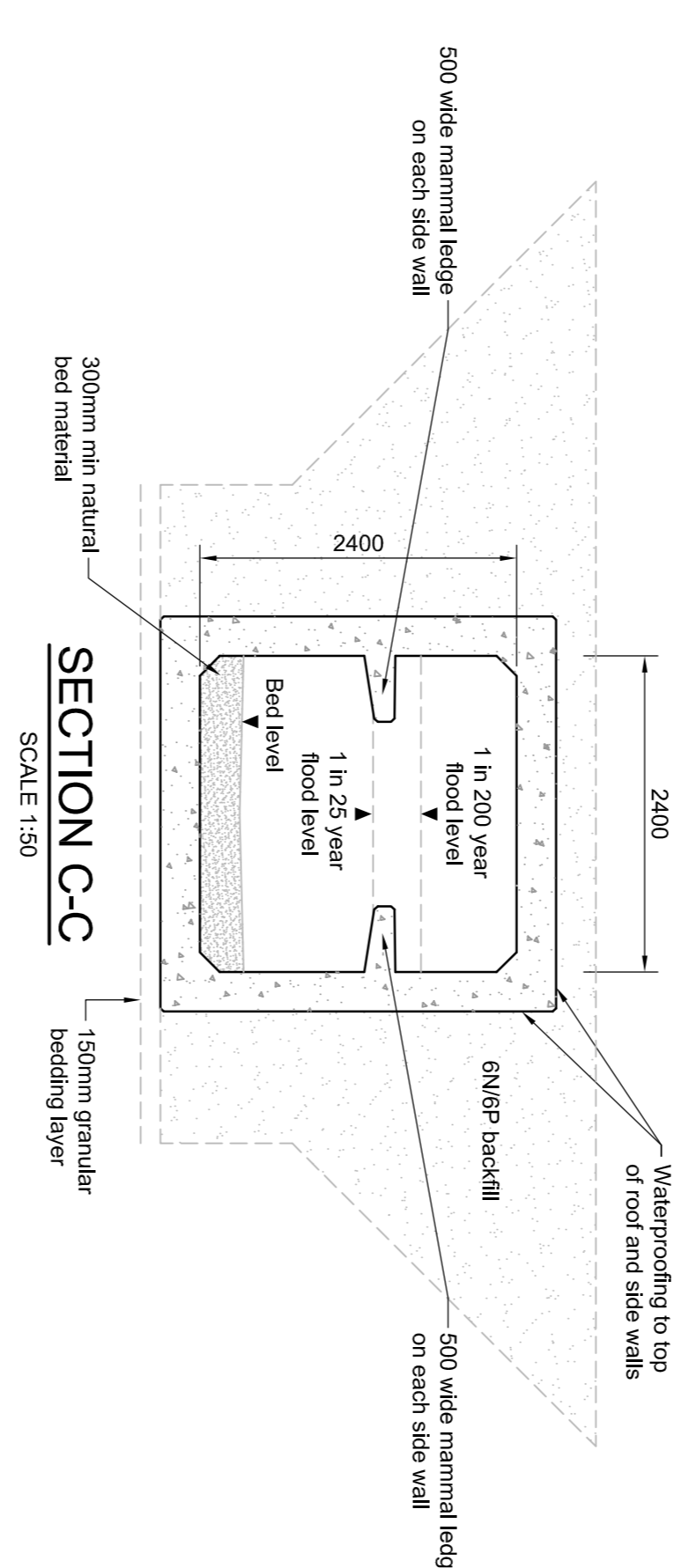
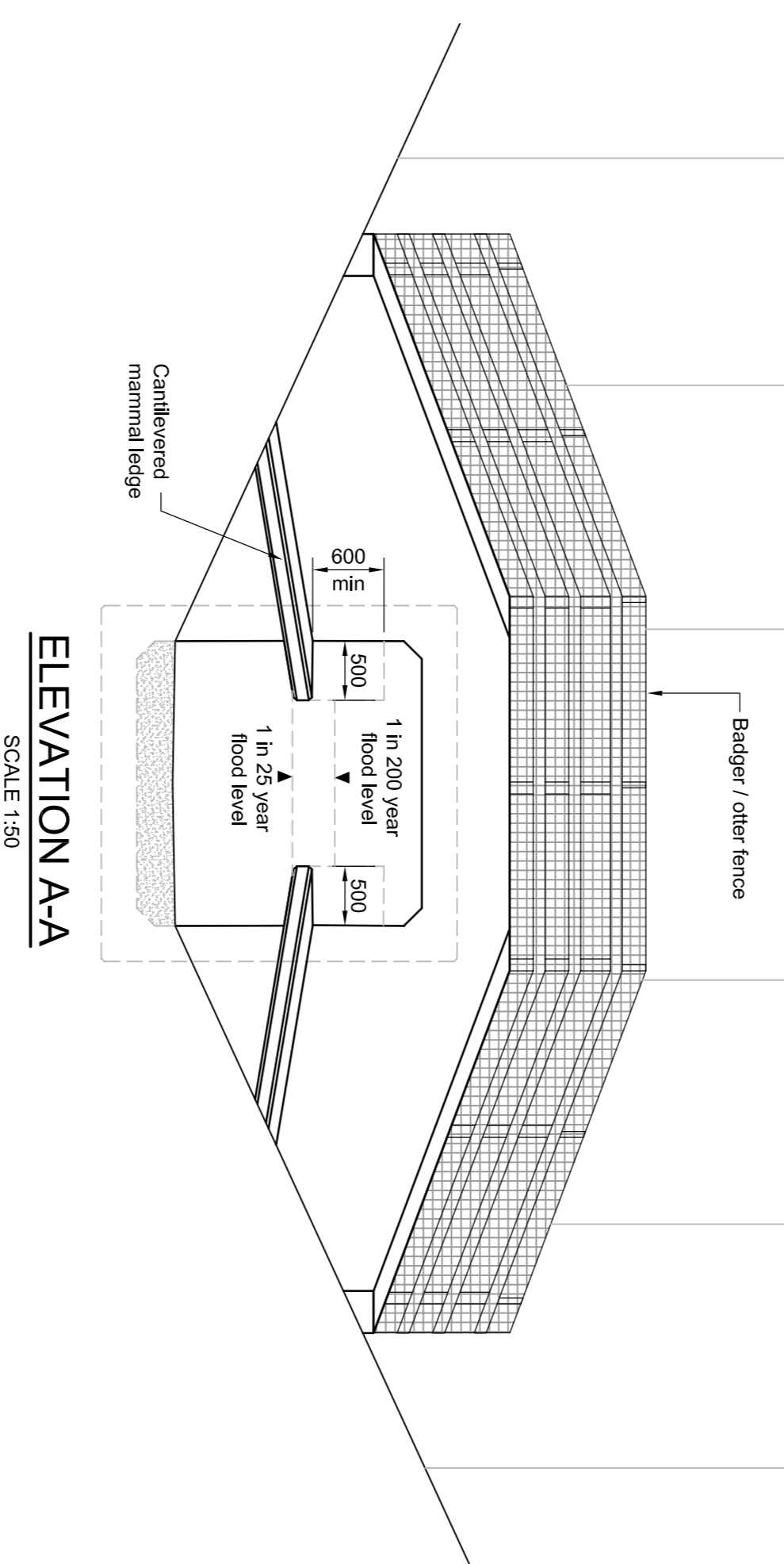
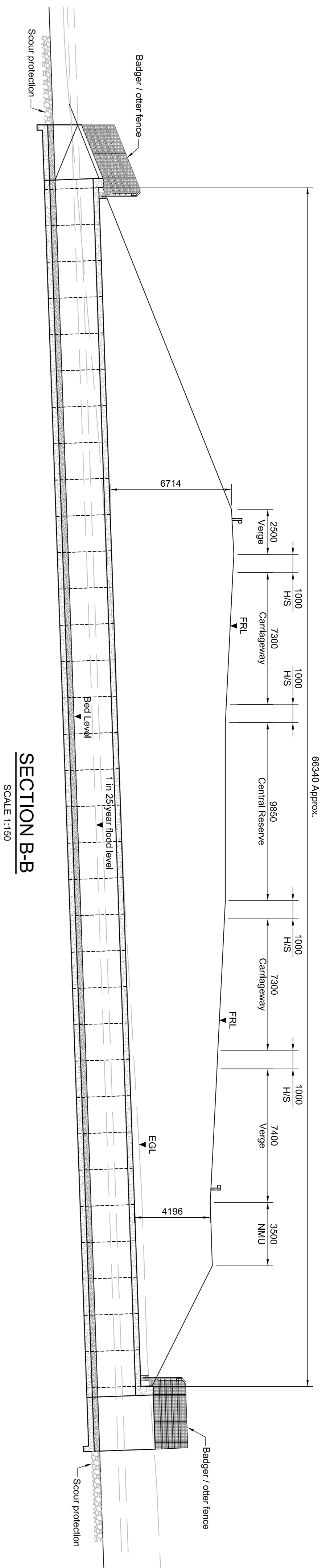

- NOTES:**
1. All dimensions in millimetres unless noted otherwise.
 2. All changes are in metres unless otherwise noted.
 3. Do not scale from this drawing.
 4. All exposed areas to have 25x25 dmfmr unless noted otherwise.
 5. Bedding requirements in accordance with BS EN 14644 or approved equivalent.
 6. All details shown on this drawing are indicative only and subject to change at detail design stage.

Rev	Rev. Date	Purpose of revision	Drawn	Checked	Rev'd	Approved

Client: **JACOBS**
 35 Bonhill St, Glasgow, G2 7HX
 Tel: +44(0)141 206 3100
 www.jacobs.com

Project: **TRANSPORT SCOTLAND CÒMHAIL ALBA**

Drawing title: **DMRB STAGE 3 C22 CULBLAIR CULVERT GENERAL ARRANGEMENT**

Drawing status: **FOR INFORMATION**

Scale: **AS SHOWN @ A1 DO NOT SCALE**

Jacobs No.: **B2103500**

Bill no.: **B2103500/ST/C22/DR/001**

Drawing number: **B2103500/ST/C22/DR/001**

Rev: **0**

This drawing is not to be used in whole or part other than for the intended purpose and project as defined on this drawing. Refer to the contract for full terms and conditions.

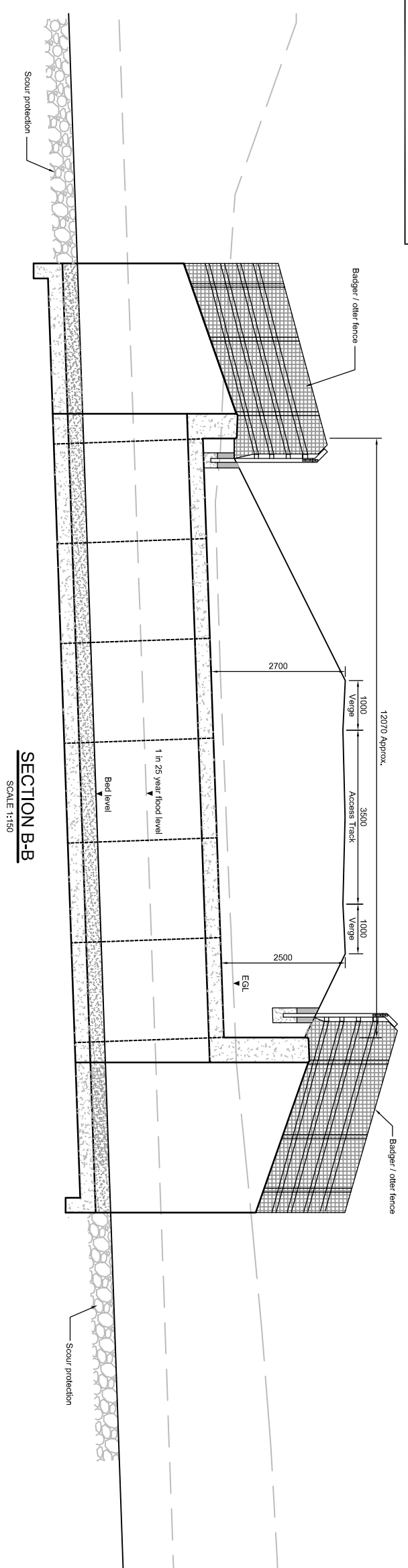

SECTION B-B
 SCALE 1:150

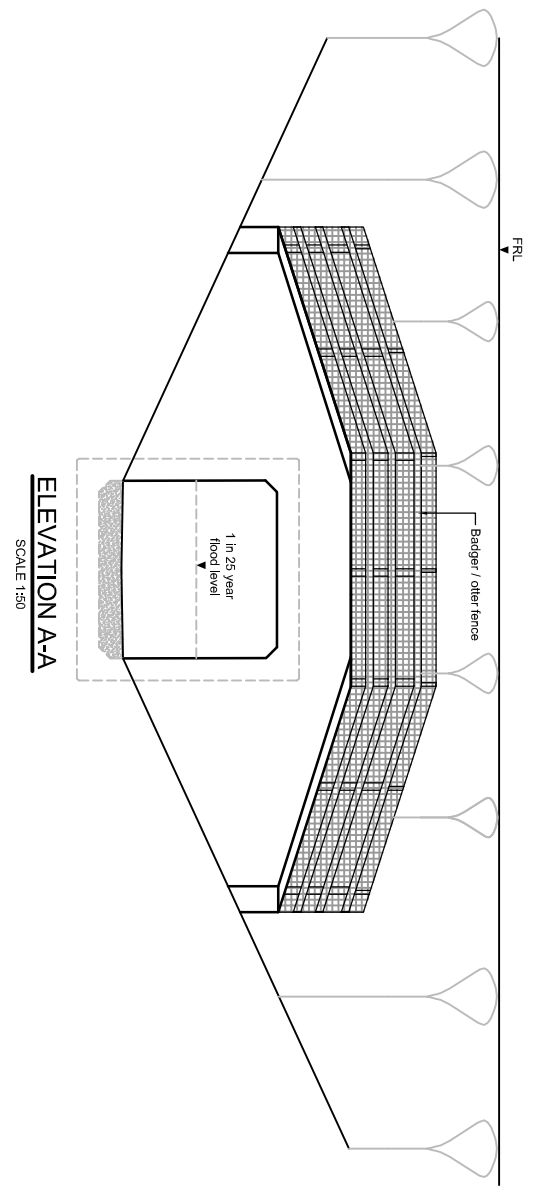

ELEVATION A-A
 SCALE 1:50

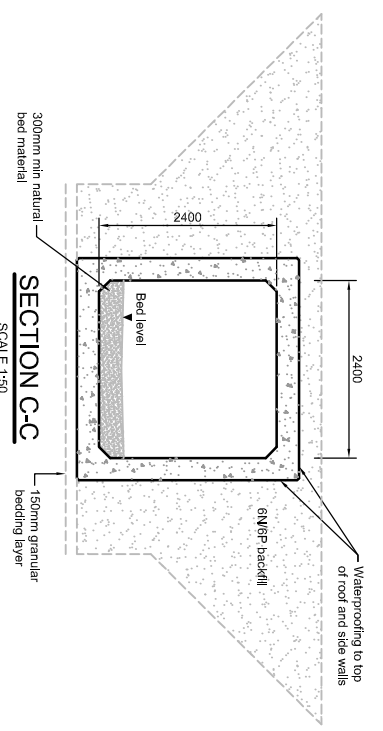

SECTION C-C
 SCALE 1:50

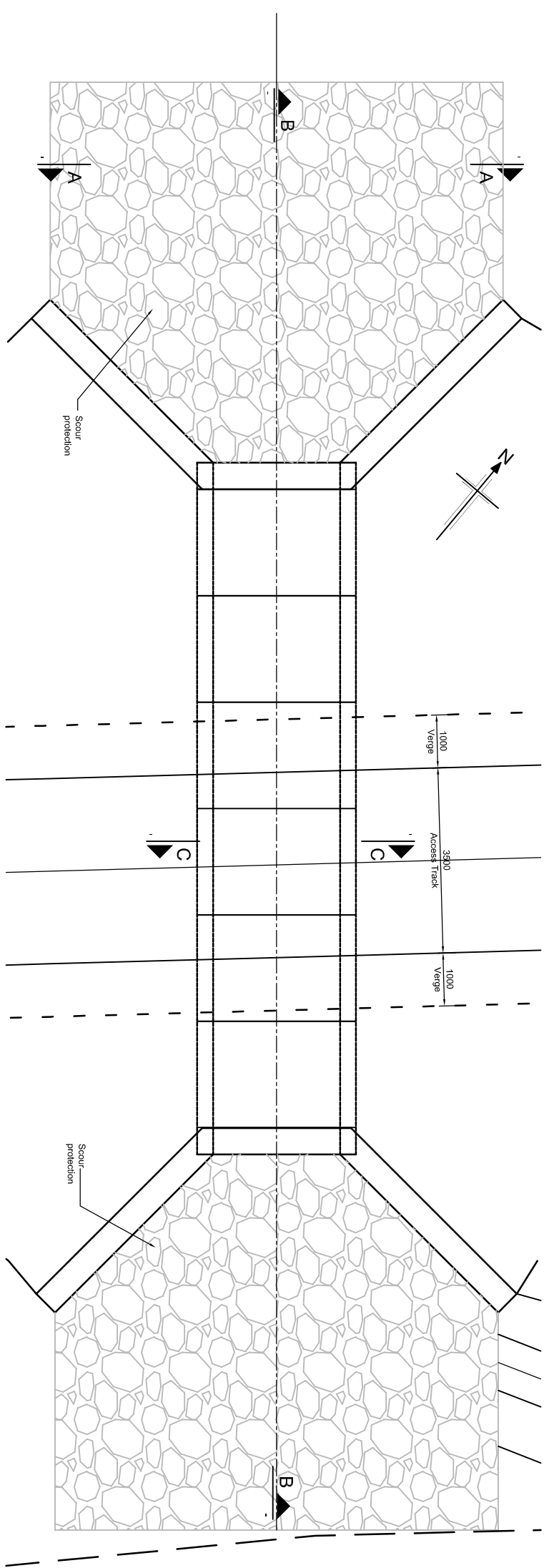

PLAN
 SCALE 1:150

- NOTES:**
1. All dimensions in millimetres unless noted otherwise.
 2. All clearances are in metres unless otherwise noted.
 3. Do not scale from this drawing.
 4. All exposed risers to have 25x25 chamfer unless noted otherwise.
 5. Bedding requirements in accordance with BS EN 14984 or approved equivalent.
 6. All details shown on this drawing are indicative only and subject to change at detail design stage.

Rev	Date	Purpose of revision	Drawn	Checked	Rev'd	App'd



JACOBS
 14-144010147 243 3000 | Fax: +44(0)1473 226 3109
 www.jacobs.com



Project
**DMRB STAGE 3
 C31 CULBLAIR CULVERT NO. 2
 GENERAL ARRANGEMENT**

FOR INFORMATION

Drawing status	Scale	Jacobs No.	BM No.
AS SHOWN @ A1	DO NOT SCALE	B2103500	B2103500

Drawing number	Rev
B2103500/ST/C31/DR/001	0

This drawing is not to be used in whole or part other than for the intended purpose and project as defined on this drawing. Refer to the contract for full terms and conditions.

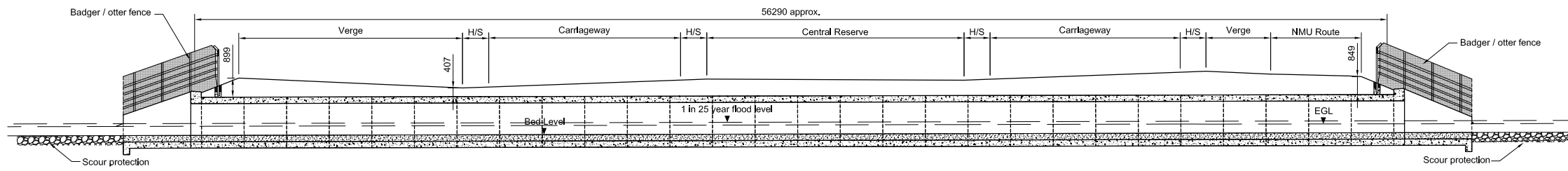

SECTION B-B
 SCALE 1:125

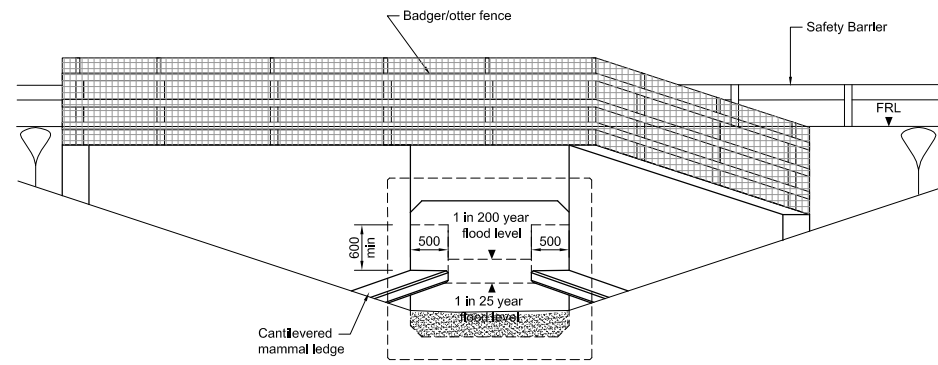

ELEVATION A-A
 SCALE 1:50

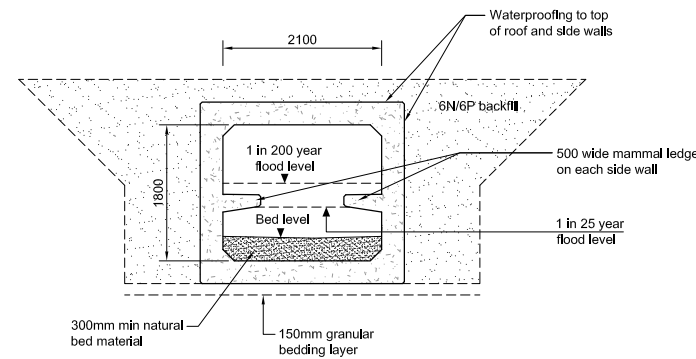

SECTION C-C
 SCALE 1:50

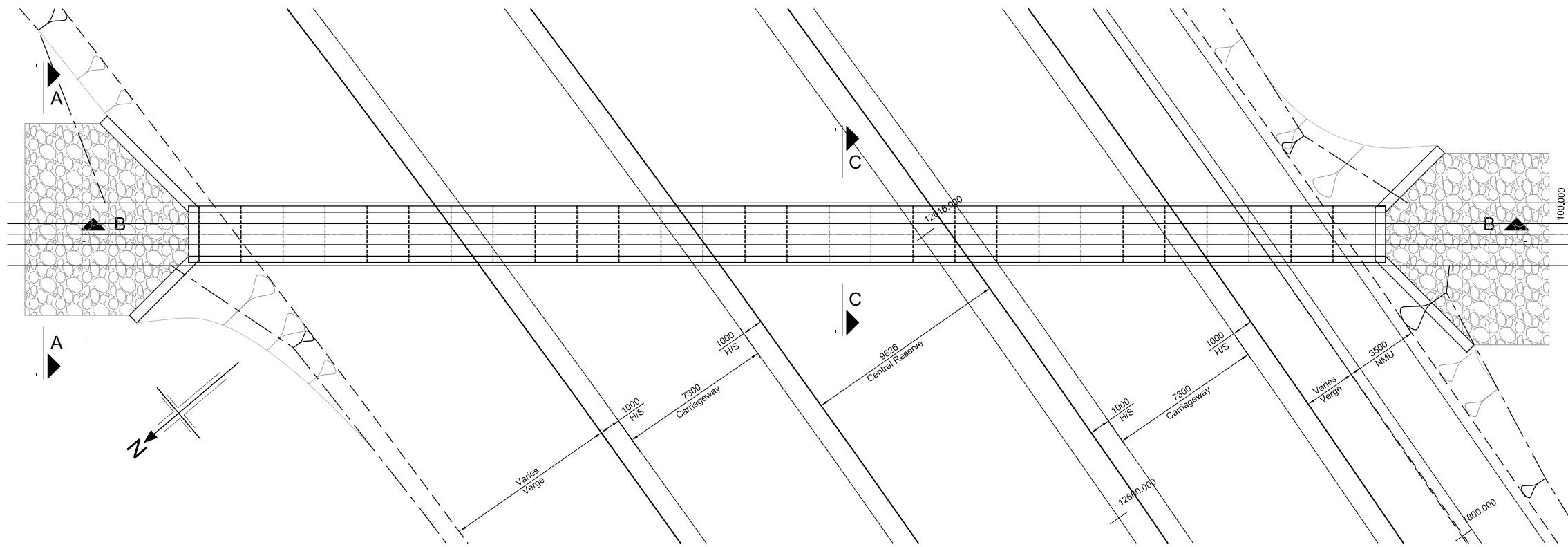

PLAN
 SCALE 1:125

- NOTES:**
- All dimensions in millimetres unless noted otherwise.
 - All chainages are in metres unless otherwise noted.
 - Do not scale from this drawing.
 - All exposed arises to have 25x25 chamfer unless noted otherwise.
 - Bedding requirements in accordance with BS EN 14844 or approved equivalent.
 - All details shown on this drawing are indicative only and subject to change at detail design stage.

Rev	Rev. Date	Purpose of revision	Drawn	Checked	Rev'd	Appr'd
 95 Bothwell St, Glasgow, G2 7HX Tel: +44(0)141 243 8000 Fax: +44(0)141 226 3109 www.jacobs.com						
Client						
Project						
Drawing title						
DMRB STAGE 3 C15 DRUMINE DRAIN CULVERT NO. 1 GENERAL ARRANGEMENT						
Drawing status						
FOR INFORMATION						
Scale		AS SHOWN @ A1	DO NOT SCALE			
Jacobs No.		B2103500				
BIM no.						
Drawing number						Rev
B2103500/ST/C15/DR/001						1
This drawing is not to be used in whole or part other than for the intended purpose and project as defined on this drawing. Refer to the contract for full terms and conditions.						

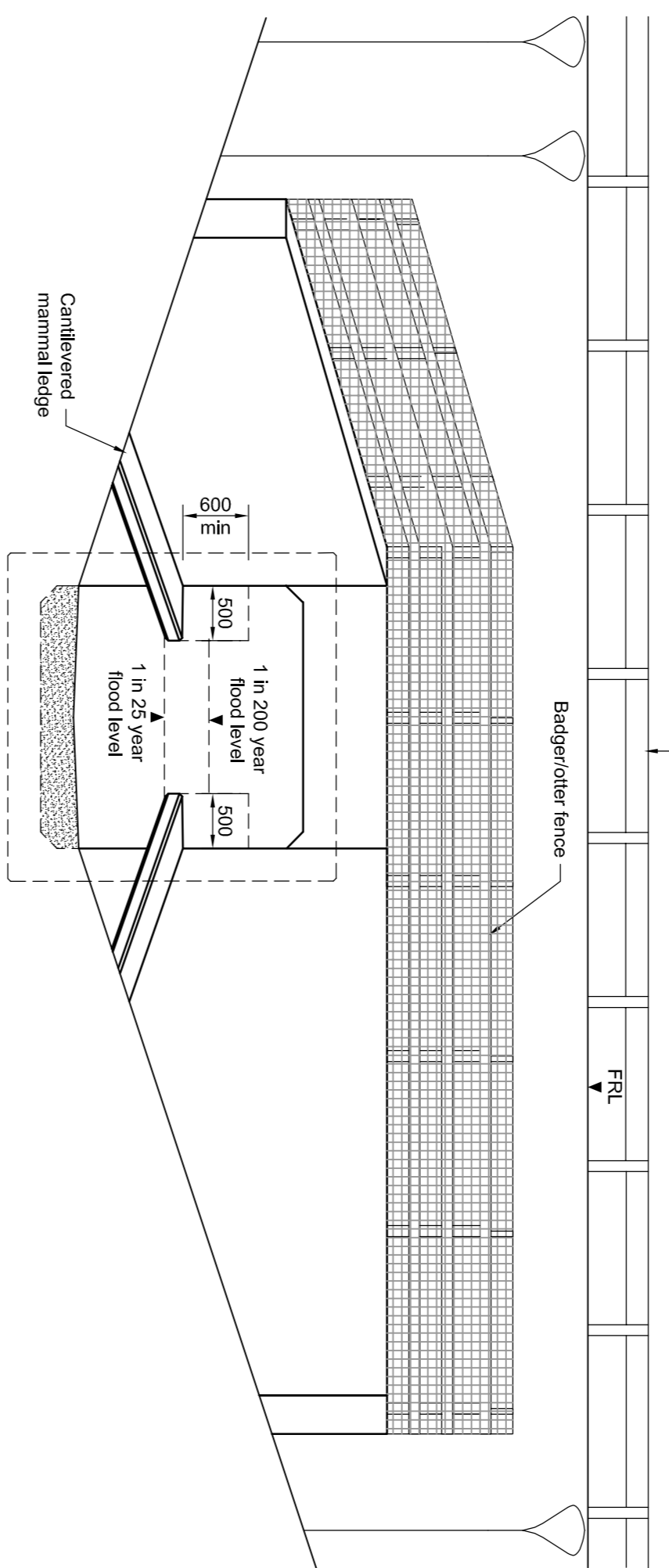
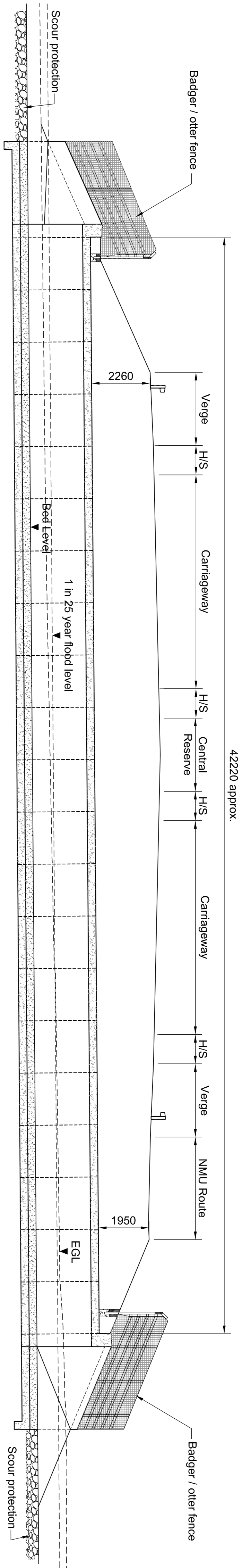

ELEVATION A-A
SCALE 1:50

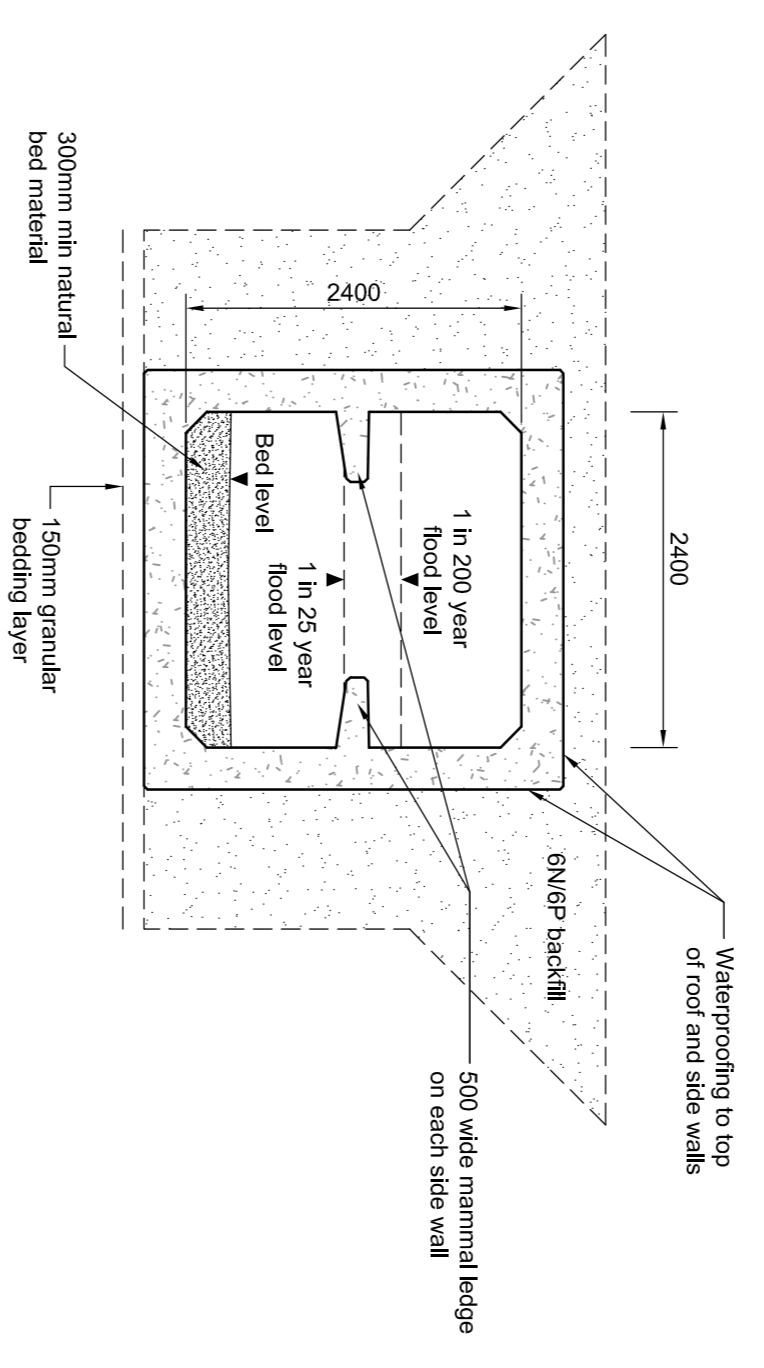

SECTION C-C
SCALE 1:50

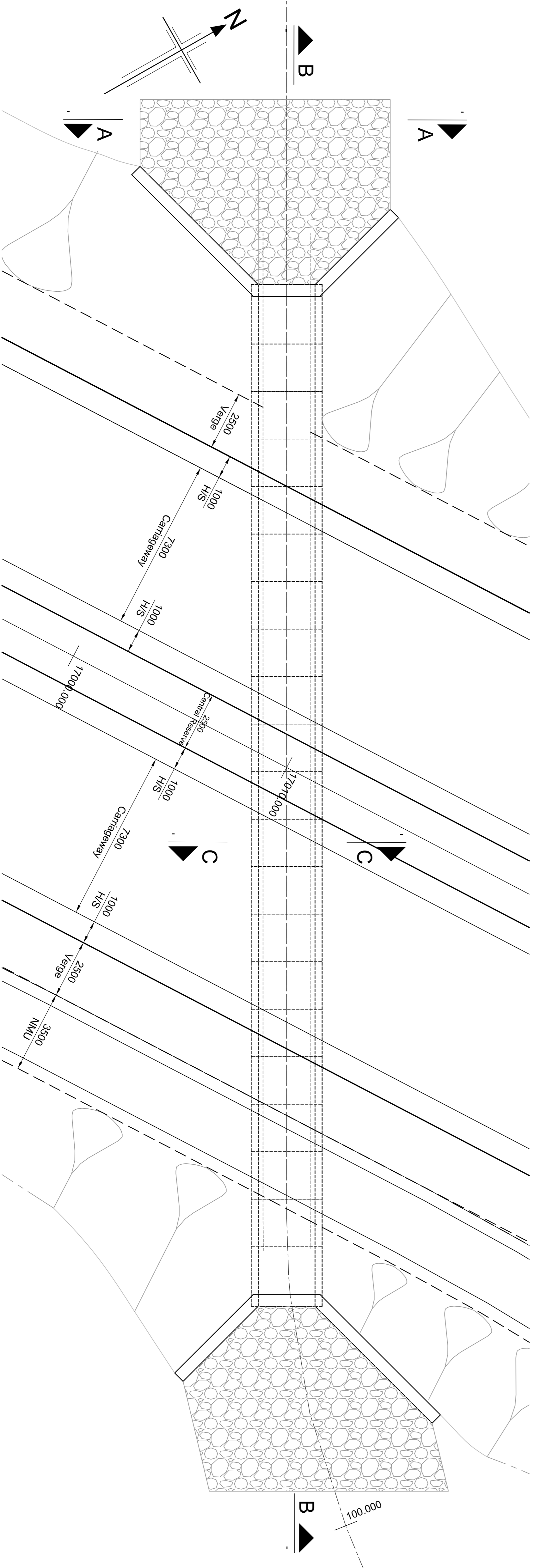

PLAN
SCALE 1:125

- NOTES:**
1. All dimensions in millimetres unless noted otherwise.
 2. All changes are in metres unless otherwise noted.
 3. Do not scale from this drawing.
 4. All exposed areas to have 25x25 dmfmr unless noted otherwise.
 5. Bedding requirements in accordance with BS EN 14644 or approved equivalent.
 6. All details shown on this drawing are indicative only and subject to change at detail design stage.

Rev	Rev. Date	Purpose of revision	Drawn	Checked	Rev'd	Approved

Client: **JACOBS**
 35 Bonhill St, Glasgow, G2 7JX
 Tel: +44(0)141 209 3100
 www.jacobs.com

Project: **TRANSPORT SCOTLAND CÒRHDHAL ALBA**

Drawing title: **DMRB STAGE 3 C17 BLACKCASTLE CULVERT GENERAL ARRANGEMENT**

Drawing status: **FOR INFORMATION**

Scale: **AS SHOWN @ A1 DO NOT SCALE**

Jacobs No.: **B2103500**

BIM no.: **B2103500/ST/C17/DR/001**

Drawing number: **0**

This drawing is not to be used in whole or part other than for the intended purpose and project as defined on this drawing. Refer to the contract for full terms and conditions.

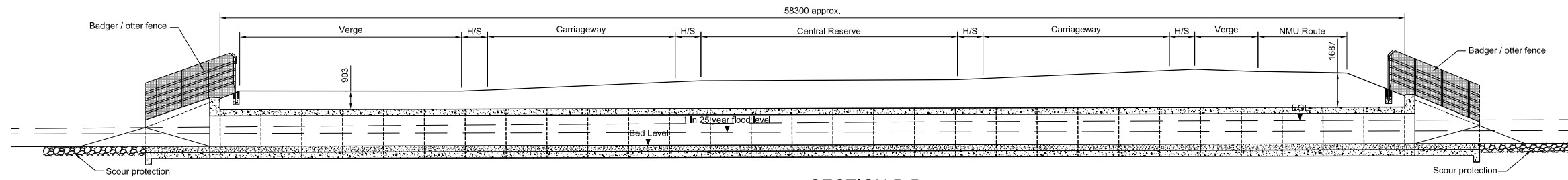

SECTION B-B
 SCALE 1:125

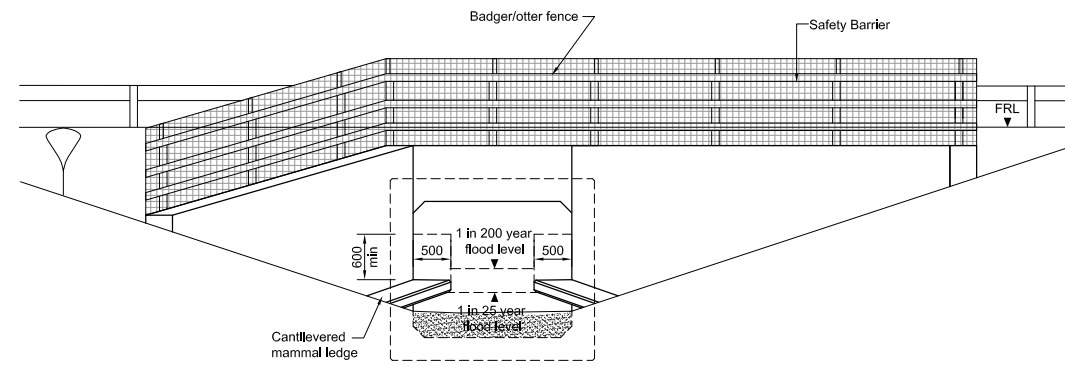

ELEVATION A-A
 SCALE 1:50

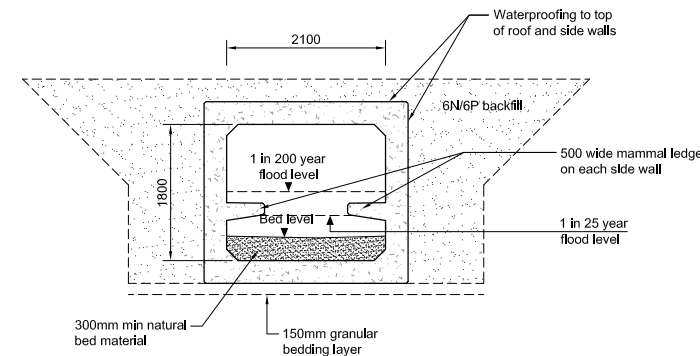

SECTION C-C
 SCALE 1:50

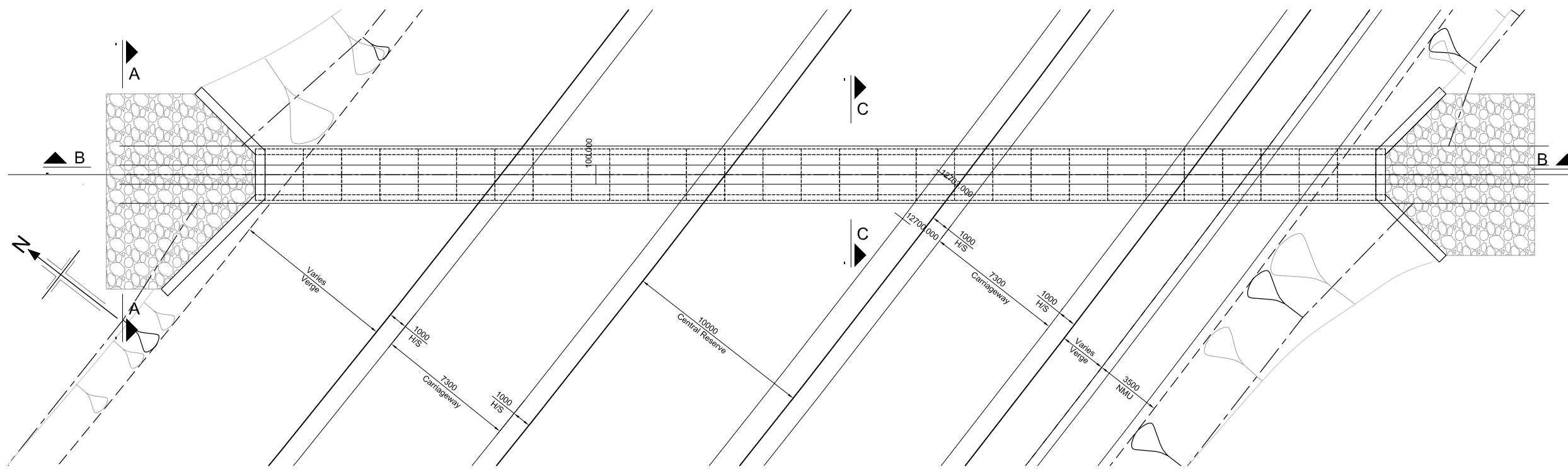

PLAN
 SCALE 1:125

- NOTES:**
- All dimensions in millimetres unless noted otherwise.
 - All chainages are in metres unless otherwise noted.
 - Do not scale from this drawing.
 - All exposed arises to have 25x25 chamfer unless noted otherwise.
 - Bedding requirements in accordance with BS EN 14844 or approved equivalent.
 - All details shown on this drawing are indicative only and subject to change at detail design stage.

Rev	Rev. Date	Purpose of revision	Drawn	Checked	Rev'd	Appr'd
 95 Bothwell St, Glasgow, G2 7HX Tel: +44(0)141 243 8000 Fax: +44(0)141 226 3109 www.jacobs.com						
Client						
Project						
Drawing title						
DMRB STAGE 3 C16 DRUMINE DRAIN CULVERT NO. 2 GENERAL ARRANGEMENT						
Drawing status						
FOR INFORMATION						
Scale		AS SHOWN @ A1	DO NOT SCALE			
Jacobs No.		B2103500				
BIM no.						
Drawing number						Rev
B2103500/ST/C16/DR/001						1
This drawing is not to be used in whole or part other than for the intended purpose and project as defined on this drawing. Refer to the contract for full terms and conditions.						

File: P:\Data\B2103500 - A96 Inverness to Nairn Inc\Nairn bypass\Structures\CAD\Culverts\C16 Drumine Drain Culvert No 2 SWF 18-2\B2103500-ST-C16-DR-001 Rev 1.dwg Date: Jun 06, 2016 - 11:50am Plotted by: edamb

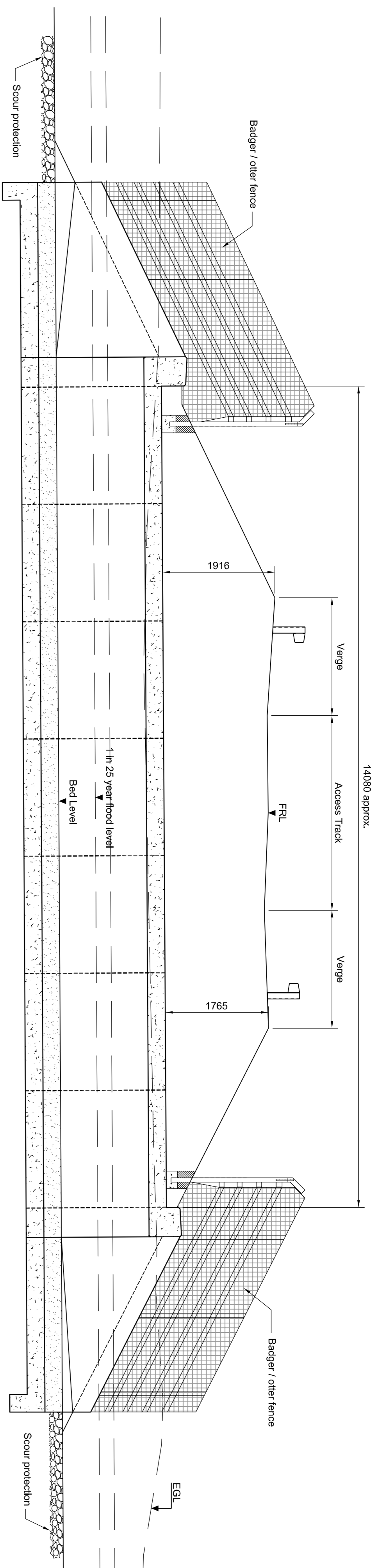

SECTION B-B
 SCALE 1:50

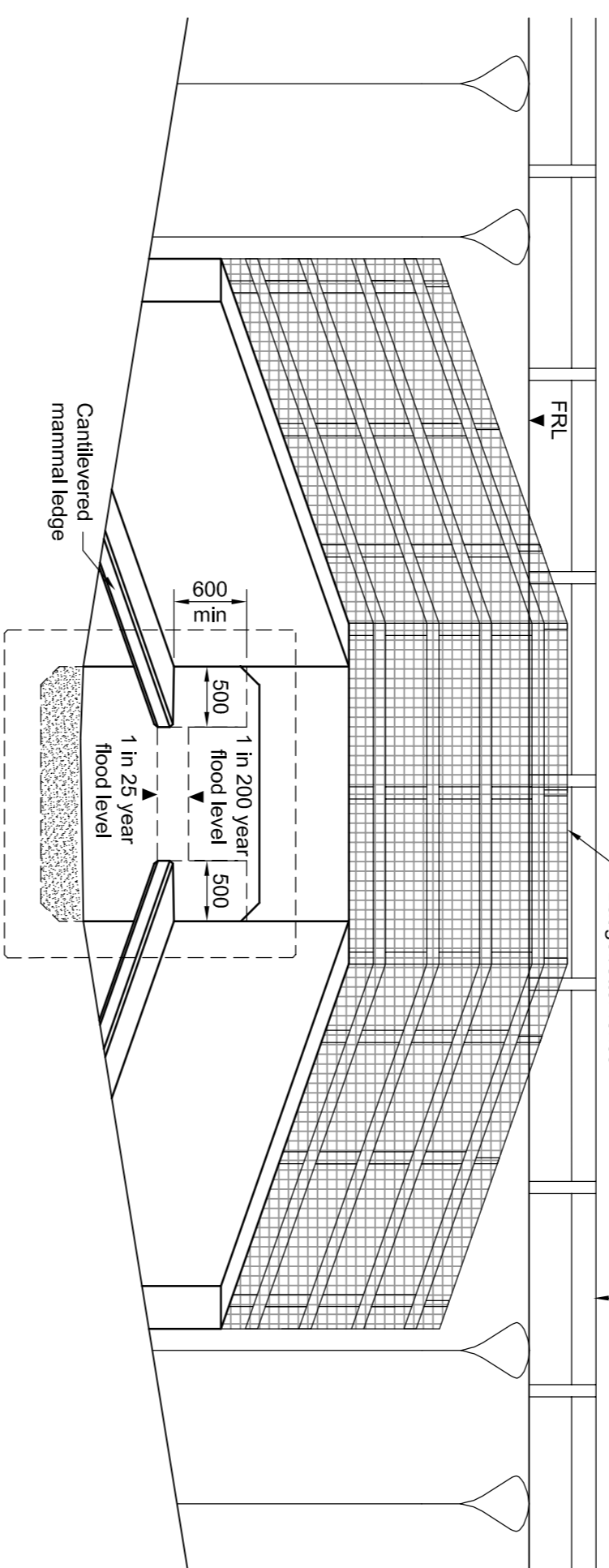

ELEVATION AA
 SCALE 1:50

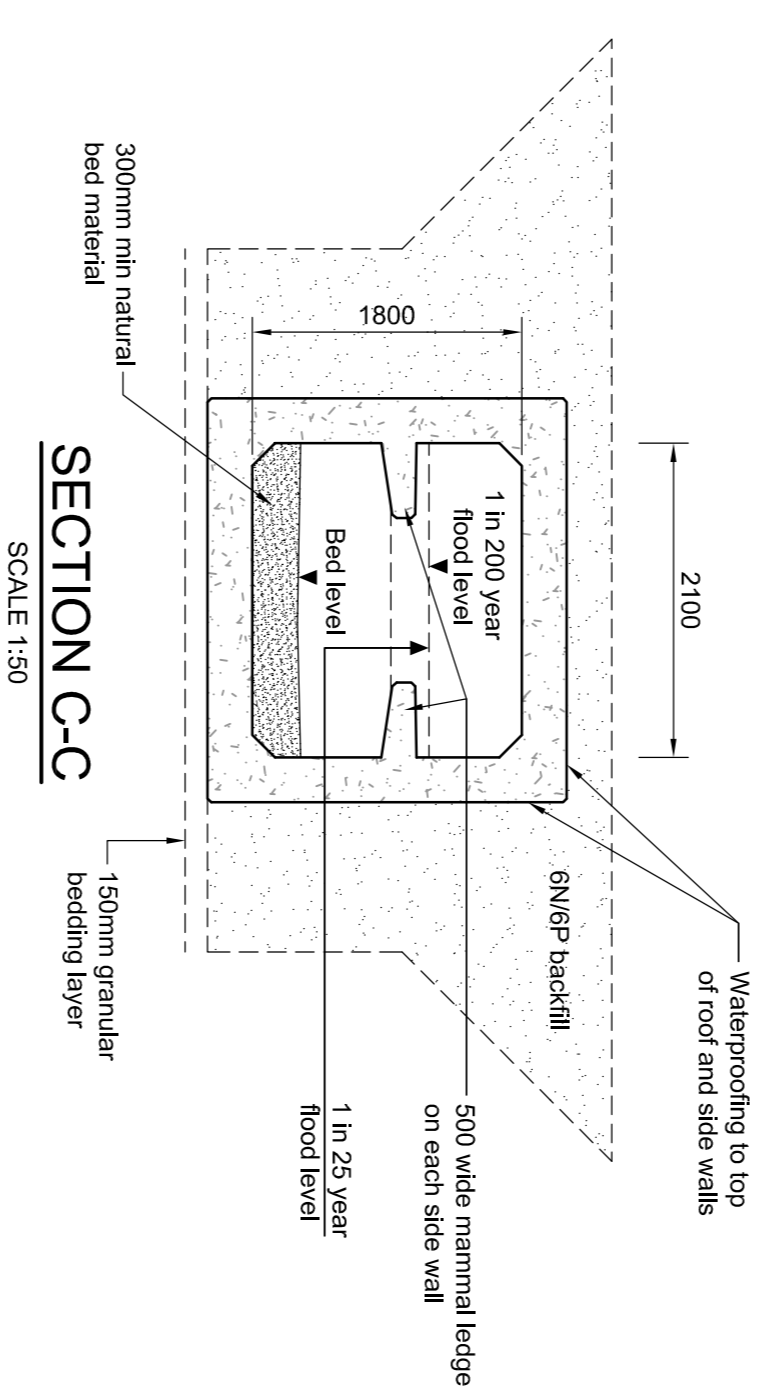

SECTION C-C
 SCALE 1:50

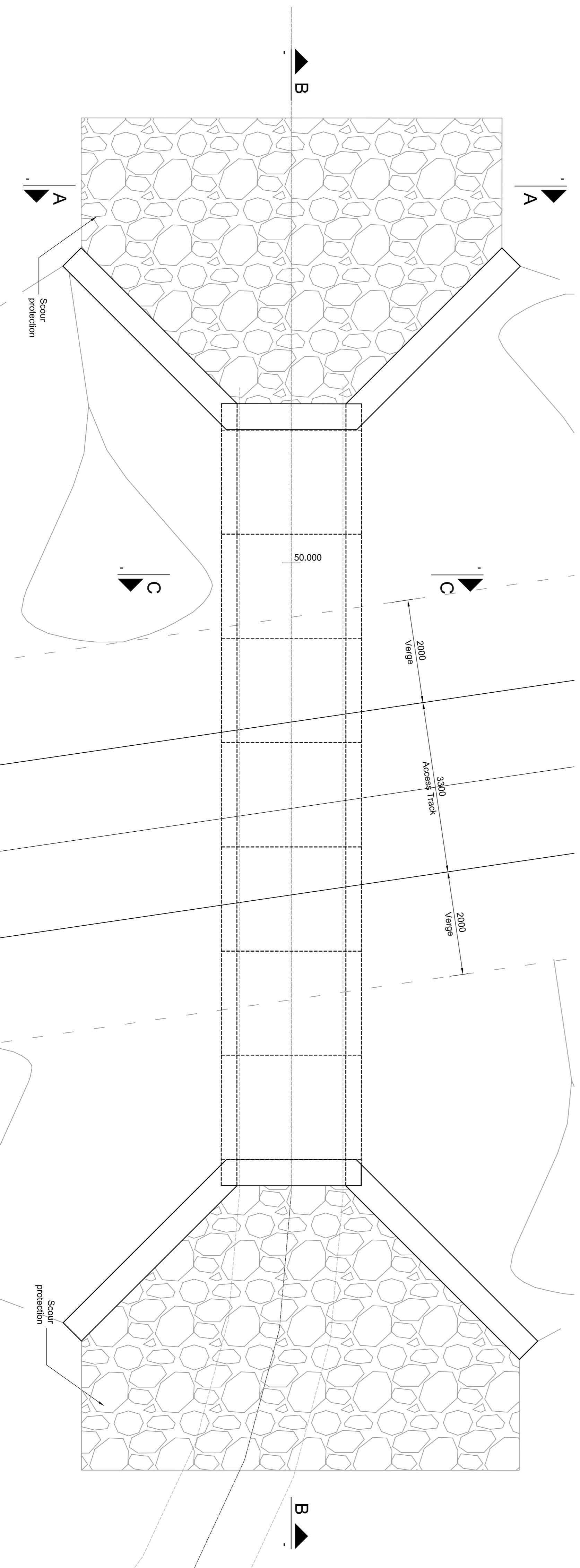

PLAN
 SCALE 1:50

- NOTES:**
1. All dimensions in millimetres unless noted otherwise.
 2. All changes are in metres unless otherwise noted.
 3. Do not scale from this drawing.
 4. All exposed areas to have 25x25 damper unless noted otherwise.
 5. Bedding requirements in accordance with BS EN 14694 or approved equivalent.
 6. All details shown on this drawing are indicative only and subject to change at detail design stage.

Rev	Rev. Date	Purpose of revision	Drawn	Checked	Rev'd	Approved

Client: **JACOBS**
 35 Bonhill St, Glasgow, G2 7HX
 Tel: +44(0)141 228 3100
 www.jacobs.com

Project: **TRANSPORT SCOTLAND CÒR-DHÀIL ALBA**

Drawing title: **DMRB STAGE 3 C23 CRANFORD CULVERT GENERAL ARRANGEMENT**

Drawing status: **FOR INFORMATION**

Scale: **AS SHOWN @ A1 DO NOT SCALE**

Jacobs No.: **B2103500**

Bill no.: **B2103500/ST/C23/DR/001**

Drawing number: **0**

This drawing is not to be used in whole or part other than for the intended purpose and project as defined on this drawing. Refer to the contract for full terms and conditions.

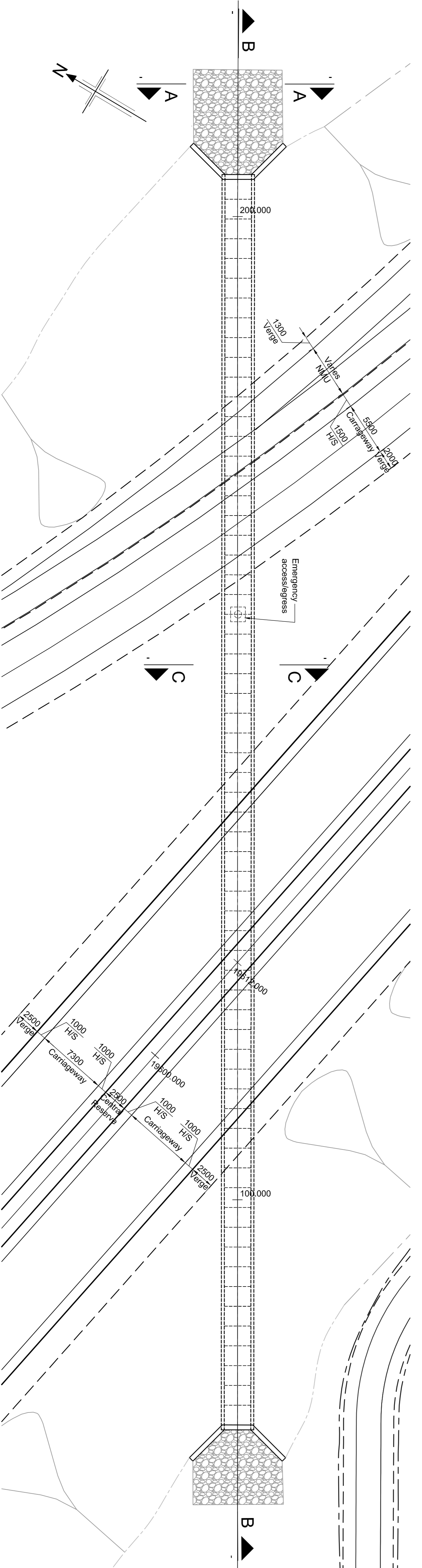
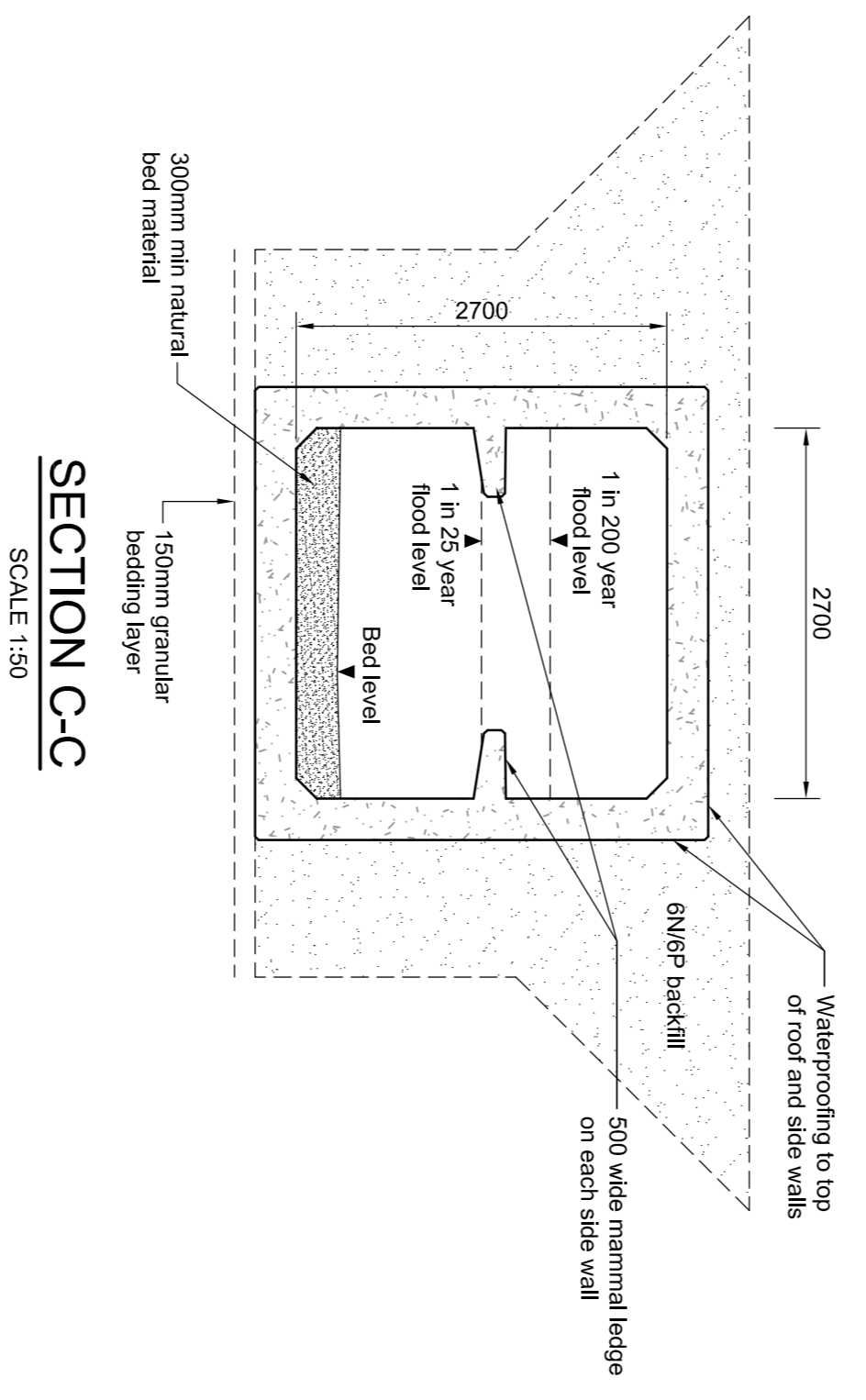
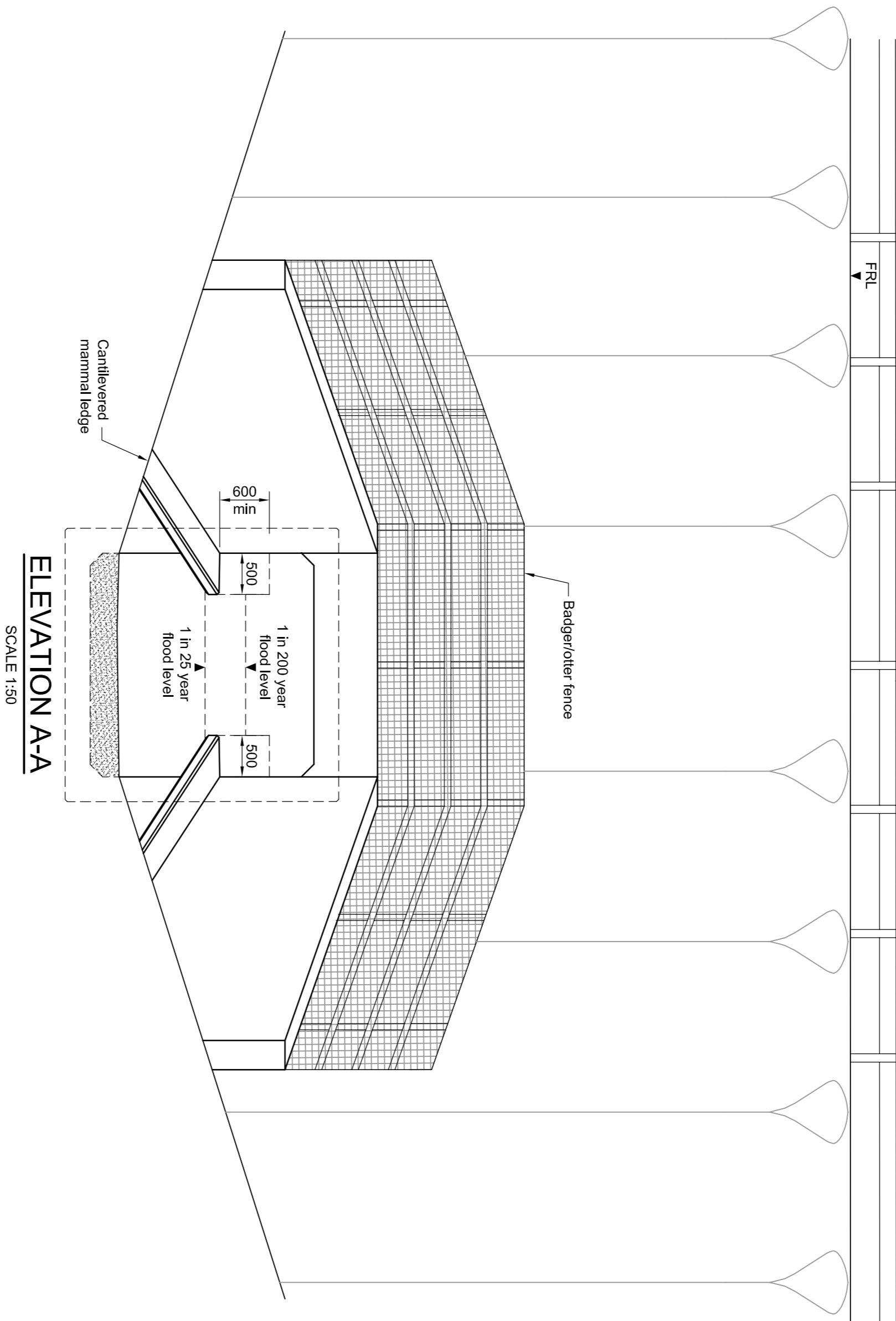
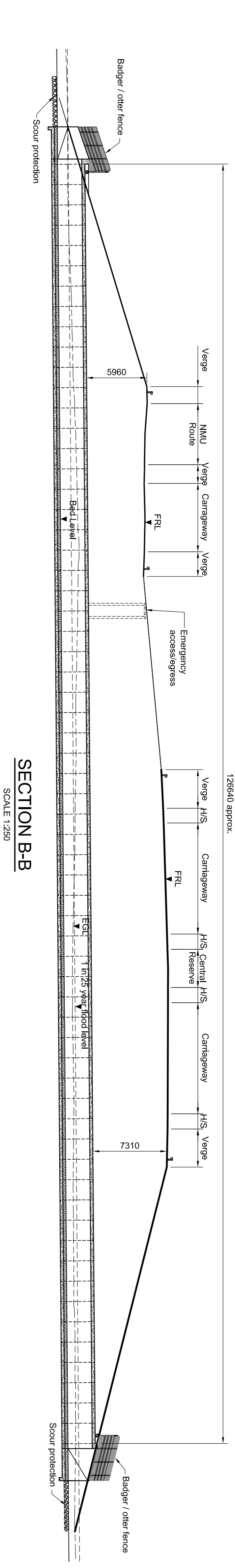

- NOTES:**
1. All dimensions in millimetres unless noted otherwise.
 2. All changes are in metres unless otherwise noted.
 3. Do not scale from this drawing.
 4. All exposed assets to have 25x25 chamfer unless noted otherwise.
 5. Bedding requirements in accordance with BS EN 14694 or approved equivalent.
 6. All details shown on this drawing are indicative only and subject to change at detail design stage.

Rev	Rev. Date	Purpose of revision	Drawn	Checked	Rev'd	Approved

JACOBS
 35 Bonhill St, Glasgow, G2 7JX
 Tel: +44(0)141 206 3100
 www.jacobs.com

TRANSPORT SCOTLAND
 CO-ORDINATED

A96
 DUALING
 INVERNESS TO NAIRN
 (incl. Nairn Bypass)

Project
DMRB STAGE 3
C18 ALTON BURN CULVERT
GENERAL ARRANGEMENT

Drawing title
FOR INFORMATION
 Scale: **AS SHOWN @ A1** DO NOT SCALE
 Jacobs No: **B2103500**
 Bill no:
 Drawing number: **B2103500/ST/C18/DR/001**
 Rev: **0**

This drawing is not to be used in whole or part other than for the intended purpose and project as defined on this drawing. Refer to the contract for full terms and conditions.

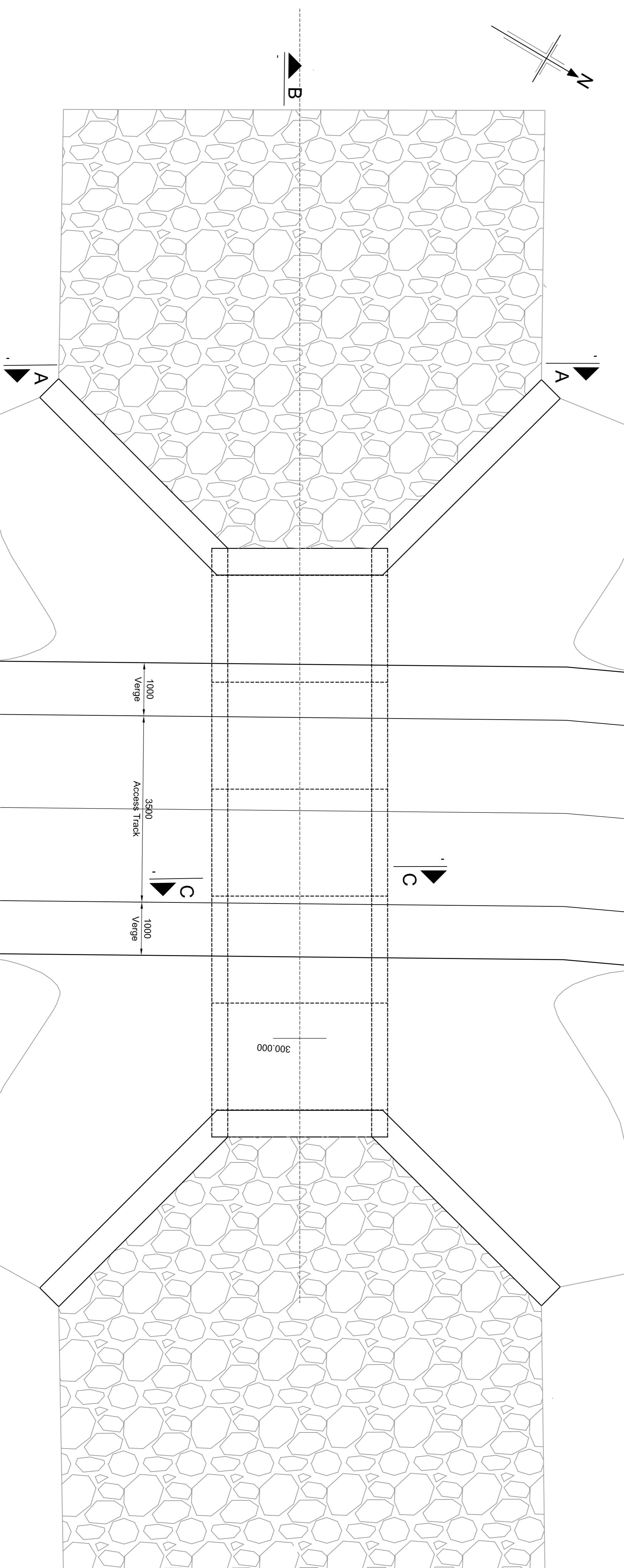
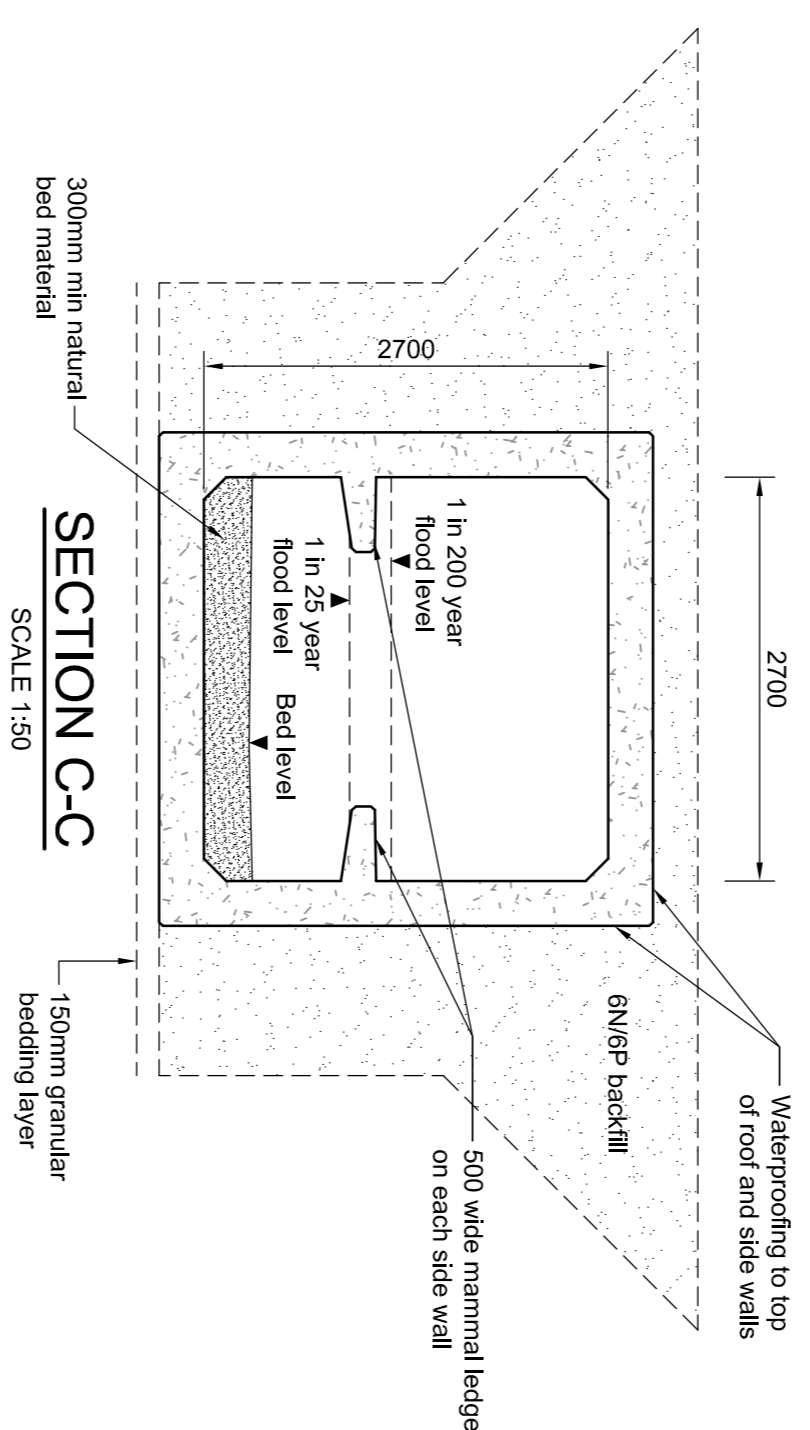
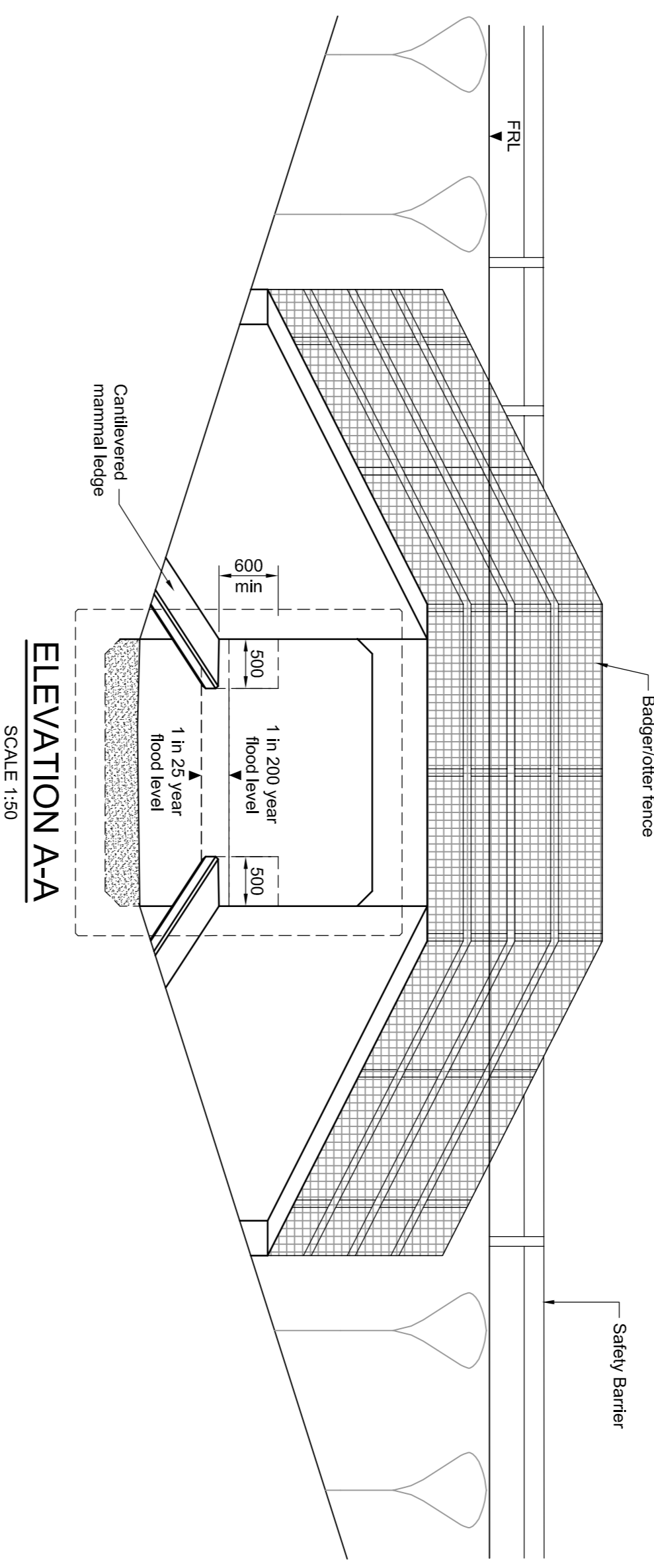
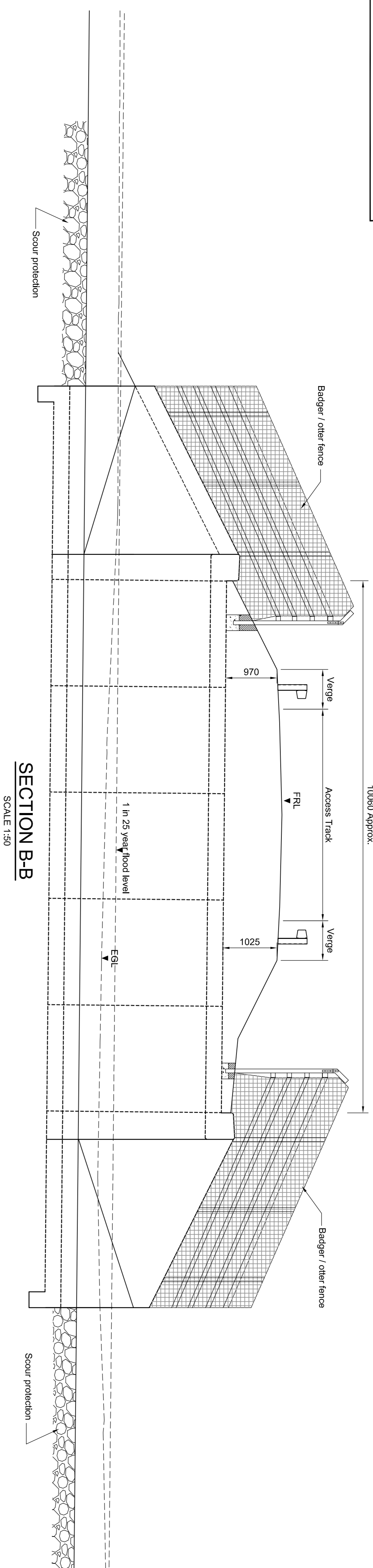

NOTES:

1. All dimensions in millimetres unless noted otherwise.
2. All changes are in metres unless otherwise noted.
3. Do not scale from this drawing.
4. All exposed assets to have 25x25 chamfer unless noted otherwise.
5. Bedding requirements in accordance with BS EN 14694 or approved equivalent.
6. All details shown on this drawing are indicative only and subject to change at detail design stage.

Rev	Rev. Date	Purpose of revision	Drawn	Checked	Rev'd	Approved

JACOBS
 35 Barnwell St, Glasgow, G2 7HX
 Tel: +44(0)11 730 7100
 www.jacobs.com

TRANSPORT SCOTLAND
 CÒR-DHÀIL ALBA

A96
 DUALLING
 INVERNESS TO NAIRN
 (incl. Nairn Bypass)

Project
 DMRB STAGE 3
 C25 ALTON BURN CULVERT NO. 2
 GENERAL ARRANGEMENT

Drawing title
 FOR INFORMATION

Scale
 AS SHOWN @ A1
 DO NOT SCALE

Drawing number
B2103500/ST/C25/DR/001
 Rev 0

This drawing is not to be used in whole or part other than for the intended purpose and project as defined on this drawing. Refer to the contract for full terms and conditions.

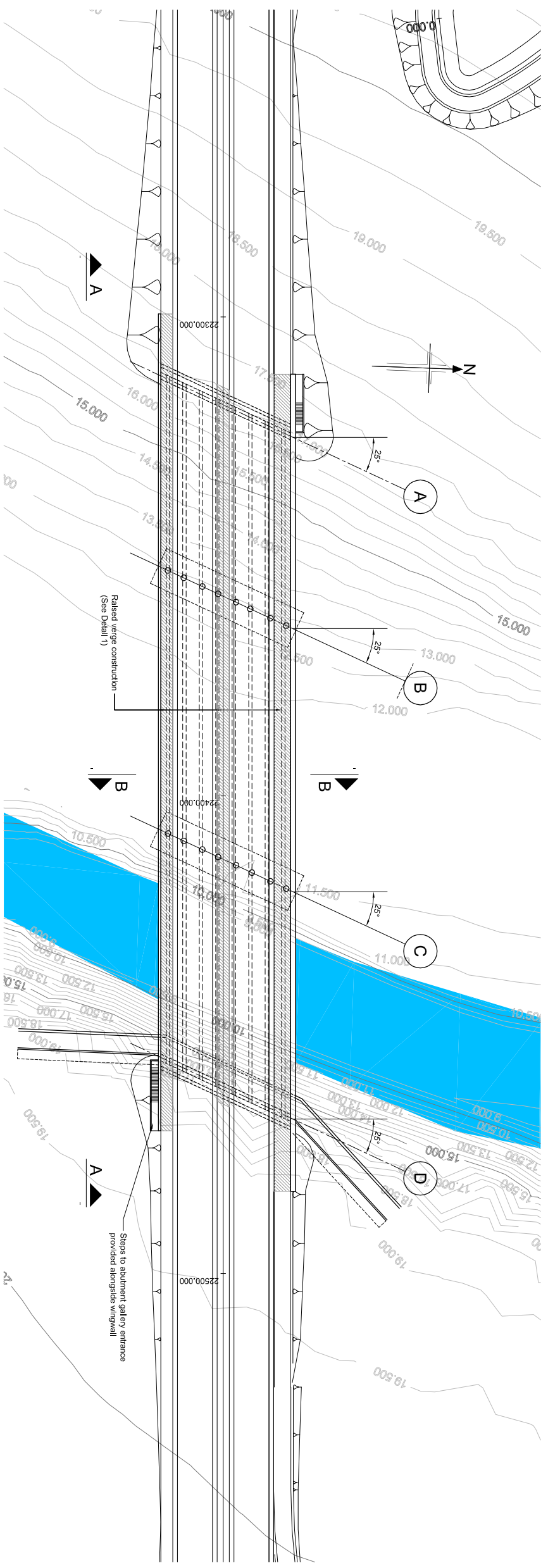
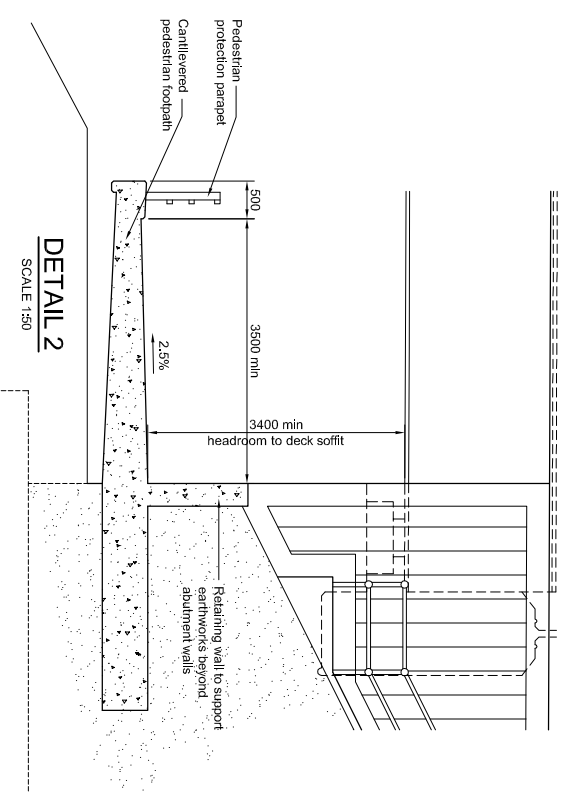
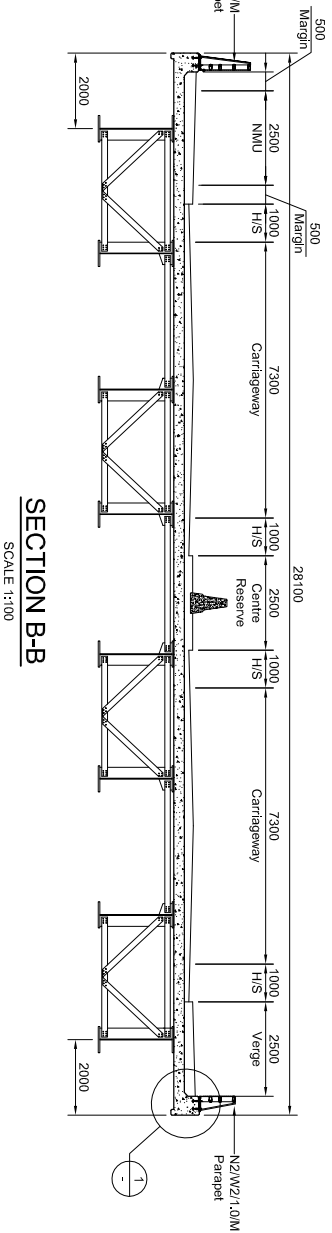
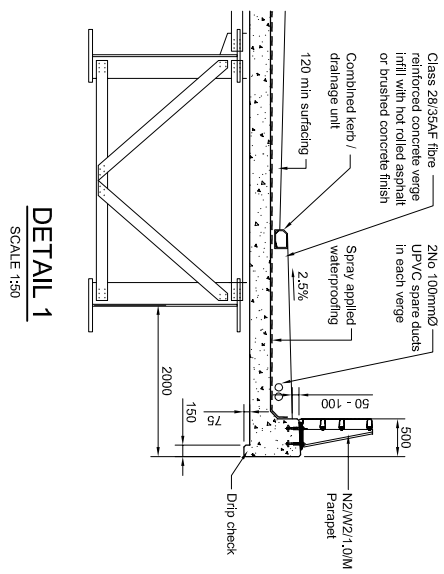
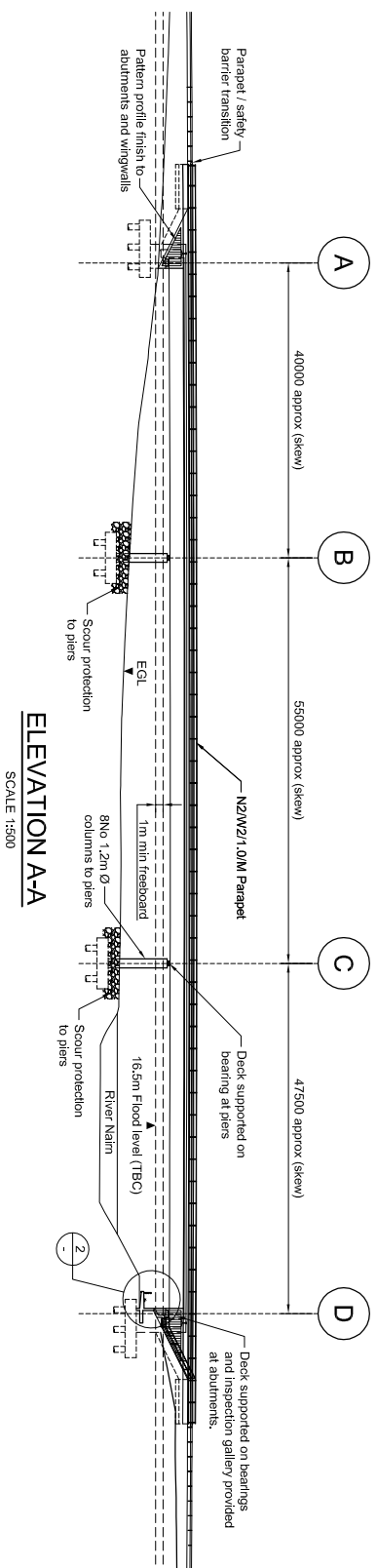

- NOTES:**
1. All dimensions in millimetres unless noted otherwise.
 2. Do not scale from this drawing.
 3. All exposed areas to have 25/25 chamfer unless noted otherwise.
 4. All details shown on this drawing are indicative only and subject to change at detail design stage.

Rev.	Rev. Date	Purpose of revision	Drawn	Checked	Rev'd	Approved
4	12/06/16	For Information	BA			
3	24/06/16	For Information	BA			
2	13/05/16	For Information	BA			
1	08/03/16	For Information	JMKC			

JACOBS
 95 Belford St, Glasgow, G2 7HX
 Tel: +44(0)141 248 6000
 www.jacobs.com

TRANSPORT SCOTLAND
 COMHIDHAL ALBA

AS3
 DUALLING

DMRB STAGE 3
PS14 RIVER NAIRN BRIDGE
GENERAL ARRANGEMENT

FOR INFORMATION
 DO NOT SCALE

Drawing status
 Scale: AS SHOWN @ A1
 Jacobs No: B2103500
 BIM no:
 Drawing number: **B2103500/ST/PS14/DR/001**
 Rev: **4**

This drawing is not to be used in whole or part other than for the intended purpose and project as defined on this drawing. Refer to the contract for full terms and conditions.

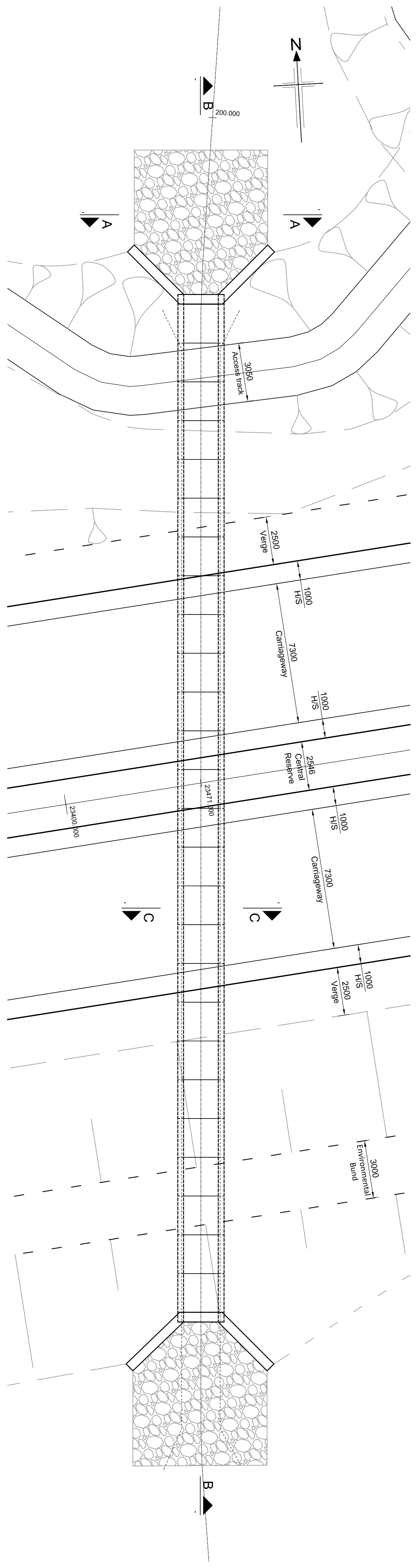
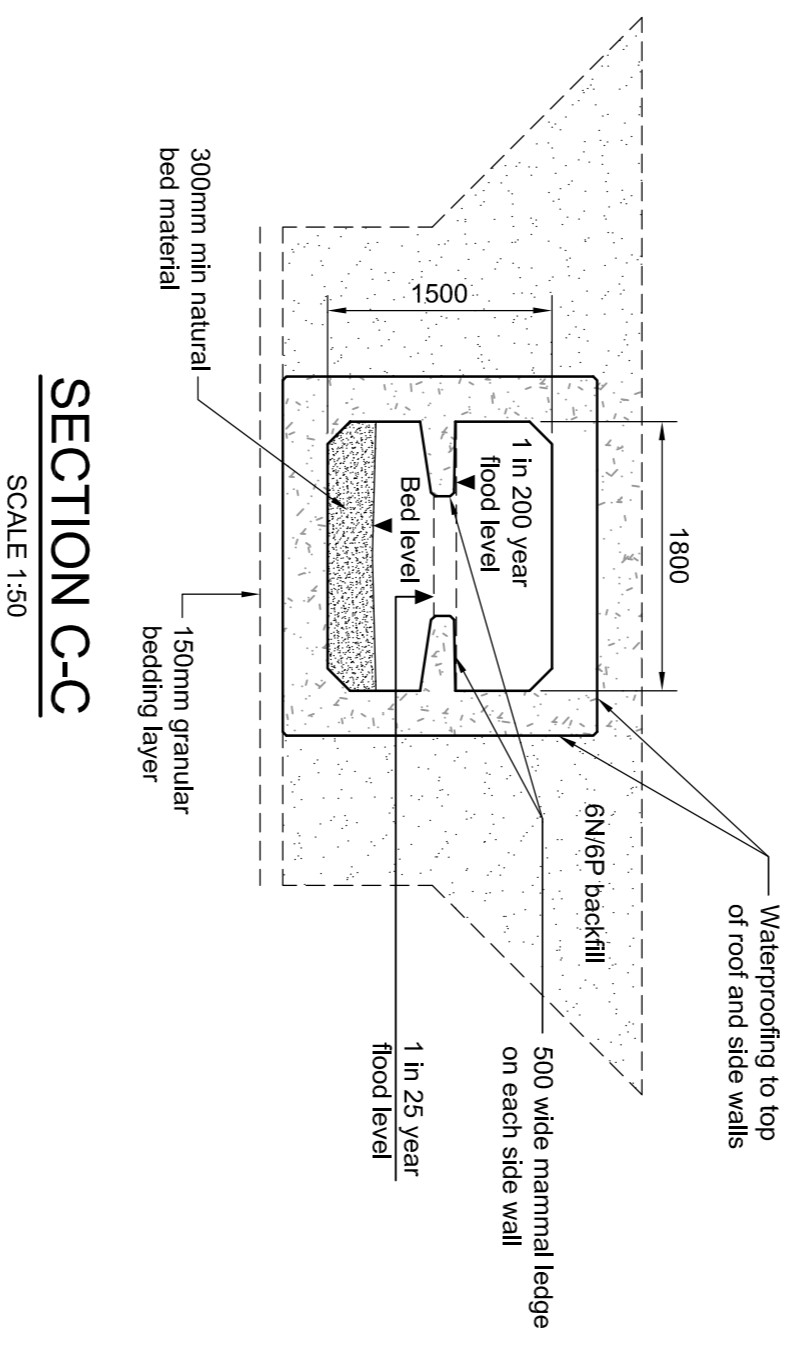
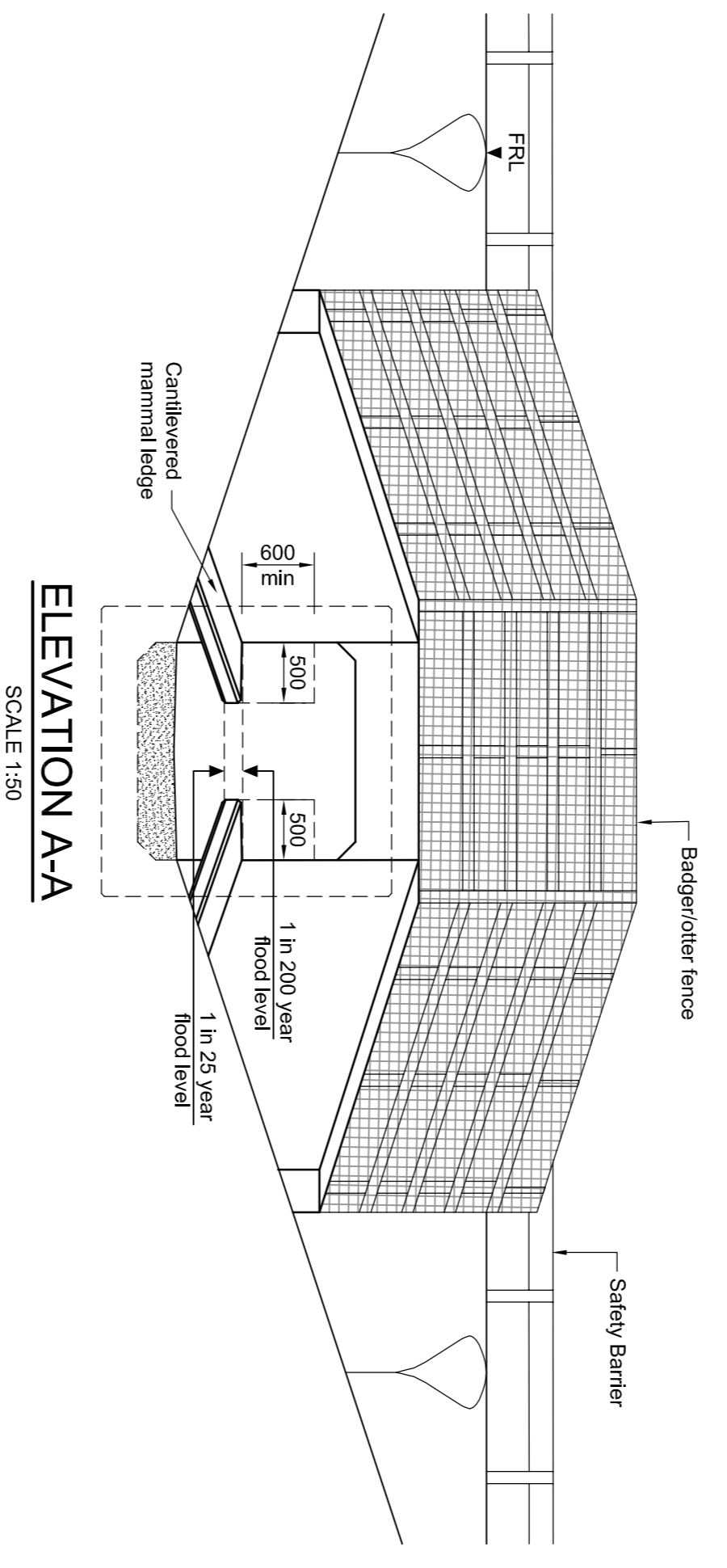
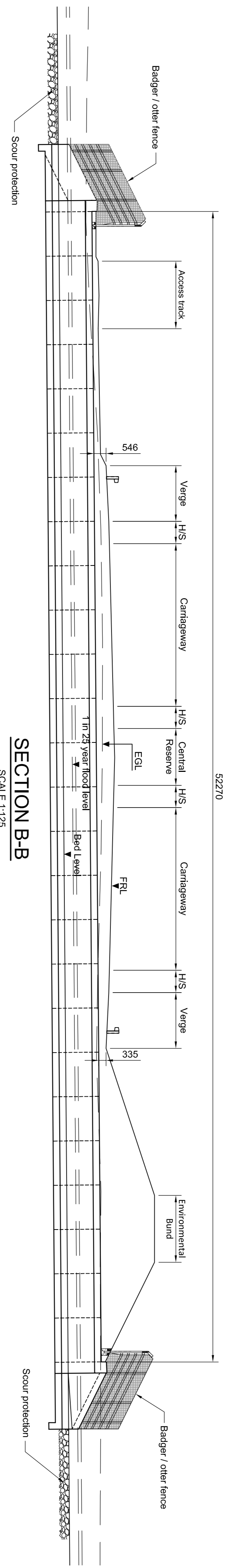

- NOTES:**
1. All dimensions in millimetres unless noted otherwise.
 2. All changes are in metres unless otherwise noted.
 3. Do not scale from this drawing.
 4. All exposed assets to have 25x25 damper unless noted otherwise.
 5. Bedding requirements in accordance with BS EN 14644 or approved equivalent.
 6. All details shown on this drawing are indicative only and subject to change at detail design stage.

Rev	Rev. Date	Purpose of revision	Drawn	Checked	Rev'd	Approved



35 Bonhill St, Glasgow, G2 7JX
 Tel: +44(0)141 209 1144
 www.jacobs.com



**DMRB STAGE 3
 C19 KNOCKNAGILLAN CULVERT
 GENERAL ARRANGEMENT**

FOR INFORMATION

Scale	AS SHOWN @ A1	DO NOT SCALE
Jacobs No.	B2103500	
Bill no.		
Drawing number	B2103500/ST/C19/DR/001	Rev 0

This drawing is not to be used in whole or part other than for the intended purpose and project as defined on this drawing. Refer to the contract for full terms and conditions.

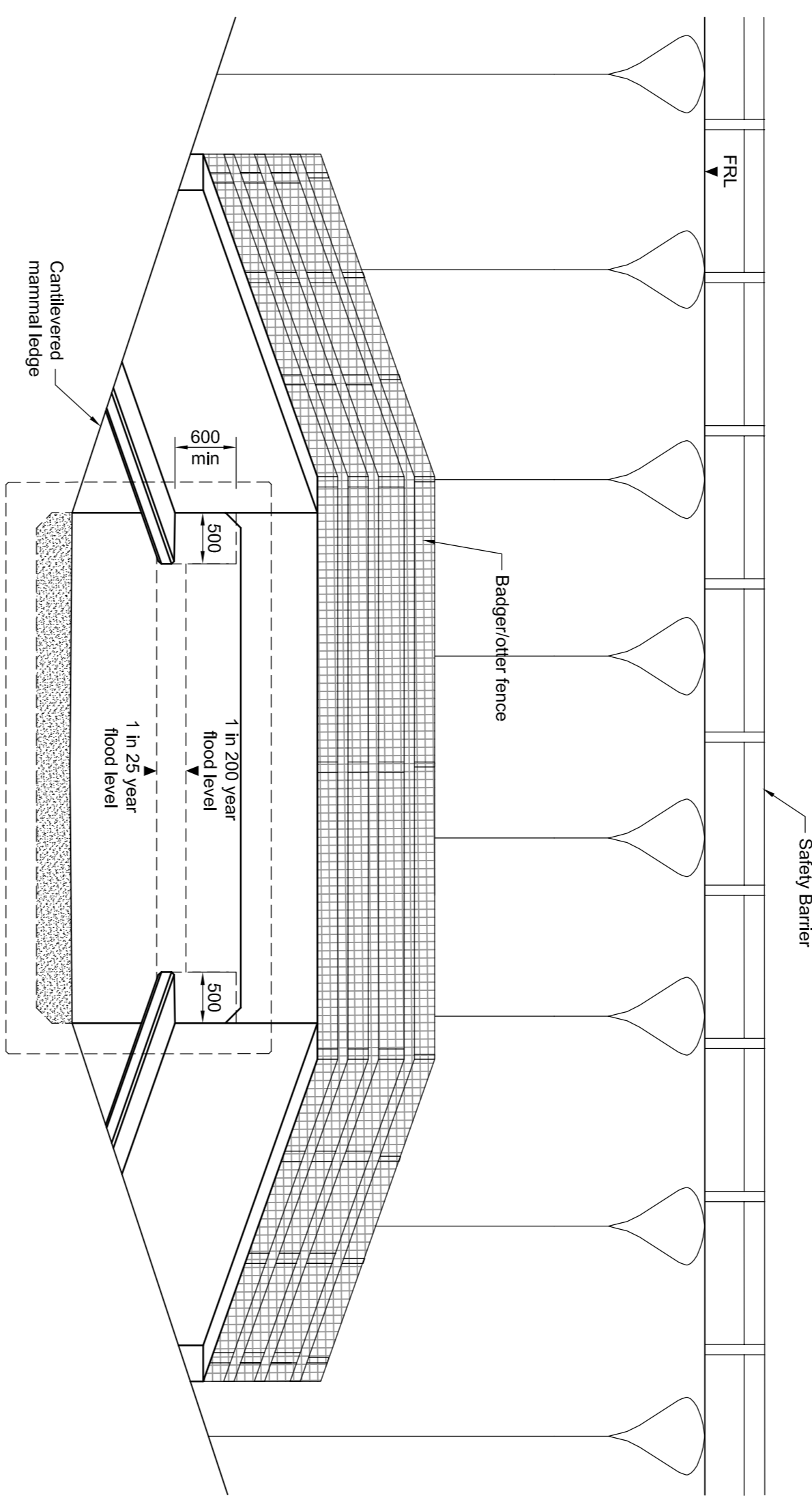
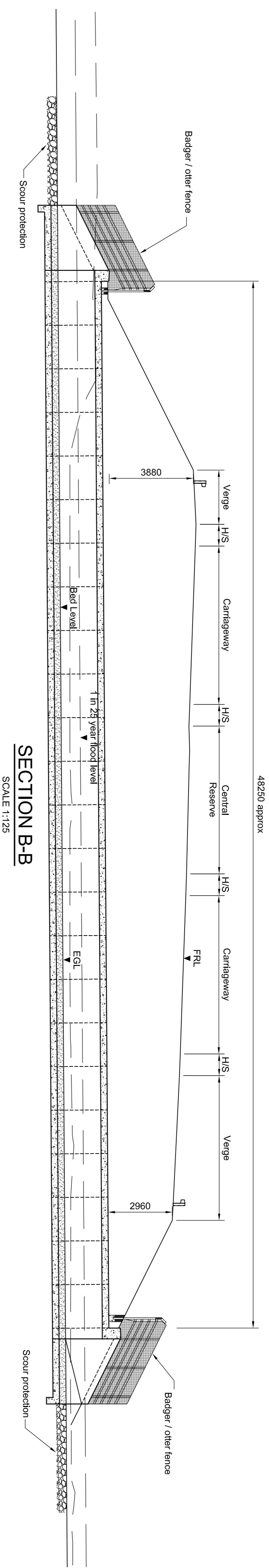

ELEVATION A-A
 SCALE 1:30

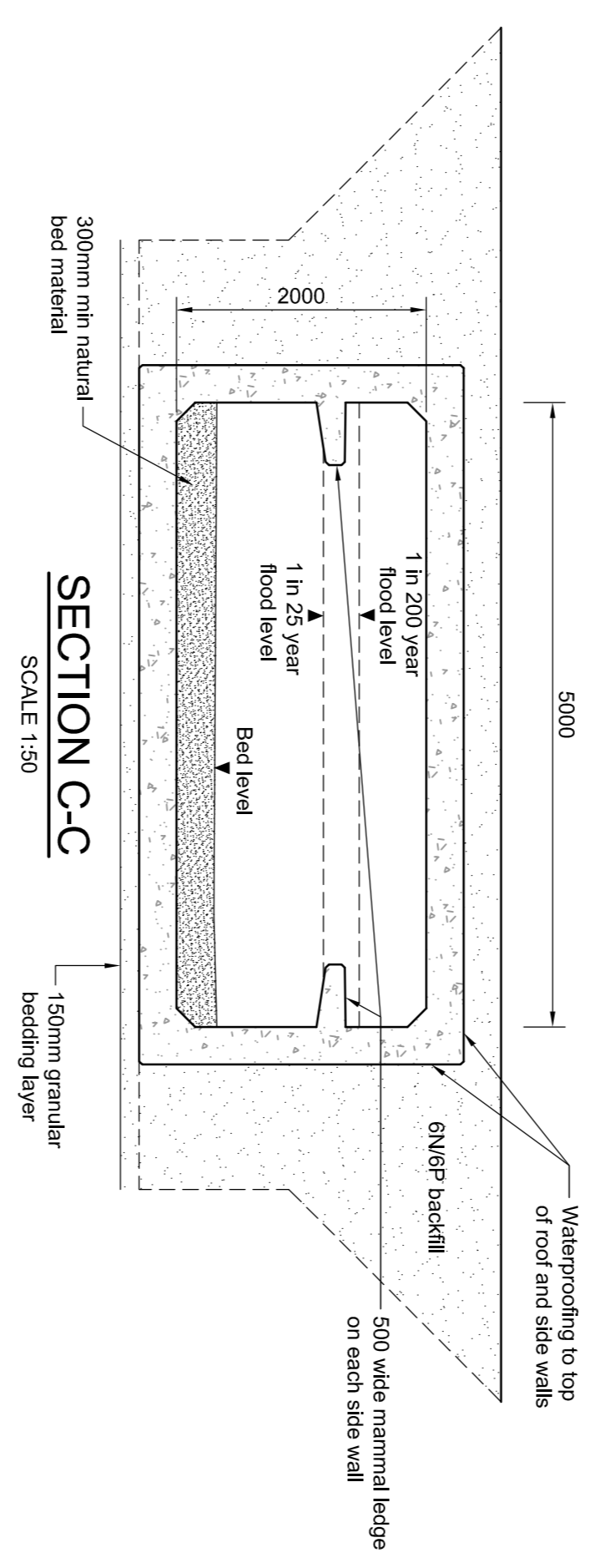

SECTION C-C
 SCALE 1:30

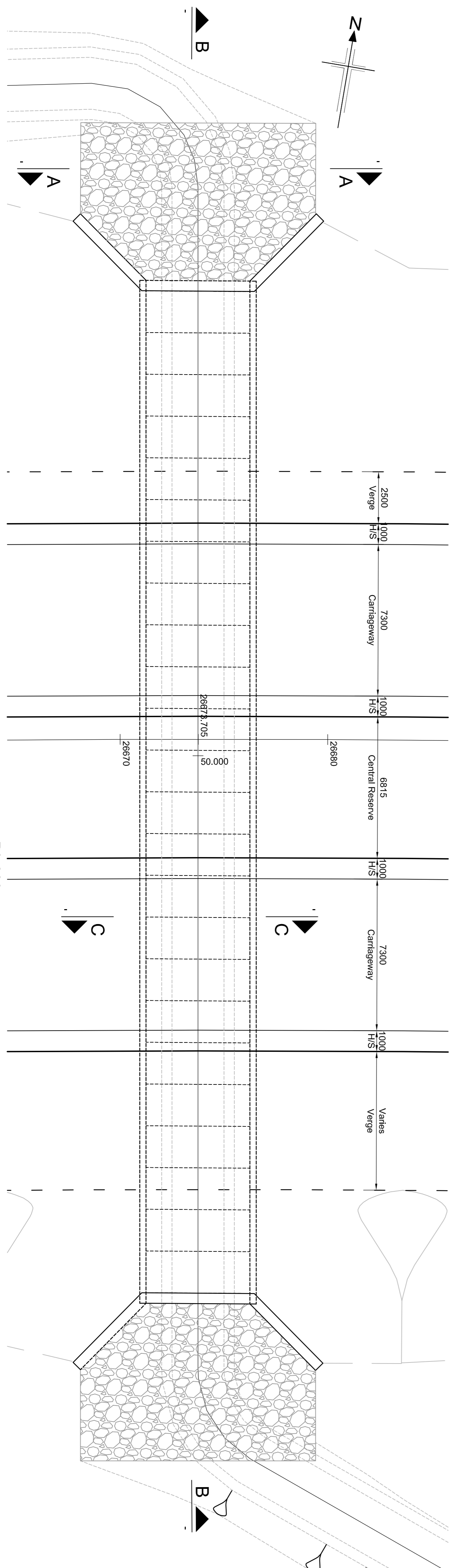

PLAN
 SCALE 1:125

- NOTES:
1. All dimensions in millimetres unless noted otherwise.
 2. All changes are in metres unless otherwise noted.
 3. Do not scale from this drawing.
 4. All exposed assets to have 25x25 damper unless noted otherwise.
 5. Bedding requirements in accordance with BS EN 14694 or approved equivalent.
 6. All details shown on this drawing are indicative only and subject to change at detail design stage.

Rev	Rev. Date	Purpose of revision	Drawn	Checked	Rev'd	Approved

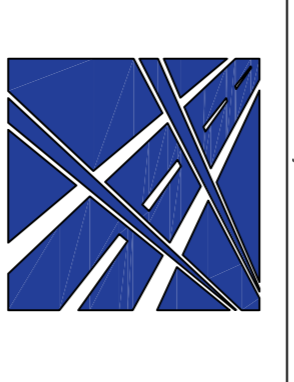

Project
**DMRB STAGE 3
 C20 AULDEARN BURN CULVERT
 GENERAL ARRANGEMENT**

Drawing title
FOR INFORMATION

Scale	AS SHOWN @ A1	DO NOT SCALE
Jacobs No.	B2103500	
Bill no.		
Drawing number	B2103500/ST/C20/DR/001	Rev 0

This drawing is not to be used in whole or part other than for the intended purpose and project as defined on this drawing. Refer to the contract for full terms and conditions.