

SCHEMATIC PLAN

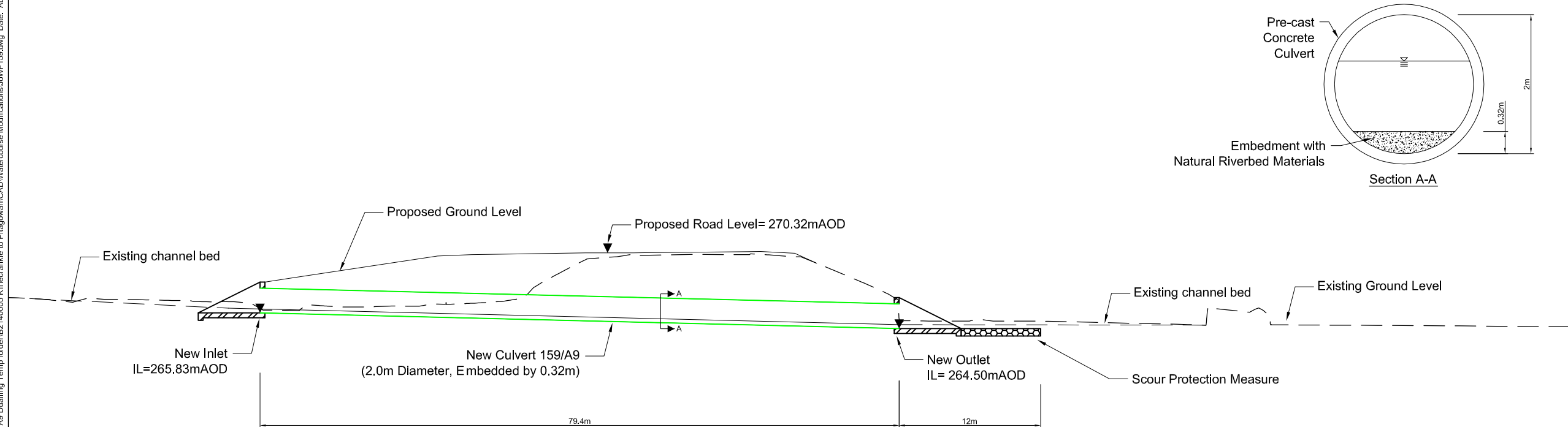

WATERCOURSE 159 LONGSECTION

- Legend:
- New culvert/extension
  - - - Retained culvert
  - Realigned/regraded channel
  - Cascade
  - Inlet/outlet headwall (new)
  - - - Inlet/outlet headwall (retained)
  - Pre-earthworks drain and outfall
  - Access chamber
  - ← Flow direction
  - IL Invert Level

- Notes:
1. All dimensions are in meters unless noted otherwise.
  2. All levels are in meters above ordnance datum.
  3. All details shown on this drawing are indicative only and subject to development at detailed design.
  4. This drawing shall be read in conjunction with the 'Watercourse Crossing report' only and not in isolation.
  5. All 'new' and 'extended' culverts have been designed in accordance with the relevant provisions of DMRB.
  6. Where required 'scour protection measures' shall be provided within the zone indicated on the drawing. The nature and the extent of the scour protection measure will be further developed at detailed design stage in accordance with the relevant provisions of DMRB, taking into account flow hydraulics, channel geometry and channel morphology.
  7. Where shown culverts shall be 'embedded' with natural river deposits to the depth shown.
  8. Where shown 'cascades' are required to safely convey the design flood event (0.5% AEP (200-year) plus allowance for climate change). The cascade geometry shown on the drawing is indicative only and will be subject to further development at detailed design stage. The nature of the cascade will take one of the following forms,
    - Bedrock channel cascade.
    - Natural cascade with natural gravels, cobbles and rock forming individual steps.
    - Concrete cascade with stone pitching.
 The nature of the cascade will be determined at the detailed design stage taking into account hydraulic requirements, topography and nature of the underlying strata and its susceptibility to fluvial erosion.
  9. Where shown mammal ledges will be provided within the culvert in accordance with the relevant provisions of DMRB.

Rev	Rev. Date	Purpose of revision	Drawn	Checkd	Rev'd	Apprv'd
0	18/01/17	FOR INFORMATION				

**JACOBS**  
 95 Bothwell St, Glasgow, G2 7HX  
 Tel: +44(0)141 243 9000 Fax: +44(0)141 226 3109  
 www.jacobs.com



Drawing title  
**KILLIECRANKIE TO GLEN GARRY PROPOSED MODIFICATIONS TO CULVERT ON WATERCOURSE WF159**

Drawing status  
**FOR INFORMATION**

Scale  
 NTS @ A1 DO NOT SCALE

Jacobs No.  
 B2140005

Drawing number  
**Figure A.11.8.62**

Rev  
**0**

File: I:\Glarif\07\PV01\ECBC\BWA\_Joos\B2140000 A9 Dualling Temp folder\B2140000 A9 Dualling CAD\Watercourse Modifications\WF159.dwg Date: Aug 03, 2017 - 10:55 am Plotted by: WOODJA  
 Reproduced by permission of Ordnance Survey on behalf of HMSO. © Crown copyright and database right 2017. All rights reserved. Ordnance Survey Licence number 100046668.

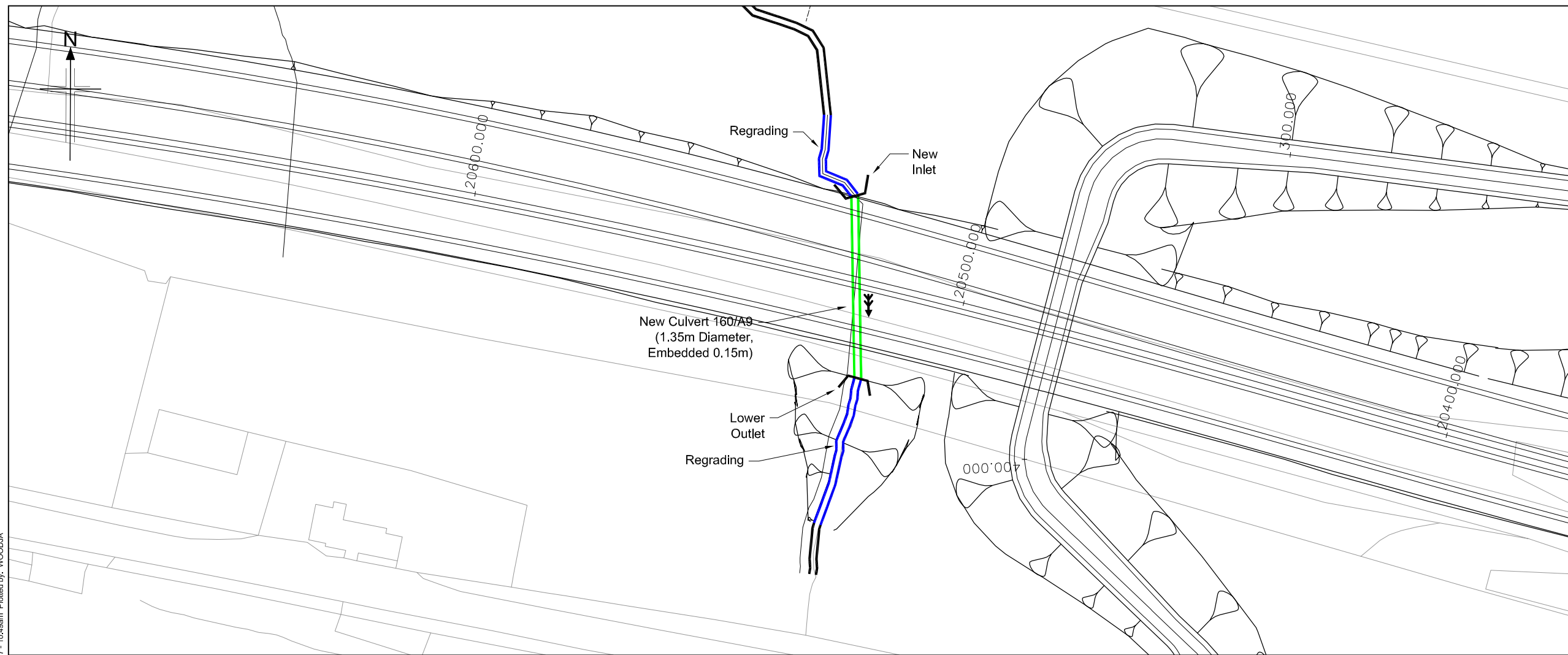

**SCHEMATIC PLAN**

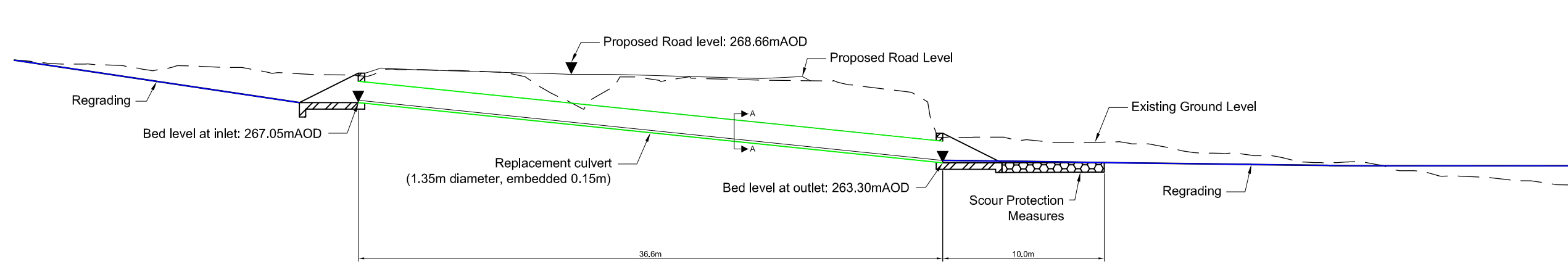
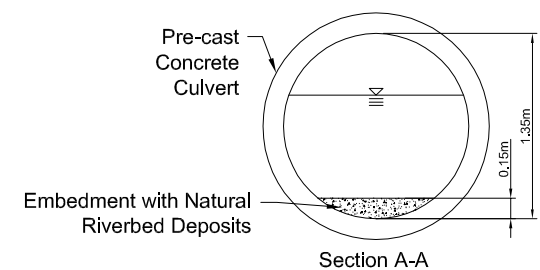

**WATERCOURSE 160 LONGSECTION**

- Legend:**
- New culvert/extension
  - - - Retained culvert
  - Realigned/reggraded channel
  - Cascade
  - Inlet/outlet headwall (new)
  - - - Inlet/outlet headwall (retained)
  - Pre-earthworks drain and outfall
  - Access chamber
  - Flow direction
  - IL Invert Level

- Notes:**
1. All dimensions are in meters unless noted otherwise.
  2. All levels are in meters above ordnance datum.
  3. All details shown on this drawing are indicative only and subject to development at detailed design.
  4. This drawing shall be read in conjunction with the 'Watercourse Crossing report' only and not in isolation.
  5. All 'new' and 'extended' culverts have been designed in accordance with the relevant provisions of DMRB.
  6. Where required 'scour protection measures' shall be provided within the zone indicated on the drawing. The nature and the extent of the scour protection measure will be further developed at detailed design stage in accordance with the relevant provisions of DMRB, taking into account flow hydraulics, channel geometry and channel morphology.
  7. Where shown culverts shall be 'embedded' with natural river deposits to the depth shown.
  8. Where shown 'cascades' are required to safely convey the design flood event (0.5% AEP (200-year) plus allowance for climate change). The cascade geometry shown on the drawing is indicative only and will be subject to further development at detailed design stage. The nature of the cascade will take one of the following forms,
    - Bedrock channel cascade.
    - Natural cascade with natural gravels, cobbles and rock forming individual steps.
    - Concrete cascade with stone pitching.
 The nature of the cascade will be determined at the detailed design stage taking into account hydraulic requirements, topography and nature of the underlying strata and its susceptibility to fluvial erosion.
  9. Where shown mammal ledges will be provided within the culvert in accordance with the relevant provisions of DMRB.

D	18/01/17	FOR INFORMATION	CON	JW	LMG	
Rev	Rev. Date	Purpose of revision	Drawn	Checked	Rev'd	Apprv'd



**KILLIECRANKIE TO GLEN GARRY PROPOSED MODIFICATIONS TO CULVERT ON WATERCOURSE WF160**

Drawing status: **FOR INFORMATION**

Scale: NTS @ A1 | DO NOT SCALE

Jacobs No. B2140005

Drawing number: **Figure A.11.8.63** | Rev: **0**

File: I:\Glarif\07\PV01\1ECBC\BWA\_Joosib2140005 A9 Dualing Temp folder\B2140005 A9 Dualing CAD\Watercourse Modifications\WF160.dwg Date: Aug 03, 2017 - 10:49am Plotted by: WOODJA  
 Reproduced by permission of Ordnance Survey on behalf of HMSO. © Crown copyright and database right 2017. All rights reserved. Ordnance Survey Licence number 100046668.

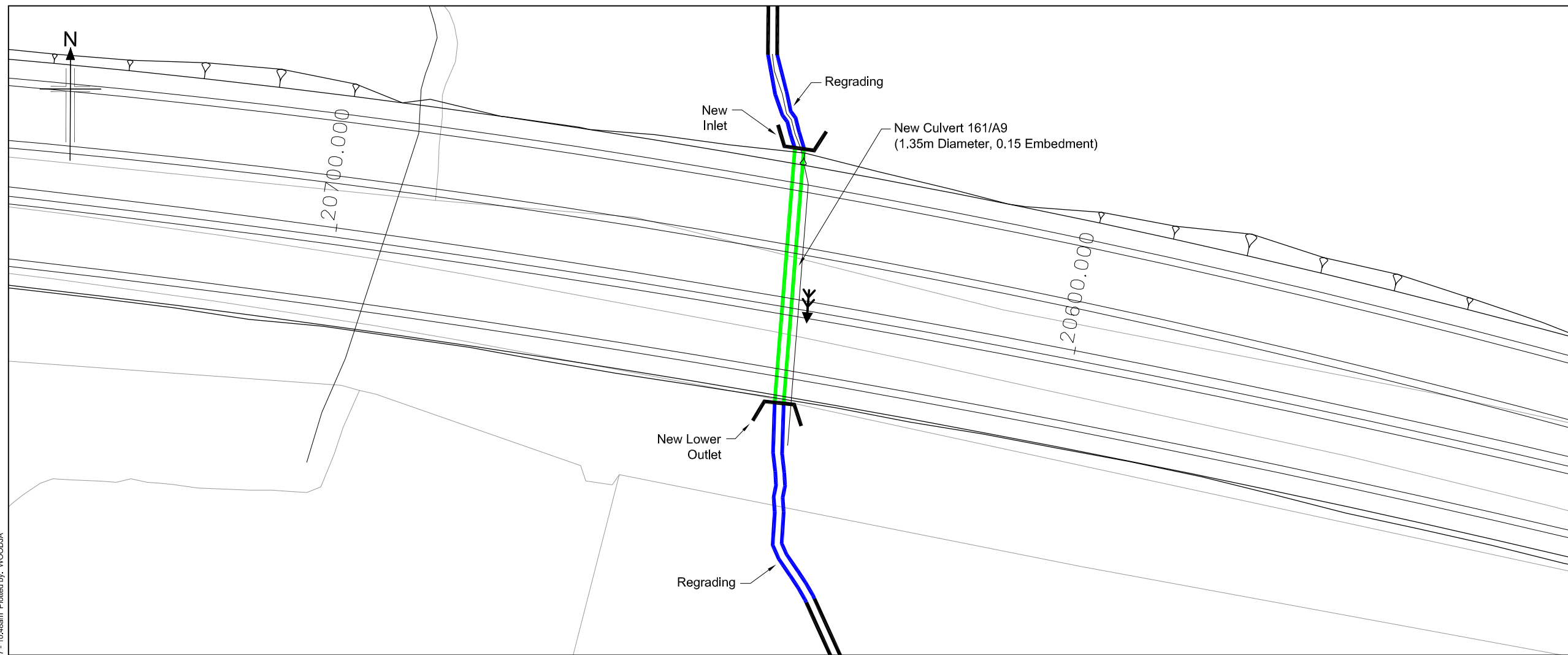

SCHEMATIC PLAN

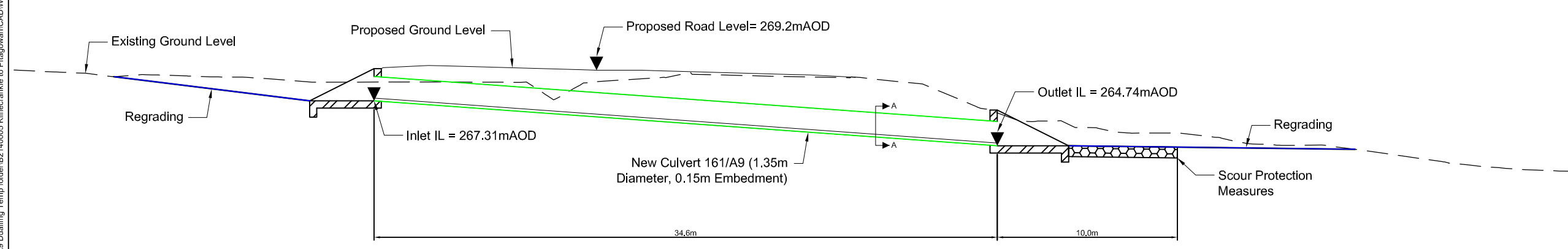
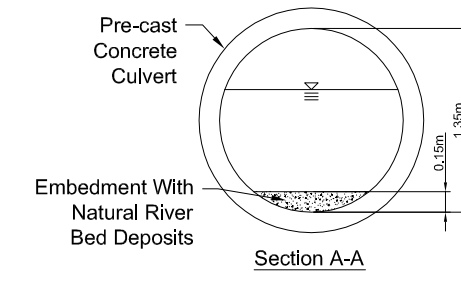

WATERCOURSE 161 LONGSECTION

- Legend:
- New culvert/extension
  - - - Retained culvert
  - Realigned/regraded channel
  - Cascade
  - Inlet/outlet headwall (new)
  - - - Inlet/outlet headwall (retained)
  - Pre-earthworks drain and outfall
  - Access chamber
  - Flow direction
  - IL Invert Level

- Notes:
1. All dimensions are in meters unless noted otherwise.
  2. All levels are in meters above ordnance datum.
  3. All details shown on this drawing are indicative only and subject to development at detailed design.
  4. This drawing shall be read in conjunction with the 'Watercourse Crossing report' only and not in isolation.
  5. All 'new' and 'extended' culverts have been designed in accordance with the relevant provisions of DMRB.
  6. Where required 'scour protection measures' shall be provided within the zone indicated on the drawing. The nature and the extent of the scour protection measure will be further developed at detailed design stage in accordance with the relevant provisions of DMRB, taking into account flow hydraulics, channel geometry and channel morphology.
  7. Where shown culverts shall be 'embedded' with natural river deposits to the depth shown.
  8. Where shown 'cascades' are required to safely convey the design flood event (0.5% AEP (200-year) plus allowance for climate change). The cascade geometry shown on the drawing is indicative only and will be subject to further development at detailed design stage. The nature of the cascade will take one of the following forms,
    - Bedrock channel cascade.
    - Natural cascade with natural gravels, cobbles and rock forming individual steps.
    - Concrete cascade with stone pitching.
 The nature of the cascade will be determined at the detailed design stage taking into account hydraulic requirements, topography and nature of the underlying strata and its susceptibility to fluvial erosion.
  9. Where shown mammal ledges will be provided within the culvert in accordance with the relevant provisions of DMRB.

Rev	Rev. Date	Purpose of revision	Drawn	Checked	Rev'd	Apprv'd
0	18/01/17	FOR INFORMATION	COM	JW	LMG	

**JACOBS**  
 95 Bothwell St, Glasgow, G2 7HX  
 Tel: +44(0)141 243 9000 Fax: +44(0)141 226 3109  
 www.jacobs.com



Drawing title  
**KILLIECRANKIE TO GLEN GARRY PROPOSED MODIFICATIONS TO CULVERT ON WATERCOURSE WF161**

Drawing status  
**FOR INFORMATION**

Scale  
 NTS @ A1 DO NOT SCALE

Jacobs No.  
 B2140005

Drawing number  
**Figure A.11.8.64**

Rev  
**0**

File: I:\Glarif\07\P\01\1\ECBC\BWA\_Jobs\B2140005 A9 Dualling Temp folder\B2140005 A9 Dualling CAD\Watercourse Modifications\WF161.dwg Date: Aug 03, 2017 - 10:48am Plotted by: WOODJA

Reproduced by permission of Ordnance Survey on behalf of HMSO.  
 © Crown copyright and database right 2017. All rights reserved.  
 Ordnance Survey Licence number 100046668.

© Copyright 2017 Jacobs U.K. Limited. The concepts and information contained in this document are the property of Jacobs.  
 Use or copying of this document in whole or in part without the written permission of Jacobs constitutes an infringement of  
 copyright. Limitation: This drawing has been prepared on behalf of, and for the exclusive use of, Jacobs Client, and is subject  
 to, and limited in accordance with, the provisions of the contract between Jacobs and the Client. Jacobs accepts no liability or  
 responsibility whatsoever for, or in respect of, any use of, or reliance upon, this drawing by any third party.

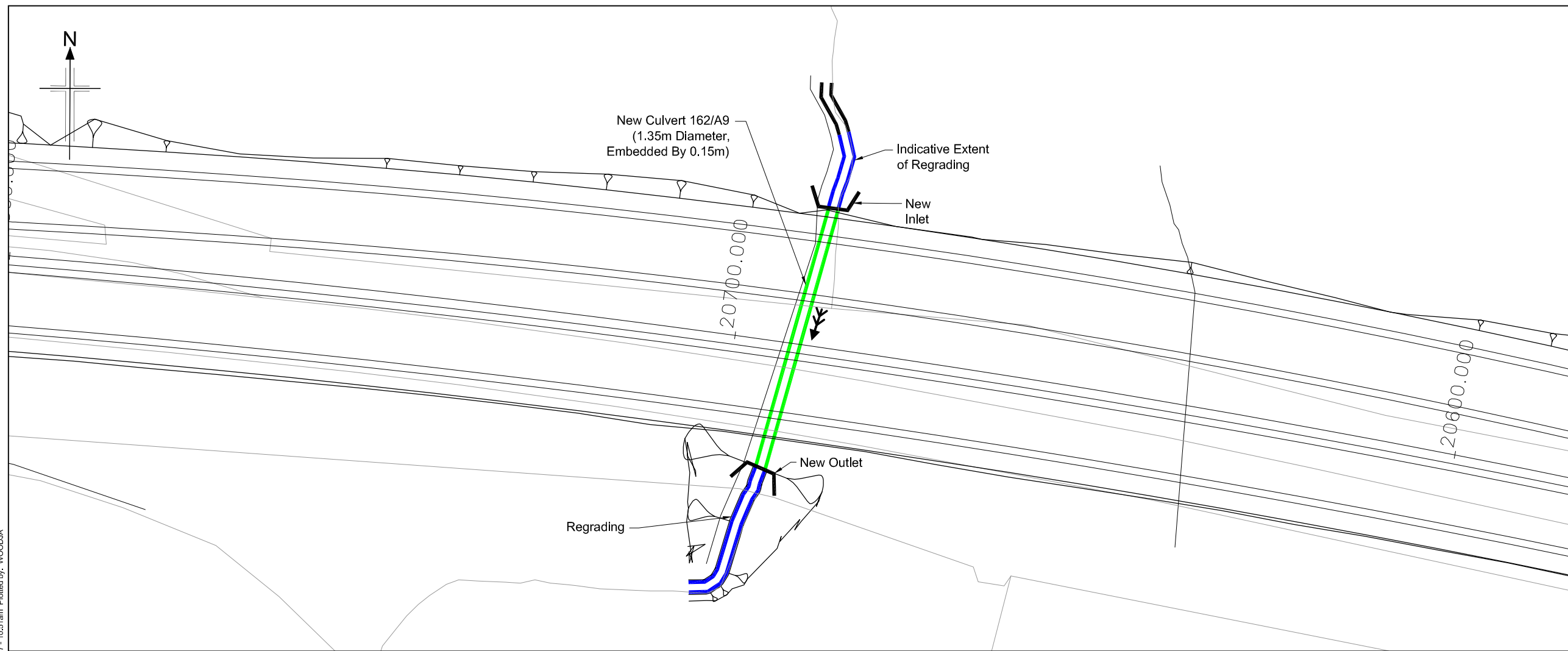

SCHEMATIC PLAN

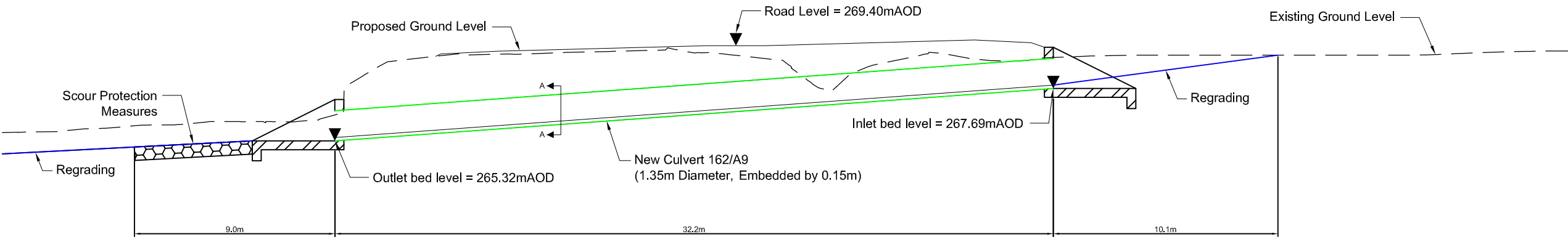
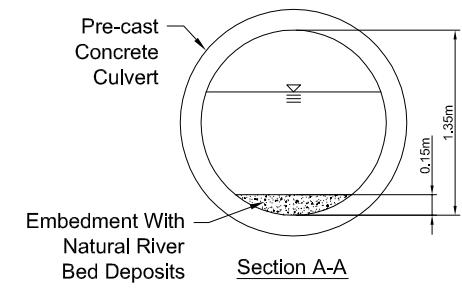

WATERCOURSE 162 LONGSECTION

Legend:

	New culvert/extension
	Retained culvert
	Realigned/regraded channel
	Cascade
	Inlet/outlet headwall (new)
	Inlet/outlet headwall (retained)
	Pre-earthworks drain and outfall
	Access chamber
	Flow direction
	Invert Level

- Notes:
- All dimensions are in meters unless noted otherwise.
  - All levels are in meters above ordnance datum.
  - All details shown on this drawing are indicative only and subject to development at detailed design.
  - This drawing shall be read in conjunction with the 'Watercourse Crossing report' only and not in isolation.
  - All 'new' and 'extended' culverts have been designed in accordance with the relevant provisions of DMRB.
  - Where required 'scour protection measures' shall be provided within the zone indicated on the drawing. The nature and the extent of the scour protection measure will be further developed at detailed design stage in accordance with the relevant provisions of DMRB, taking into account flow hydraulics, channel geometry and channel morphology.
  - Where shown culverts shall be 'embedded' with natural river deposits to the depth shown.
  - Where shown 'cascades' are required to safely convey the design flood event (0.5% AEP (200-year) plus allowance for climate change). The cascade geometry shown on the drawing is indicative only and will be subject to further development at detailed design stage. The nature of the cascade will take one of the following forms,
    - Bedrock channel cascade.
    - Natural cascade with natural gravels, cobbles and rock forming individual steps.
    - Concrete cascade with stone pitching.
 The nature of the cascade will be determined at the detailed design stage taking into account hydraulic requirements, topography and nature of the underlying strata and its susceptibility to fluvial erosion.
  - Where shown mammal ledges will be provided within the culvert in accordance with the relevant provisions of DMRB.

D	18/01/17	FOR INFORMATION	CON	JW	LMG	
Rev	Rev. Date	Purpose of revision	Drawn	Checked	Rev'd	Appr'd



95 Bothwell St, Glasgow, G2 7HX  
Tel: +44(0)141 243 9000 Fax: +44(0)141 226 3109  
www.jacobs.com



Drawing title  
**KILLIECRANKIE TO GLEN GARRY PROPOSED MODIFICATIONS TO CULVERT ON WATERCOURSE WF162**

Drawing status  
**FOR INFORMATION**

Scale  
NTS @ A1 DO NOT SCALE

Jacobs No.  
B2140005

Drawing number  
Figure A.11.8.65

Rev  
0

File: I:\Glarif\07\PV01\1ECBC\BWA\_Joos\B2140005 A9 Dualing Temp folder\B2140005 Killiecrankie to Pitegowan\CAD\Watercourse Modifications\WF162.dwg Date: Aug 03, 2017 - 10:45 am Plotted by: WOODJA  
 Reproduced by permission of Ordnance Survey on behalf of HMSO. © Crown copyright and database right 2017. All rights reserved. Ordnance Survey Licence number 100046668.

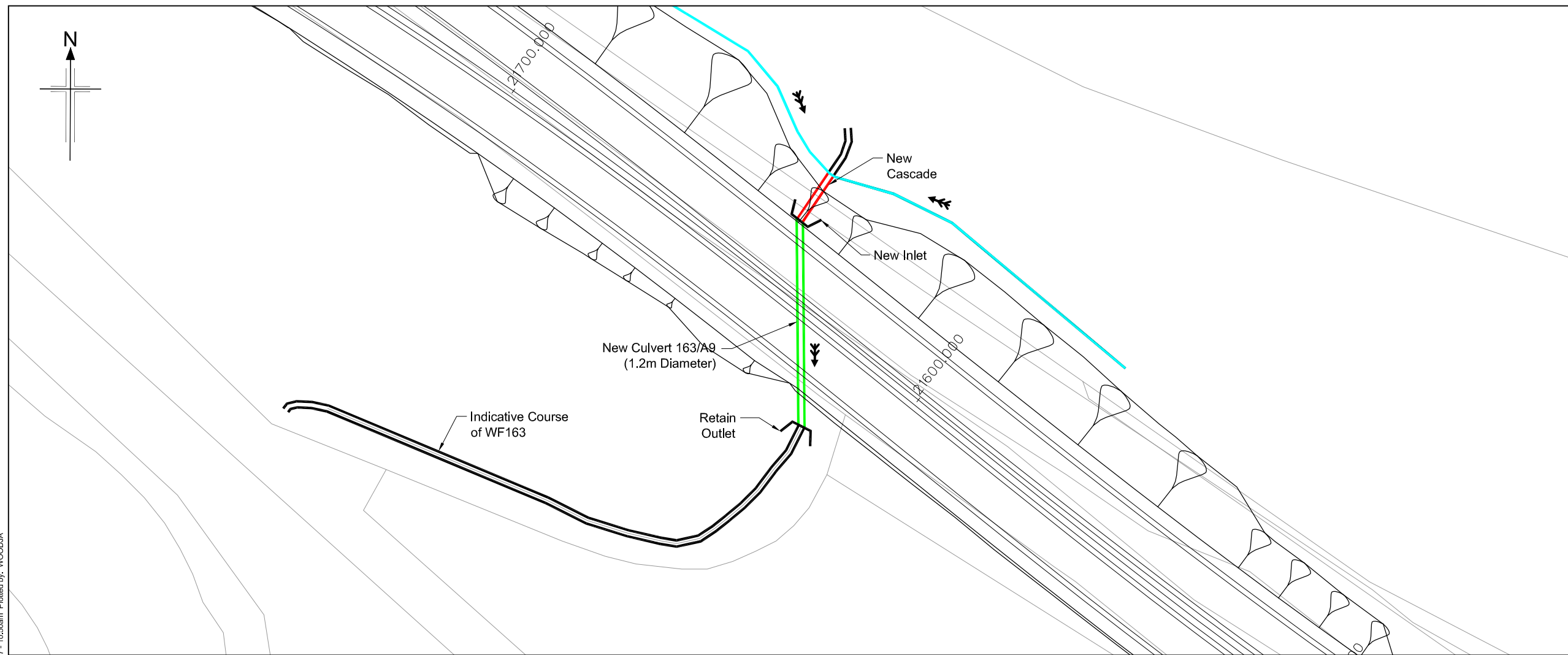

SCHEMATIC PLAN

- Legend:
- New culvert/extension
  - - - Retained culvert
  - Realigned/regraded channel
  - Cascade
  - Inlet/outlet headwall (new)
  - - - Inlet/outlet headwall (retained)
  - Pre-earthworks drain and outfall
  - Access chamber
  - Flow direction
  - IL Invert Level

- Notes:
1. All dimensions are in meters unless noted otherwise.
  2. All levels are in meters above ordnance datum.
  3. All details shown on this drawing are indicative only and subject to development at detailed design.
  4. This drawing shall be read in conjunction with the 'Watercourse Crossing report' only and not in isolation.
  5. All 'new' and 'extended' culverts have been designed in accordance with the relevant provisions of DMRB.
  6. Where required 'scour protection measures' shall be provided within the zone indicated on the drawing. The nature and the extent of the scour protection measure will be further developed at detailed design stage in accordance with the relevant provisions of DMRB, taking into account flow hydraulics, channel geometry and channel morphology.
  7. Where shown culverts shall be 'embedded' with natural river deposits to the depth shown.
  8. Where shown 'cascades' are required to safely convey the design flood event (0.5% AEP (200-year) plus allowance for climate change). The cascade geometry shown on the drawing is indicative only and will be subject to further development at detailed design stage. The nature of the cascade will take one of the following forms,
    - Bedrock channel cascade.
    - Natural cascade with natural gravels, cobbles and rock forming individual steps.
    - Concrete cascade with stone pitching.
 The nature of the cascade will be determined at the detailed design stage taking into account hydraulic requirements, topography and nature of the underlying strata and its susceptibility to fluvial erosion.
  9. Where shown mammal ledges will be provided within the culvert in accordance with the relevant provisions of DMRB.

File: I:\Glarif\07\PV01\ECBC\BWA\_Joos\B2140005 A9 Dualling Temp folder\B2140005 A9 Dualling CAD\Watercourse Modifications\WF163.dwg Date: Aug 03, 2017 - 10:50am Plotted by: WOODJA

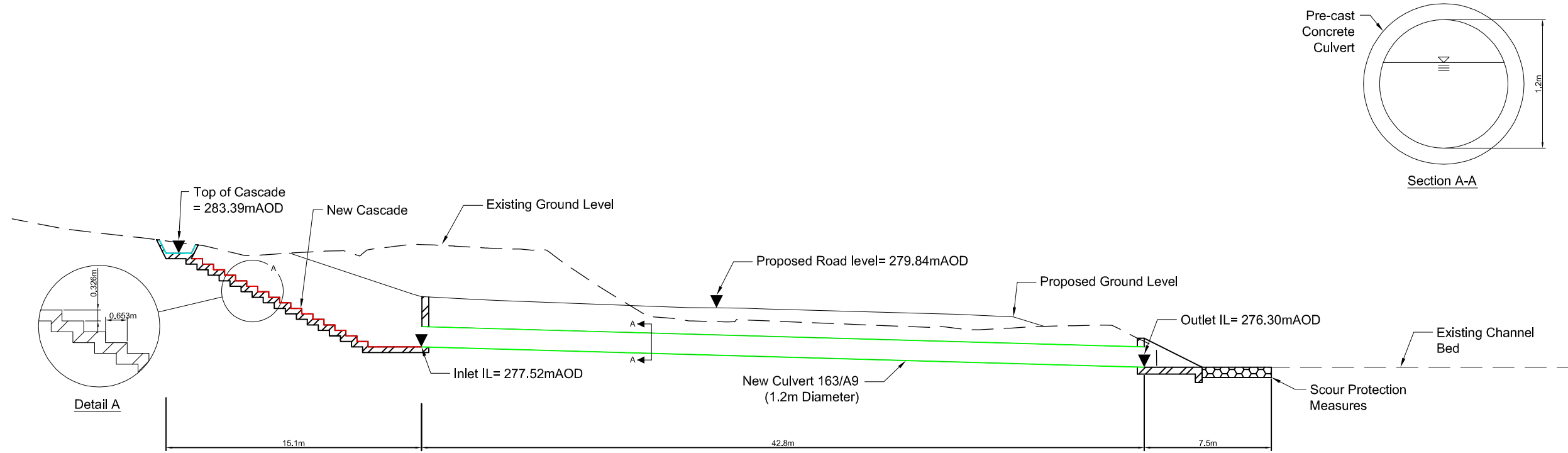

WATERCOURSE 163 LONGSECTION

Rev	Rev. Date	Purpose of revision	Drawn	Checkd	Rev'd	Apprv'd
0	18/01/17	FOR INFORMATION				

**JACOBS**  
 95 Bothwell St, Glasgow, G2 7HX  
 Tel: +44(0)141 243 9000 Fax: +44(0)141 226 3109  
 www.jacobs.com



**KILLIECRANKIE TO GLEN GARRY  
 PROPOSED MODIFICATIONS  
 TO CULVERT ON  
 WATERCOURSE WF163**

Drawing status: **FOR INFORMATION**

Scale: NTS @ A1 DO NOT SCALE

Jacobs No. B2140005

Drawing number: **Figure A.11.8.66** Rev: **0**

Reproduced by permission of Ordnance Survey on behalf of HMSO.  
 © Crown copyright and database right 2017. All rights reserved.  
 Ordnance Survey Licence number 100046668.

© Copyright 2017 Jacobs U.K. Limited. The concepts and information contained in this document are the property of Jacobs. Use or copying of this document in whole or in part without the written permission of Jacobs constitutes an infringement of copyright. Limitation: This drawing has been prepared on behalf of, and for the exclusive use of Jacobs Client, and is subject to, and issued in accordance with, the provisions of the contract between Jacobs and the Client. Jacobs accepts no liability or responsibility whatsoever for, or in respect of, any use of, or reliance upon, this drawing by any third party.

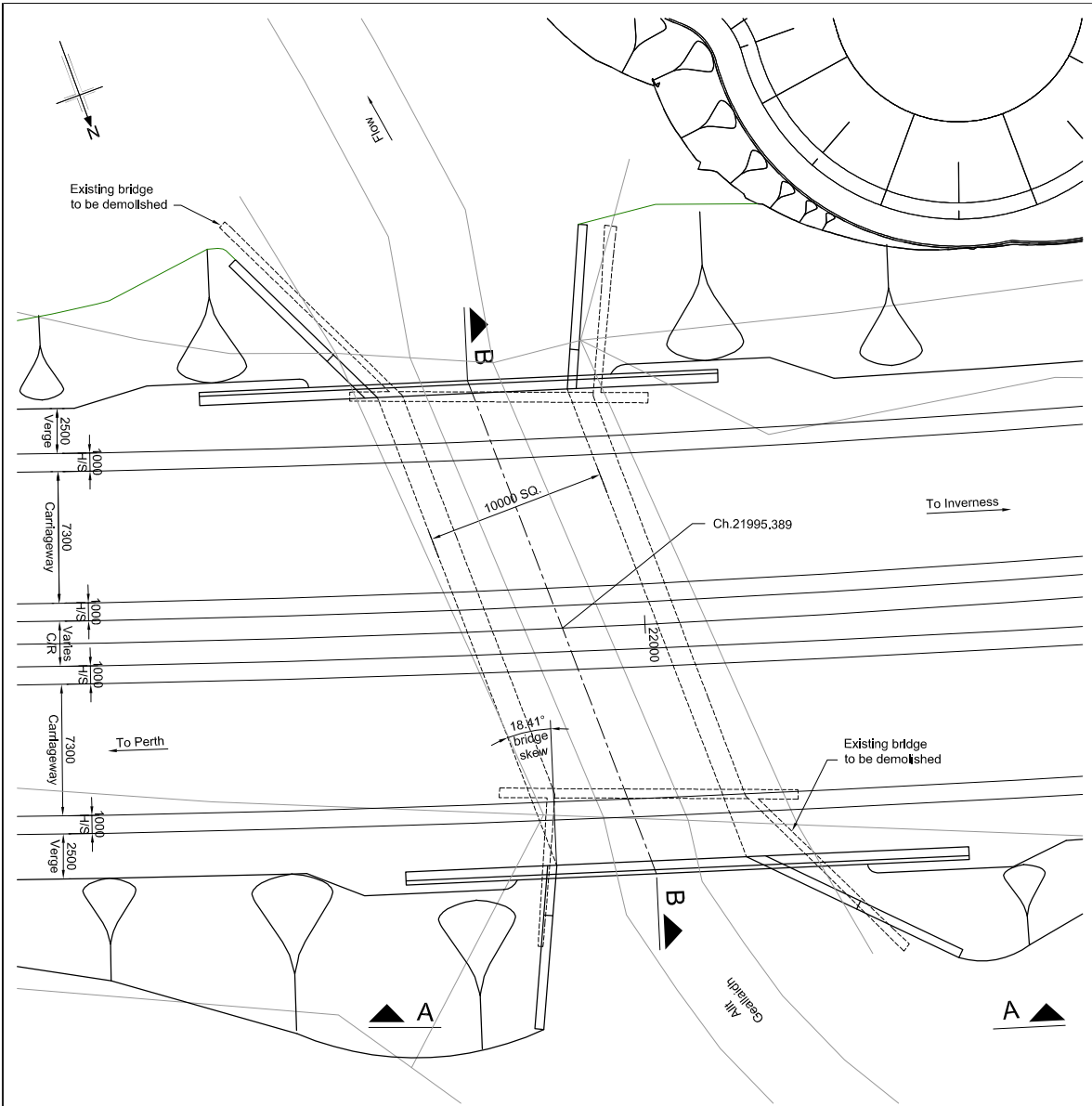

**PLAN**  
SCALE 1:200

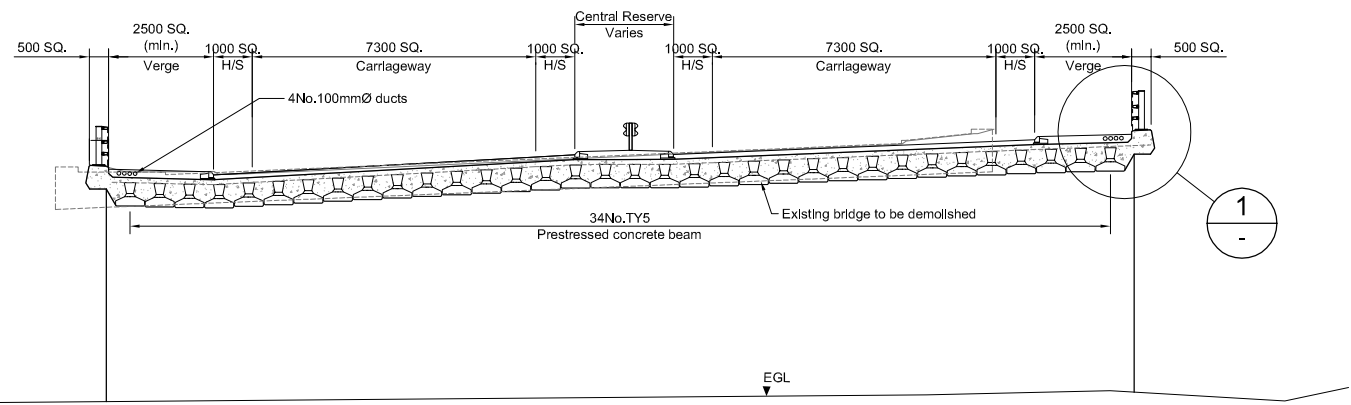

**SECTION B-B**  
SCALE 1:100

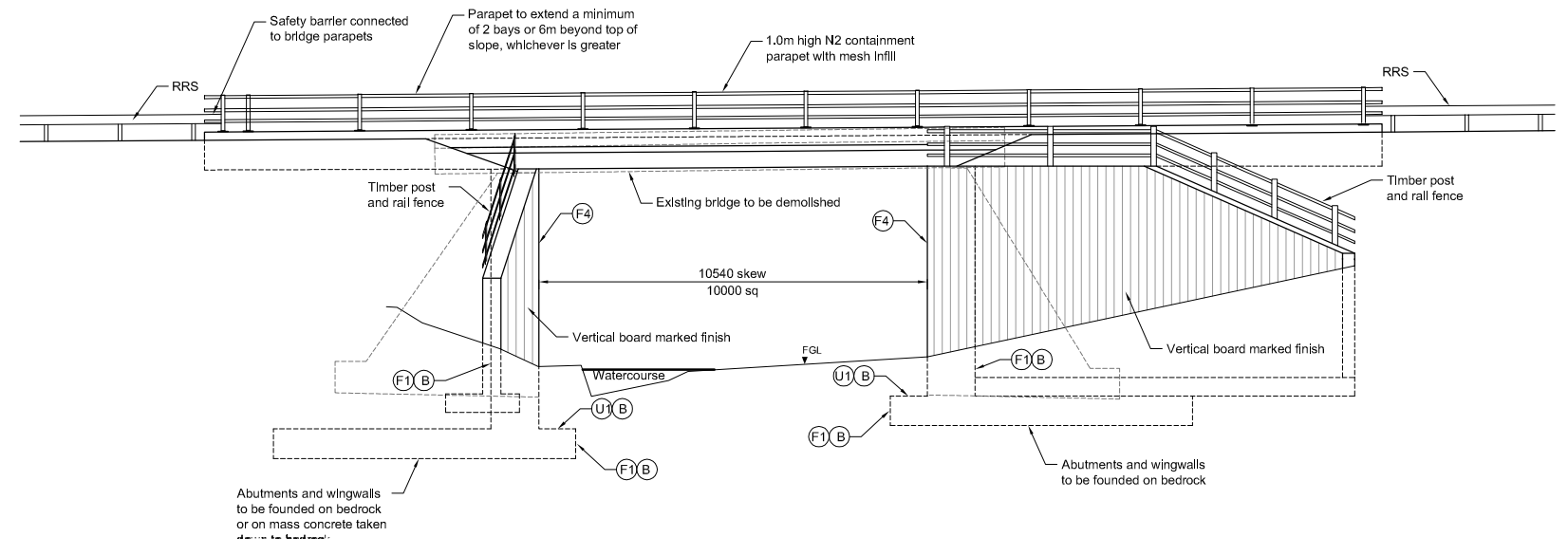

**ELEVATION A-A**  
SCALE 1:100

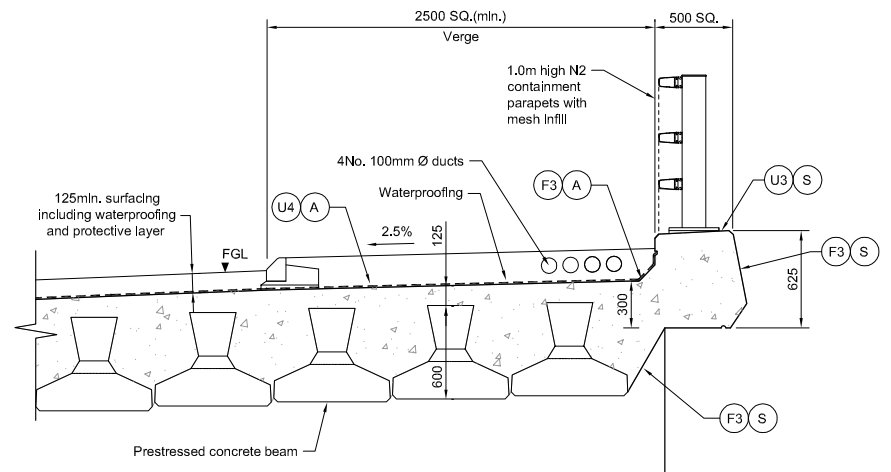

**DETAIL 1**  
SCALE 1:25

SAFETY, HEALTH AND ENVIRONMENTAL INFORMATION	
In addition to the hazards/risks normally associated with the types of work detailed on this drawing, note the following:	
CONSTRUCTION	
Service survey required pre-construction Potential presence in existing structure of harmful substances causing damage to health to be established pre-demolition. Structure stability to be checked during break-out / demolition of existing structure Nature and position of the existing structure to be verified pre-construction by undertaking investigations Condition of existing structure may not be as anticipated. Existing structure may not be accurately represented by record drawings. Position of existing structure may not be as shown	
MAINTENANCE / CLEANING	
None	
DECOMMISSIONING / DEMOLITION	
It is assumed that all works will be carried out by a competent contractor working, where appropriate, to an approved method statement	

- Notes.
- All dimensions are in millimetres unless noted otherwise.
  - All levels are in metres Above Ordnance Datum.
  - All chainages are in metres.
  - All exposed arrises to have 25x25 chamfers unless noted otherwise.
  - Concrete finishes denoted thus:  
(F) - Formed  
(U) - Unformed
  - Concrete protection to be as follows:  
(S) - Surface impregnation in accordance with BD43 of the DMRB.  
(A) - Spray applied waterproofing in accordance with CI 2003 of the Specification.  
(B) - Waterproofing of all buried concrete surfaces in accordance with CI 2004 of the Specification.
  - All details shown on this drawing are indicative only and subject to development.

P2	15/05/17	DMRB Stage 3 Report - Draft	MG	IA	MAM	
P1	11/10/16	Design Flt 4 - Issued for Review	MG	IA	MAM	ELM
Rev	Rev. Date	Purpose of revision	Drawn	Checked	Rev'd	Appr'd



Client  
Project  
Drawing title  
**KILLIECRANKIE TO GLEN GARRY  
ALLT GEALLAIDH  
UNDERBRIDGE  
GENERAL ARRANGEMENT**

Scale	AS SHOWN @ A1	DO NOT SCALE
Jacobs No.	B2140005	
Drawing number	Figure A.11.8.67	Rev P2

This drawing is not to be used in whole or part other than for the intended purpose and project as defined on this drawing. Refer to the contract for full terms and conditions.

File: A:\B2140005\Killiecrankie to Pitagowan\CAD\Watercourse Modifications\A9\A9\_P2 - A9 T80 Allt Geallaidh.dwg Date: Nov 16, 2017 - 6:16pm Plotted by: WOODJUA

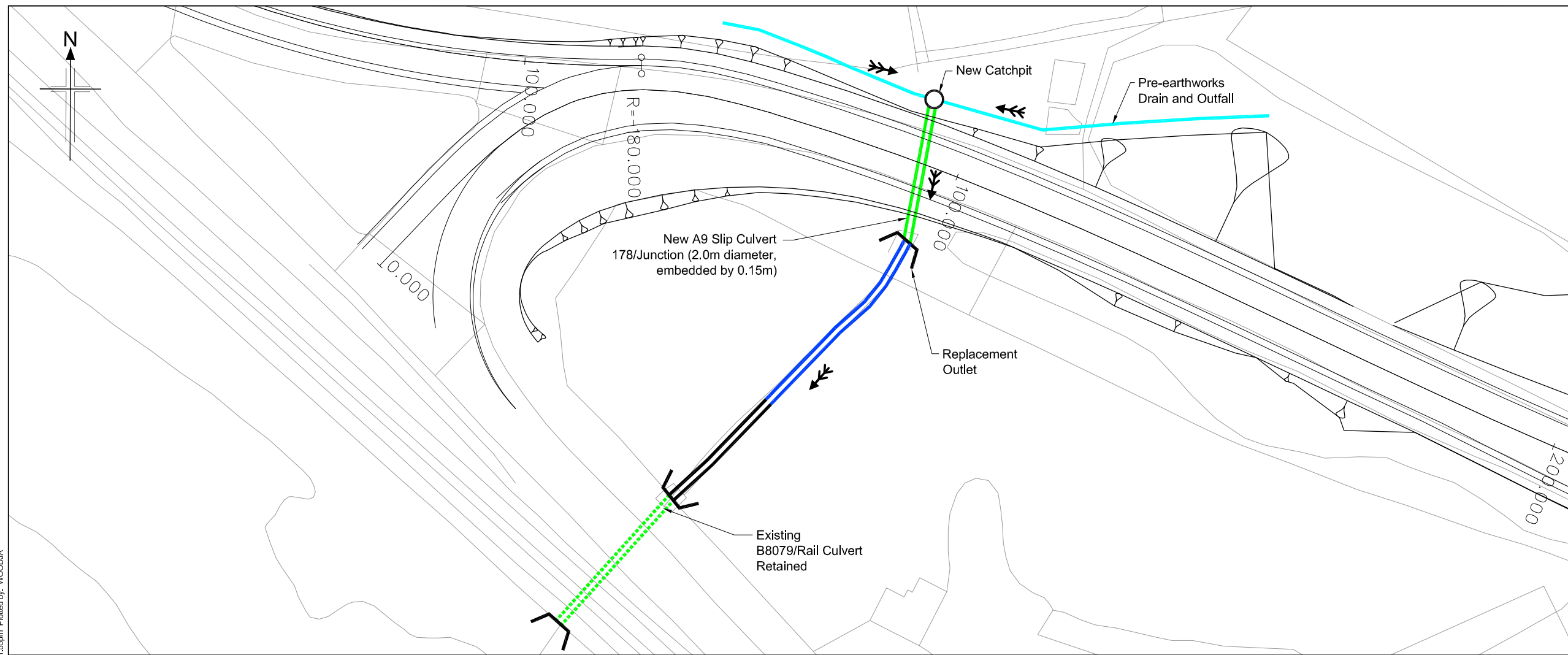

SCHEMATIC PLAN

- Legend:
- New culvert/extension
  - - - Retained culvert
  - Realigned/regraded channel
  - Cascade
  - Inlet/outlet headwall (new)
  - - - Inlet/outlet headwall (retained)
  - Pre-earthworks drain and outfall
  - Access chamber
  - Flow direction
  - IL

- Notes:
1. All dimensions are in meters unless noted otherwise.
  2. All levels are in meters above ordnance datum.
  3. All details shown on this drawing are indicative only and subject to development at detailed design.
  4. This drawing shall be read in conjunction with the 'Watercourse Crossing report' only and not in isolation.
  5. All 'new' and 'extended' culverts have been designed in accordance with the relevant provisions of DMRB.
  6. Where required 'scour protection measures' shall be provided within the zone indicated on the drawing. The nature and the extent of the scour protection measure will be further developed at detailed design stage in accordance with the relevant provisions of DMRB, taking into account flow hydraulics, channel geometry and channel morphology.
  7. Where shown culverts shall be 'embedded' with natural river deposits to the depth shown.
  8. Where shown 'cascades' are required to safely convey the design flood event (0.5% AEP (200-year) plus allowance for climate change). The cascade geometry shown on the drawing is indicative only and will be subject to further development at detailed design stage. The nature of the cascade will take one of the following forms,
    - Bedrock channel cascade.
    - Natural cascade with natural gravels, cobbles and rock forming individual steps.
    - Concrete cascade with stone pitching.
 The nature of the cascade will be determined at the detailed design stage taking into account hydraulic requirements, topography and nature of the underlying strata and its susceptibility to fluvial erosion.
  9. Where shown mammal ledges will be provided within the culvert in accordance with the relevant provisions of DMRB.

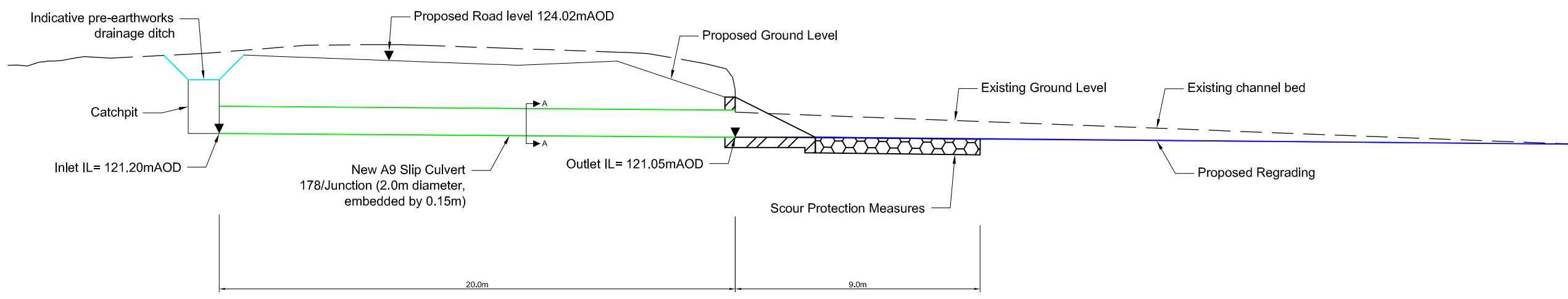
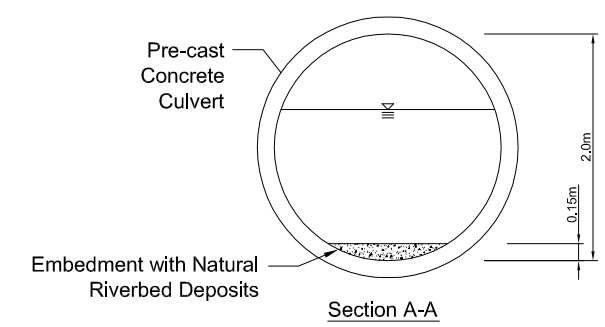

WATERCOURSE 178 LONGSECTION

Rev	Rev. Date	Purpose of revision	Drawn	Checked	Rev'd	Apprv'd
0	23/01/17	FOR INFORMATION				



Drawing title  
**KILLIECRANKIE TO GLEN GARRY  
 PROPOSED MODIFICATIONS  
 TO CULVERT ON  
 WATERCOURSE WF178**

Drawing status: **FOR INFORMATION**

Scale	NTS @ A1	DO NOT SCALE
Jacobs No.	B2140005	

Drawing number: **Figure A.11.8.68** Rev: **0**

File: I:\Glen\07\PV01\ECBC\BWA\_Job\B2140005 A9 Dualing Temp folder\B2140005 A9 Dualing\CAD\Watercourse Modifications\WF178.dwg Date: Jul 27, 2017 - 15:56pm Plotted by: WOODJA

Reproduced by permission of Ordnance Survey on behalf of HMSO.  
 © Crown copyright and database right 2017. All rights reserved.  
 Ordnance Survey Licence number 100046668.

© Copyright 2017 Jacobs U.K. Limited. The concepts and information contained in this document are the property of Jacobs.  
 Use or copying of this document in whole or in part without the written permission of Jacobs constitutes an infringement of  
 copyright. Limitation: This drawing has been prepared on behalf of, and for the exclusive use of, Jacobs Client, and is subject  
 to, and limited in accordance with, the provisions of the contract between Jacobs and the Client. Jacobs accepts no liability or  
 responsibility whatsoever for, or in respect of, any use of, or reliance upon, this drawing by any third party.

- Notes.**
1. All dimensions are in millimetres unless noted otherwise.
  2. All levels are in metres Above Ordnance Datum.
  3. All chainages are in metres.
  4. All exposed arrises to have 25x25 chamfers unless noted otherwise.
  5. All details shown on this drawing are indicative only and subject to development.

SAFETY, HEALTH AND ENVIRONMENTAL INFORMATION	
In addition to the hazards/risks normally associated with the types of work detailed on this drawing, note the following:	
<b>CONSTRUCTION</b>	- Service survey required pre-construction - Position of existing structure may not be as shown
<b>MAINTENANCE / CLEANING</b>	- None
<b>DECOMMISSIONING / DEMOLITION</b>	- None
It is assumed that all works will be carried out by a competent contractor working, where appropriate, to an approved method statement	

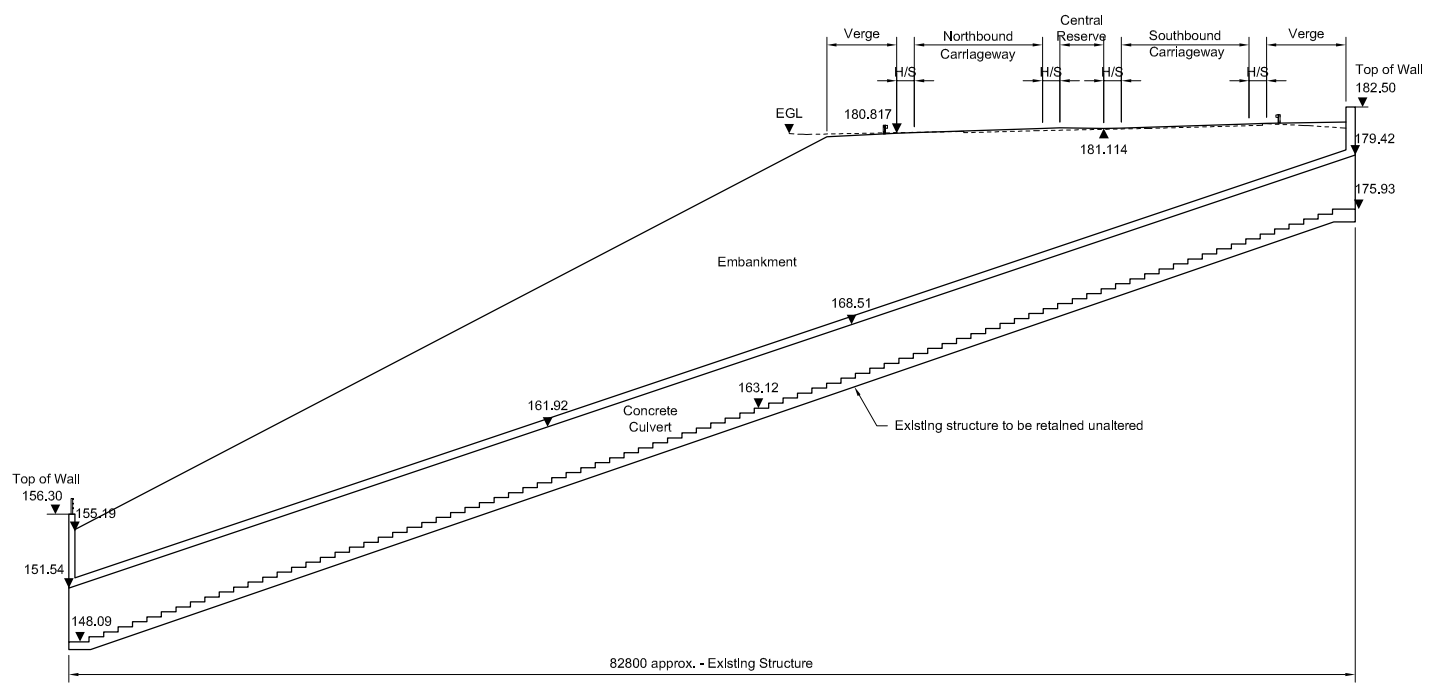

**SECTION A-A**  
Scale 1:250

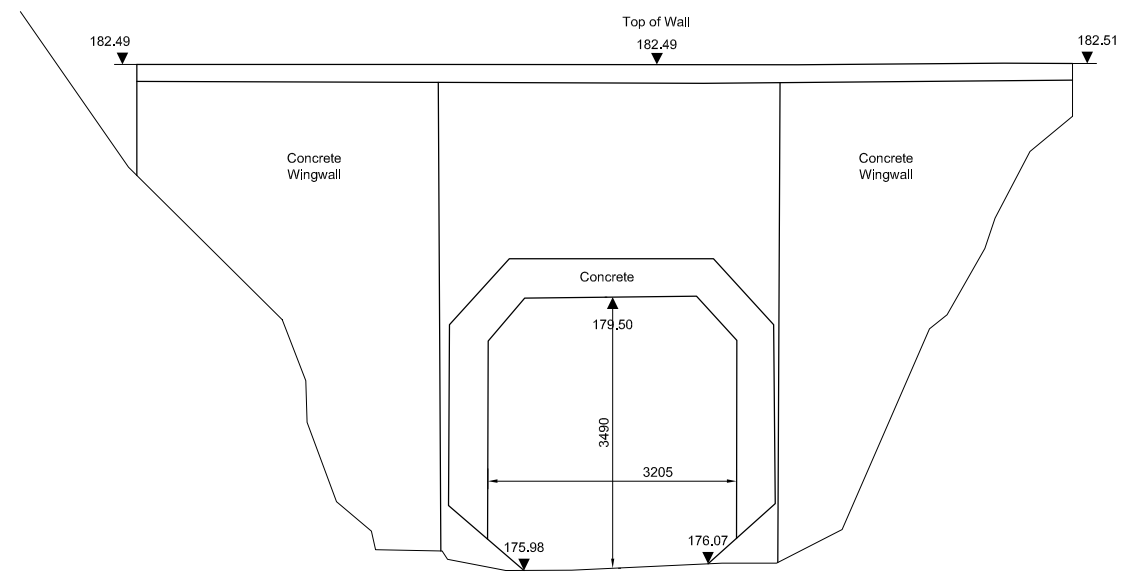

**ELEVATION B-B**  
Scale 1:50

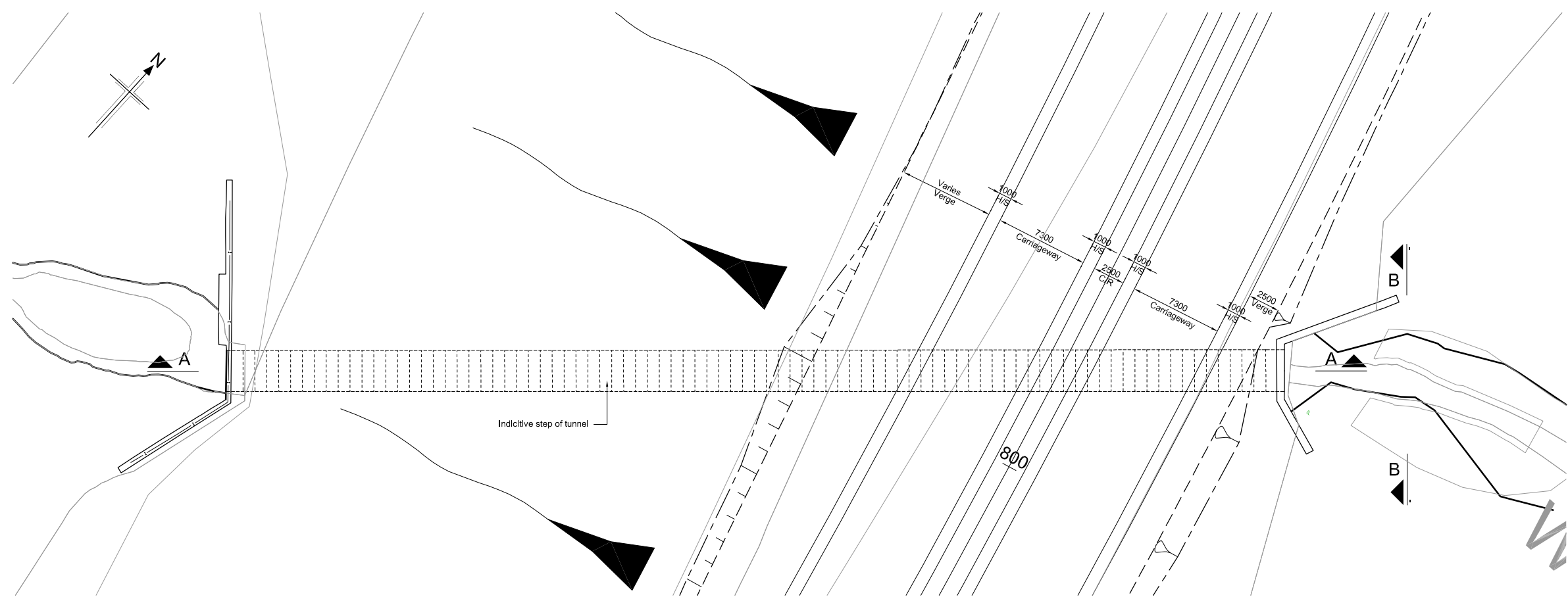

**PLAN**  
Scale 1:200

P2	11/05/17	DMRB Stage 3 Report - Draft	MG	IA	MAM	ELM
P1	07/10/16	Design Fix 3	MR	MAM	MAM	ELM
Rev	Rev. Date	Purpose of revision	Drawn	Checked	Rev'd	Appr'd

**JACOBS**  
95 Bothwell St, Glasgow, G2 7HX  
Tel: +44(0)141 243 8000 Fax: +44(0)141 226 3109  
www.jacobs.com



**KILLIECRANKIE TO GLEN GARRY  
EACHAINN BURN CULVERT  
GENERAL ARRANGEMENT**

Scale	AS SHOWN @ A1	DO NOT SCALE
Jacobs No.	B2140005	

Drawing number	Figure A.11.8.1	Rev	P2
----------------	-----------------	-----	----

This drawing is not to be used in whole or part other than for the intended purpose and project as defined on this drawing. Refer to the contract for full terms and conditions.



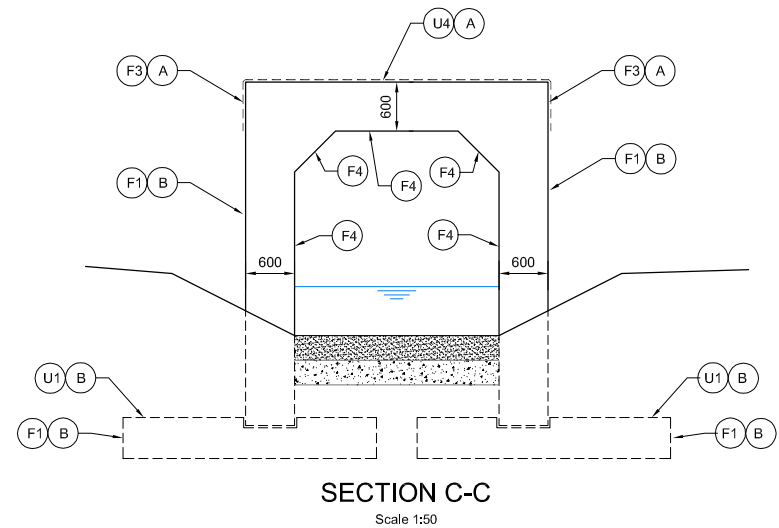

**SECTION C-C**  
Scale 1:50

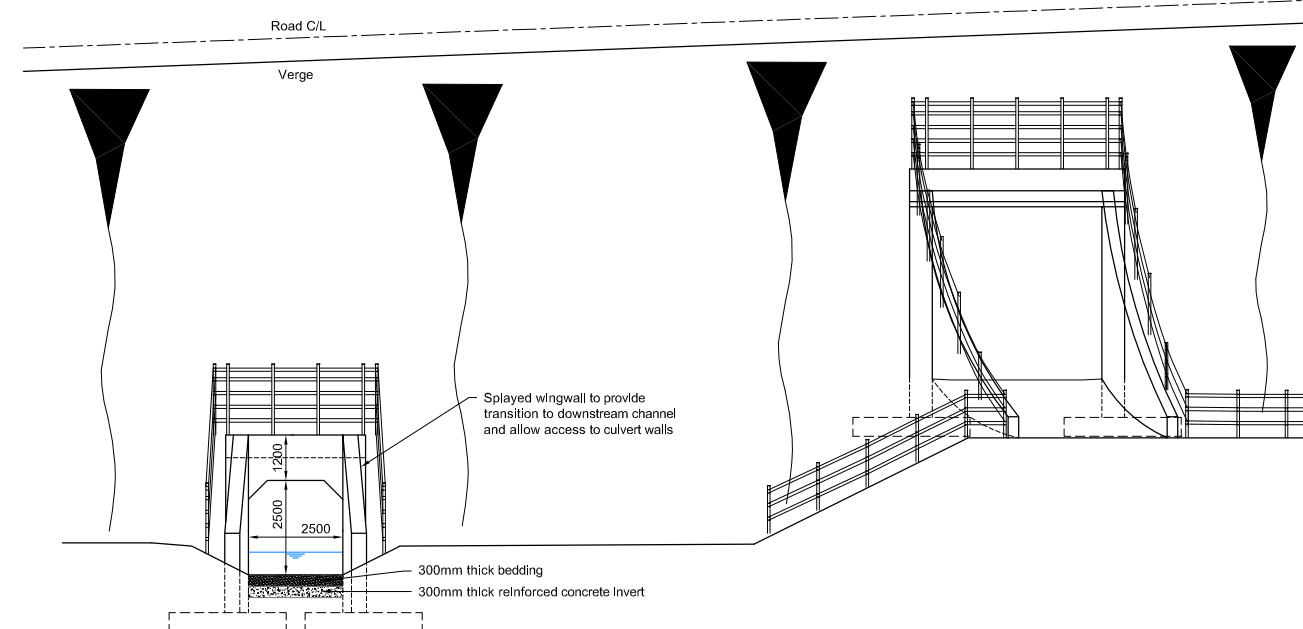

**ELEVATION A-A**  
Scale 1:100

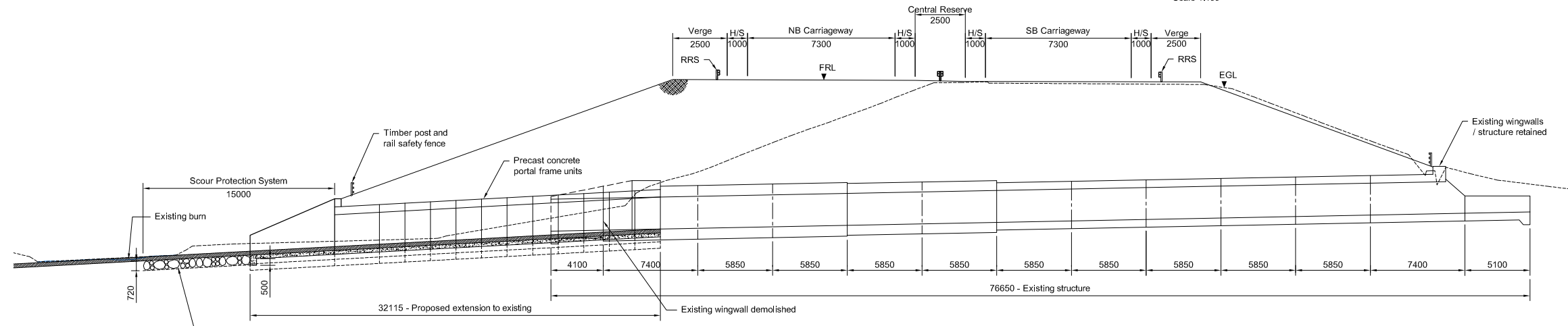

**SECTION B-B**  
Scale 1:200

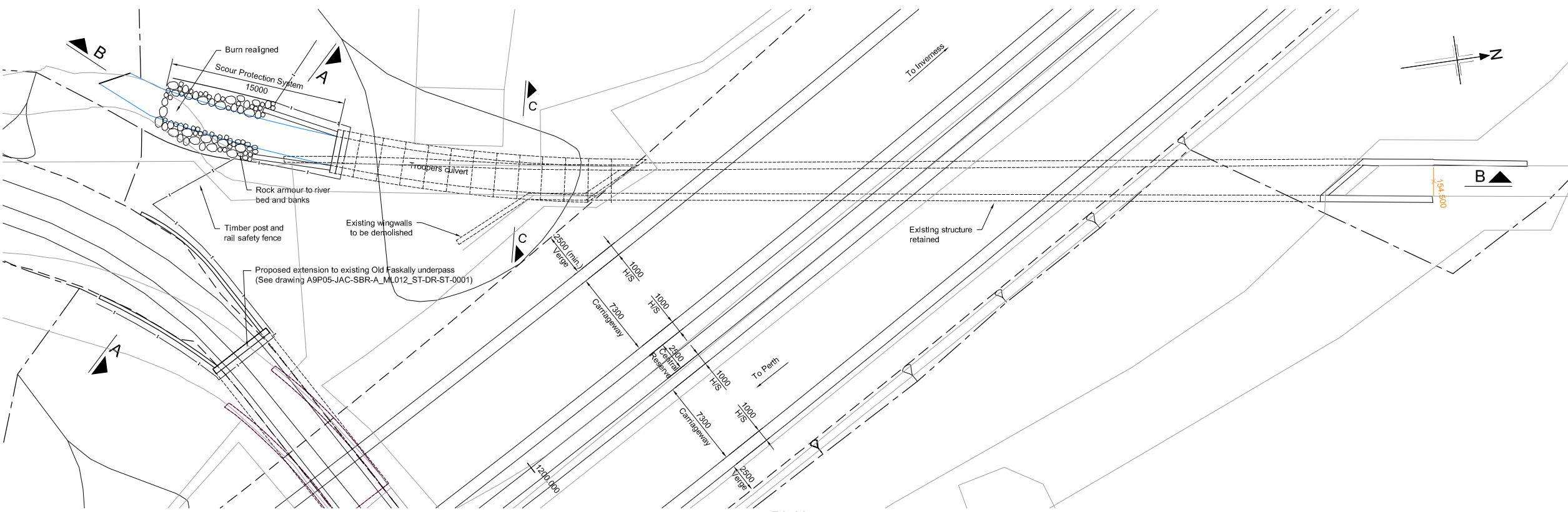

**PLAN**  
Scale 1:200

- Notes.
- All dimensions are in millimetres unless noted otherwise.
  - All levels are in metres Above Ordnance Datum.
  - All chainages are in metres.
  - All exposed arrises to have 25x25 chamfers unless noted otherwise.
  - Concrete finishes denoted thus:  
F - Formed  
U - Unformed
  - Concrete protection to be as follows:  
S - Surface impregnation in accordance with BD43 of the DMRB  
A - Spray applied waterproofing in accordance with CI 2003 of the Specification.  
B - Waterproofing of all buried concrete surfaces in accordance with CI 2004 of the Specification.
  - The downstream culvert outlet structure shall provide a minimum 500mm downstand at its leading edge and provision of a scour protection system extending 15m downstream. The design of the scour protection system shall be in accordance with DMRB. Rock armour shown has Dn50 0.36m and Wn50 125kg.
  - All details shown on this drawing are indicative only and subject to development.

SAFETY, HEALTH AND ENVIRONMENTAL INFORMATION	
In addition to the hazards/risks normally associated with the types of work detailed on this drawing, note the following:	
<b>CONSTRUCTION</b>	
<ul style="list-style-type: none"> <li>Service survey required pre-construction</li> <li>Potential presence in existing structure of harmful substances causing damage to health to be established pre-demolition</li> <li>Structure stability to be checked during break-out / demolition of existing structure</li> <li>Nature and position of the existing structure foundations to be verified pre-construction by underpinning investigations</li> <li>Condition of existing structure may not be as anticipated.</li> <li>Existing structure may not be accurately represented by record drawings.</li> <li>Position of existing structure may not be as shown</li> </ul>	
<b>MAINTENANCE / CLEANING</b>	
None	
<b>DECOMMISSIONING / DEMOLITION</b>	
None	
It is assumed that all works will be carried out by a competent contractor working, where appropriate, to an approved method statement	

Rev	Rev. Date	Purpose of revision	Drawn	Checked	Rev'd	App'd
P2	10/05/17	DMRB Stage 3 Report - Draft	MG	IA	MAM	ELM
P1	07/10/16	Design Fix 3	MR	MM	MM	ELM

**JACOBS**  
95 Bothwell St, Glasgow, G2 7HX  
Tel: +44(0)141 243 8000 Fax: +44(0)141 226 3109  
www.jacobs.com



**KILLIECRANKIE TO GLEN GARRY TROOPERS CULVERT GENERAL ARRANGEMENT**

Scale	AS SHOWN @ A1	DO NOT SCALE
Jacobs No.	B2140005	
Drawing number	Figure A.11.8.2	Rev
		P2

This drawing is not to be used in whole or part other than for the intended purpose and project as defined on this drawing. Refer to the contract for full terms and conditions.

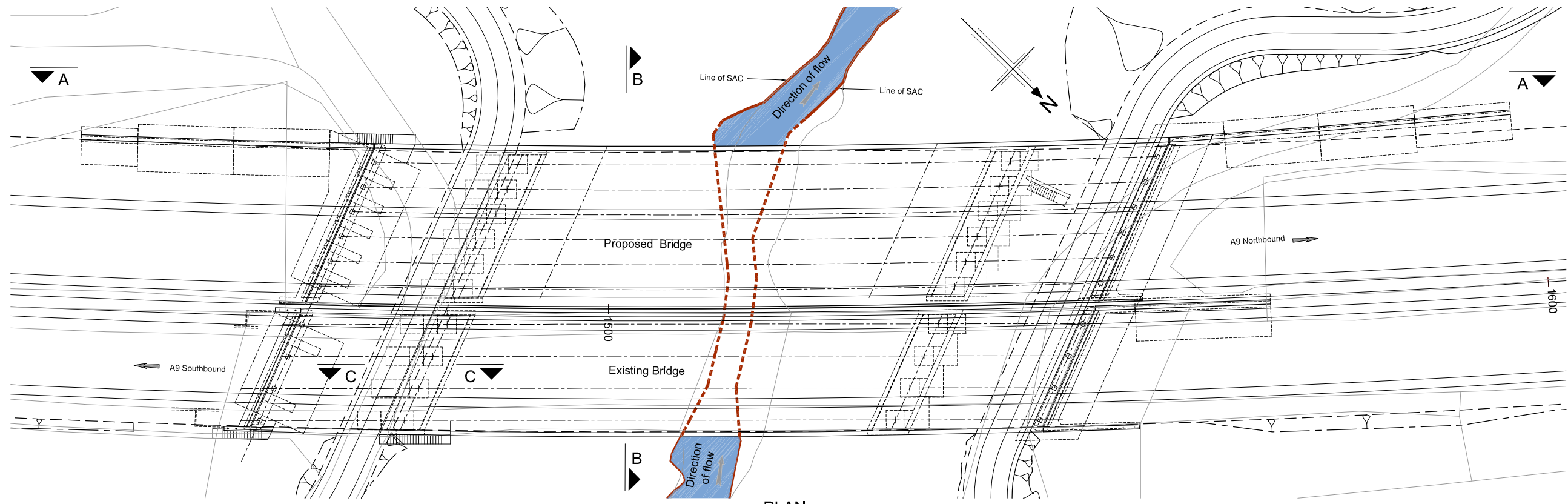

**PLAN**  
SCALE 1:250

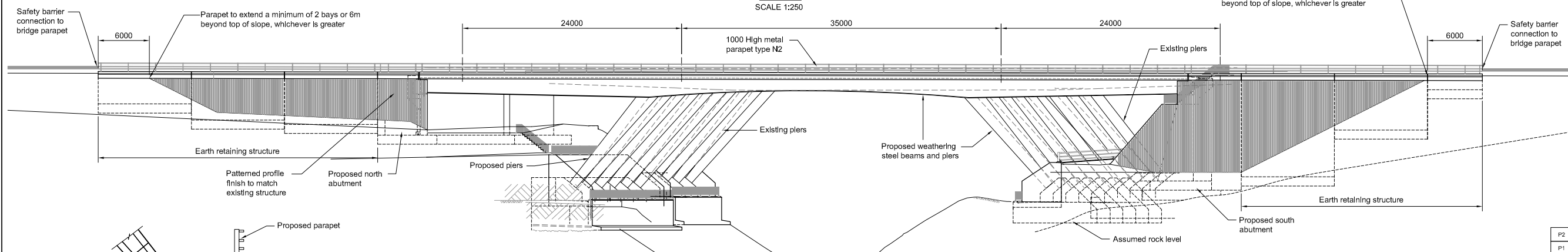

**ELEVATION A - A**  
SCALE 1:250

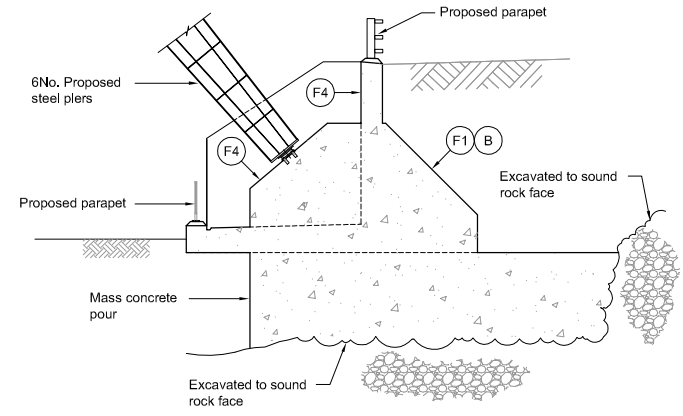

**SECTION C - C**  
TYPICAL PIER SUPPORT DETAIL  
SCALE 1:100

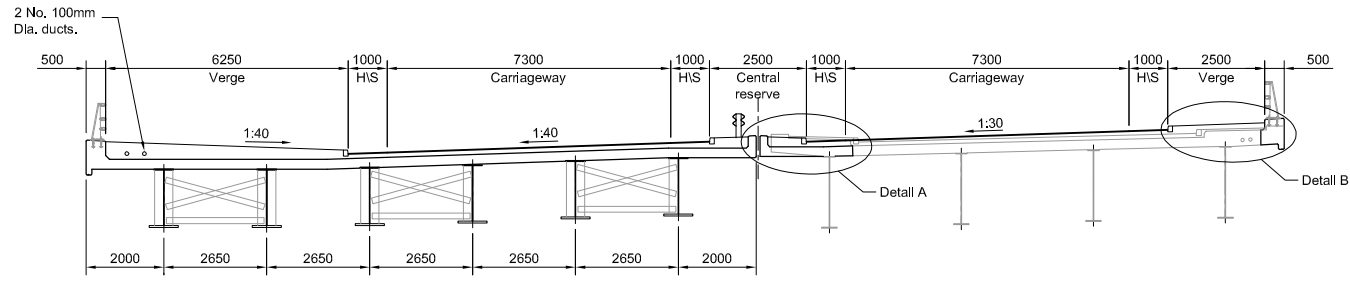

**SECTION B - B**  
SCALE 1:100

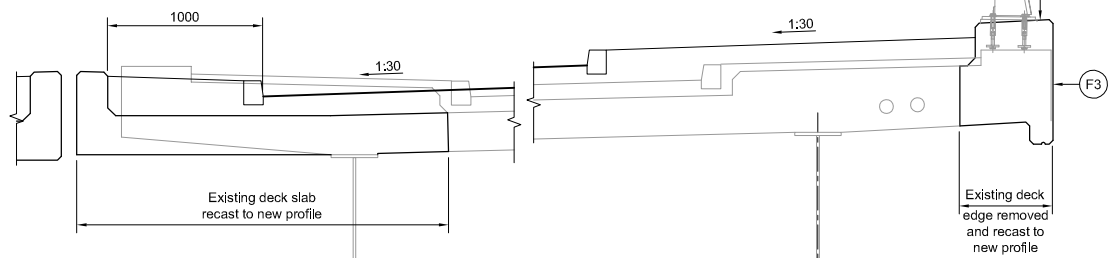

**DETAIL A**  
SCALE 1:25

**DETAIL B**  
SCALE 1:25

- Notes**
- All dimensions are in millimetres unless noted otherwise.
  - All levels in metres Above Ordnance Datum.
  - All chainages are in metres.
  - All exposed arrises to have 25x25 chamfers unless noted otherwise.
  - All details shown on this drawing are indicative only and subject to development.
  - Do not scale from this drawing.
  - Concrete finishes :
    - (F) - Formed surfaces.
    - (U) - Unformed surfaces.
  - Concrete protection :
    - (B) - Burred surfaces.
    - (W) - Spray applied waterproofing.

SAFETY, HEALTH AND ENVIRONMENTAL INFORMATION	
In addition to the hazards/tasks normally associated with the types of work detailed on this drawing, note the following :	
<b>CONSTRUCTION</b>	
<ul style="list-style-type: none"> <li>Service survey required pre-construction</li> <li>Potential presence in existing structure of harmful substances causing damage to health to be established before any remedial works are undertaken</li> <li>Structure stability to be checked during break-out of existing structure</li> <li>Nature and position of the existing structure foundations to be verified pre-construction by undertaking investigations</li> <li>Condition of existing structure may not be as anticipated.</li> <li>Existing structure may not be accurately represented by record drawings.</li> <li>Position of existing structure may not be as shown</li> </ul>	
<b>MAINTENANCE / CLEANING</b>	
- None	
<b>DECOMMISSIONING / DEMOLITION</b>	
- None	
It is assumed that all work will be carried out by a competent contractor working, where appropriate, to an approved method statement	

Reproduction from the Ordnance Survey Map with the permission of the controller of Her Majesty's stationery office Crown copyright reserved Licence No. 10001.9601.2008

P2	15/05/17	DMRB Stage 3 Report - Draft	MG	IA	MAM	ELM
P1	10/10/16	Design Fix 3	GPA	PG	MAM	ELM
Rev	Rev. Date	Purpose of revision	Drawn	Checked	Rev'd	Appr'd

**JACOBS**  
95 Bothwell St, Glasgow, G2 7HX  
Tel: +44(0)141 243 8000 Fax: +44(0)141 226 3109  
www.jacobs.com



**KILLECRANKIE TO GLEN GARRY ALLT GIRNAIG UNDERBRIDGE GENERAL ARRANGEMENT**

Drawing status		PRELIMINARY	
Scale	@ A1	DO NOT SCALE	
Jacobs No.	B2140005		
Drawing number	Figure A.11.8.3	Rev P2	

This drawing is not to be used in whole or part other than for the intended purpose and project as defined on this drawing. Refer to the contract for full terms and conditions.

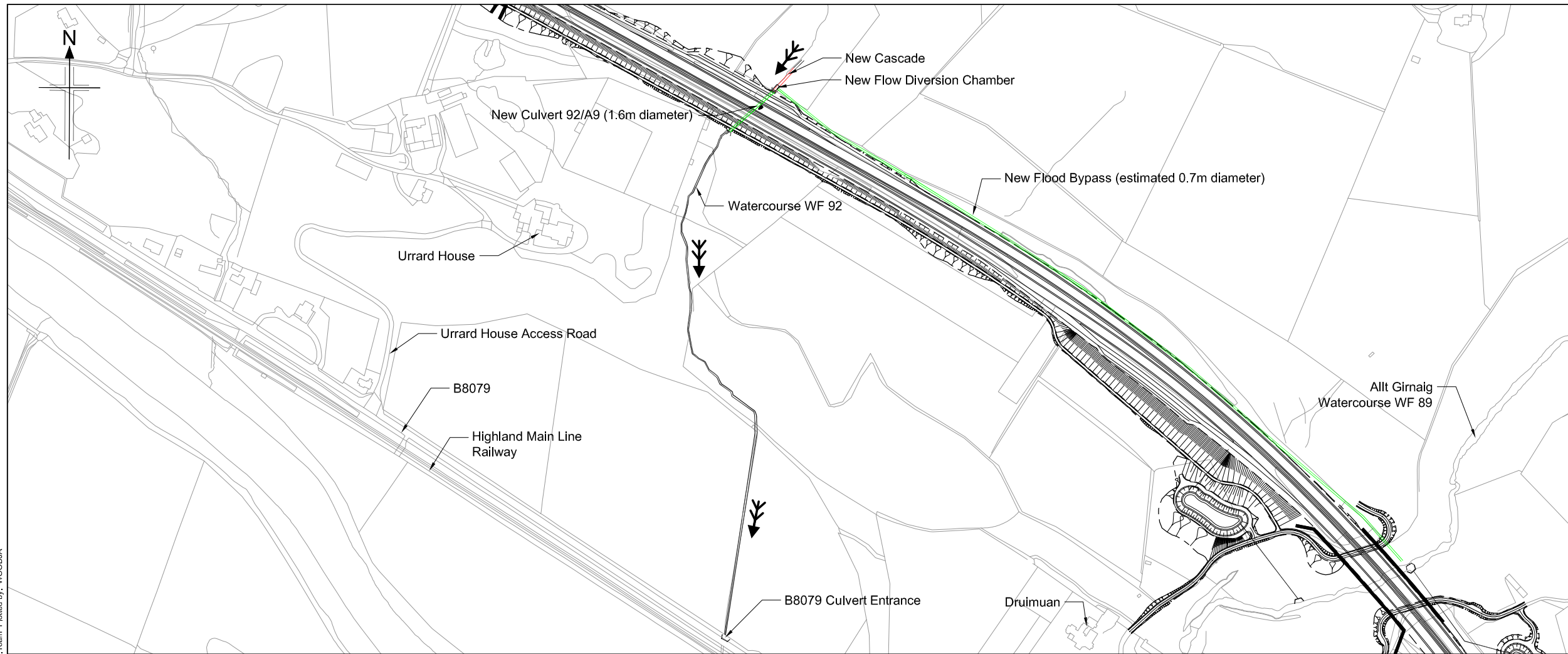

- Legend:
- New culvert/extension
  - - - Retained culvert
  - Realigned/regraded channel
  - Cascade
  - Inlet/outlet headwall (new)
  - - - Inlet/outlet headwall (retained)
  - Pre-earthworks drain and outfall
  - Access chamber
  - Flow direction
  - IL Invert Level

- Notes:
1. All dimensions are in meters unless noted otherwise.
  2. All levels are in meters above ordnance datum.
  3. All details shown on this drawing are indicative only and subject to development at detailed design.
  4. This drawing shall be read in conjunction with the 'Watercourse Crossing report' only and not in Isolation.
  5. All 'new' and 'extended' culverts have been designed in accordance with the relevant provisions of DMRB.
  6. Where required 'scour protection measures' shall be provided within the zone indicated on the drawing. The nature and the extent of the scour protection measure will be further developed at detailed design stage in accordance with the relevant provisions of DMRB, taking into account flow hydraulics, channel geometry and channel morphology.
  7. Where shown culverts shall be 'embedded' with natural river deposits to the depth shown.
  8. Where shown 'cascades' are required to safely convey the design flood event (0.5% AEP (200-year) plus allowance for climate change). The cascade geometry shown on the drawing is indicative only and will be subject to further development at detailed design stage. The nature of the cascade will take one of the following forms:
    - Bedrock channel cascade.
    - Natural cascade with natural gravels, cobbles and rock forming individual steps.
    - Concrete cascade with stone pitching.
 The nature of the cascade will be determined at the detailed design stage taking into account hydraulic requirements, topography and nature of the underlying strata and its susceptibility to fluvial erosion.
  9. Where shown mammal ledges will be provided within the culvert in accordance with the relevant provisions of DMRB.

SCHEMATIC PLAN

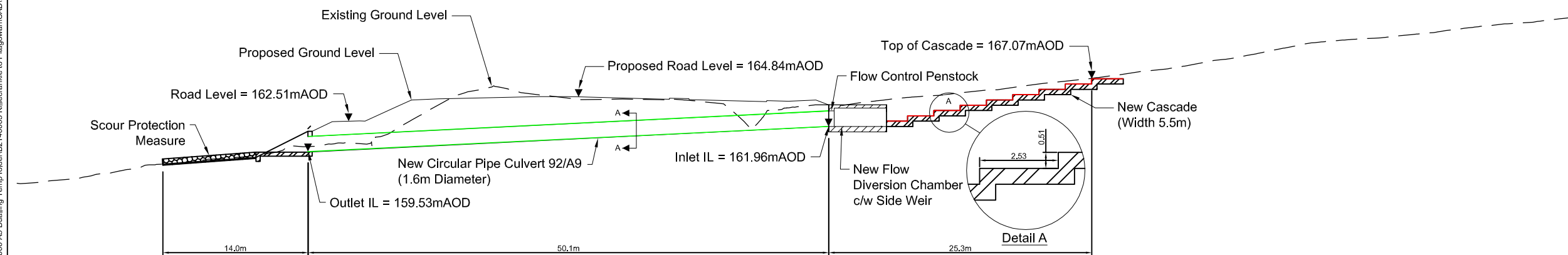
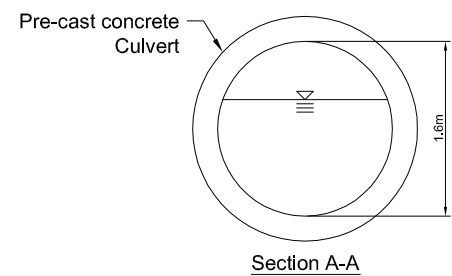

WATERCOURSE 92 LONGSECTION

Rev	Rev. Date	Purpose of revision	CON	JW	LMcG	Rev'd	Appr'd
0	31/10/17	FOR INFORMATION					



Drawing title  
**KILIECRANKIE TO GLEN GARRY PROPOSED MODIFICATIONS TO CULVERT ON WATERCOURSE WF92**

Drawing status  
**FOR INFORMATION**

Scale  
 NTS @ A1 DO NOT SCALE

Jacobs No.  
 B2140005

Drawing number  
**Figure A.11.8.4**

Rev  
**0**

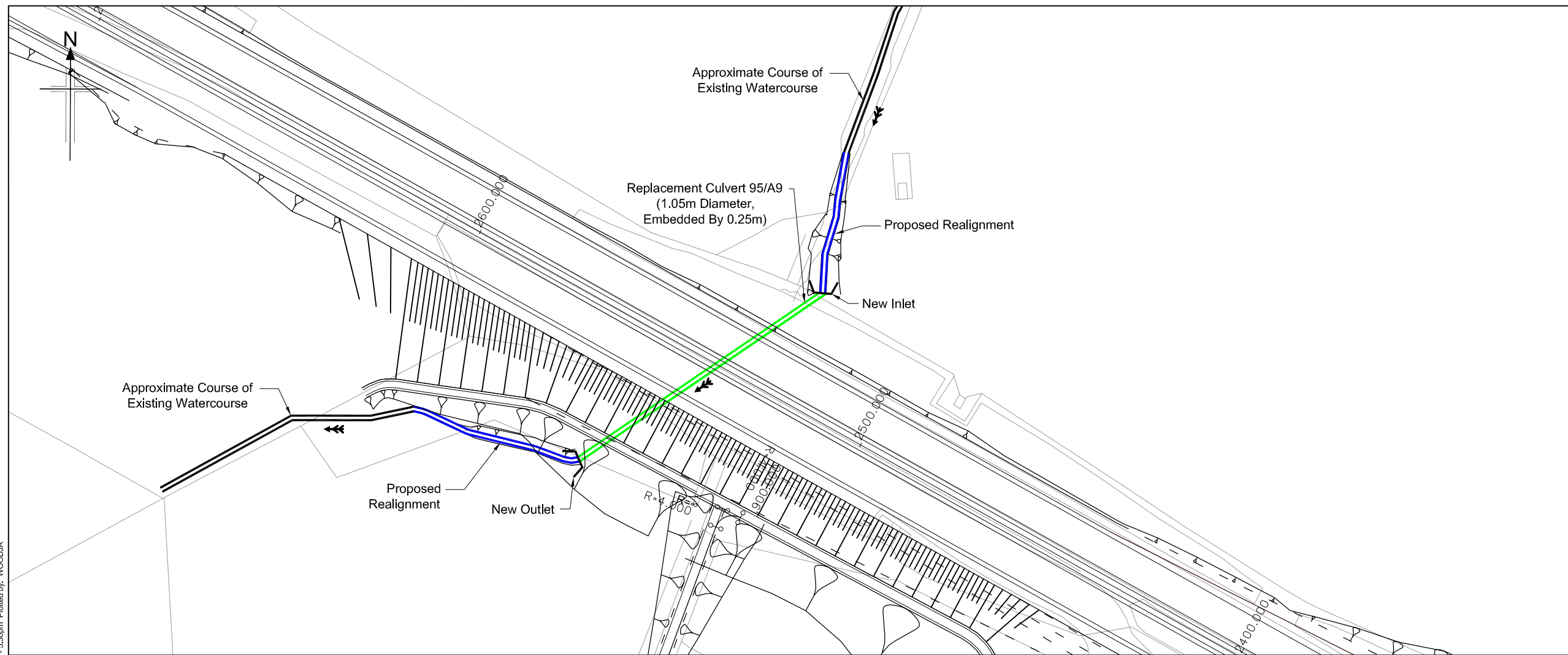

**SCHEMATIC PLAN**

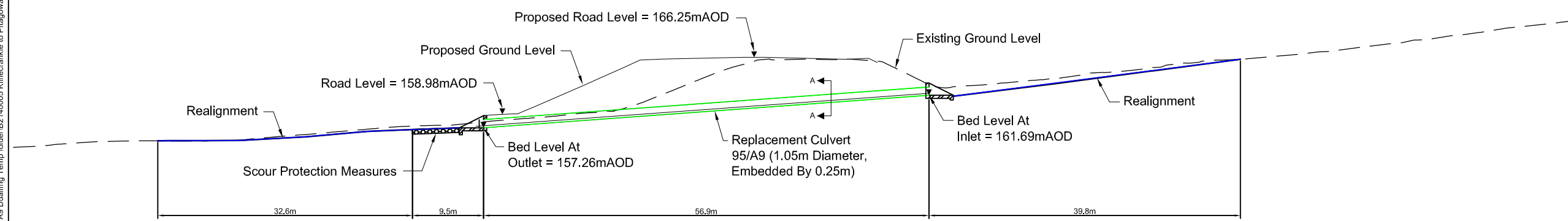
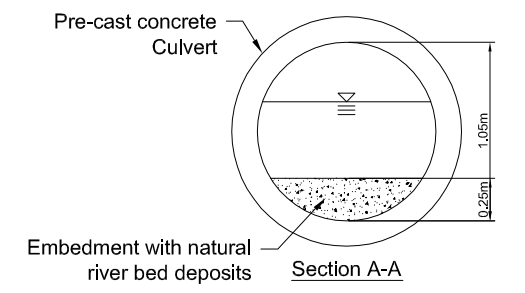

**WATERCOURSE 95 LONGSECTION**

**Legend:**

- New culvert/extension
- - - Retained culvert
- Realigned/regraded channel
- Cascade
- Inlet/outlet headwall (new)
- - - Inlet/outlet headwall (retained)
- Pre-earthworks drain and outfall
- Access chamber
- Flow direction
- IL Invert Level

- Notes:**
1. All dimensions are in meters unless noted otherwise.
  2. All levels are in meters above ordnance datum.
  3. All details shown on this drawing are indicative only and subject to development at detailed design.
  4. This drawing shall be read in conjunction with the 'Watercourse Crossing report' only and not in isolation.
  5. All 'new' and 'extended' culverts have been designed in accordance with the relevant provisions of DMRB.
  6. Where required 'scour protection measures' shall be provided within the zone indicated on the drawing. The nature and the extent of the scour protection measure will be further developed at detailed design stage in accordance with the relevant provisions of DMRB, taking into account flow hydraulics, channel geometry and channel morphology.
  7. Where shown culverts shall be 'embedded' with natural river deposits to the depth shown.
  8. Where shown 'cascades' are required to safely convey the design flood event (0.5% AEP (200-year) plus allowance for climate change). The cascade geometry shown on the drawing is indicative only and will be subject to further development at detailed design stage. The nature of the cascade will take one of the following forms,
    - Bedrock channel cascade.
    - Natural cascade with natural gravels, cobbles and rock forming individual steps.
    - Concrete cascade with stone pitching.
 The nature of the cascade will be determined at the detailed design stage taking into account hydraulic requirements, topography and nature of the underlying strata and its susceptibility to fluvial erosion.
  9. Where shown mammal ledges will be provided within the culvert in accordance with the relevant provisions of DMRB.

Rev	Rev. Date	Purpose of revision	Drawn	Checked	Rev'd	Apprv'd
0	10/01/17	FOR INFORMATION				



95 Bothwell St, Glasgow, G2 7HX  
Tel: +44(0)141 243 9000 Fax: +44(0)141 226 3109  
www.jacobs.com



**Drawing title**  
 KILLIECRANKIE TO GLEN GARRY  
 PROPOSED MODIFICATIONS  
 TO CULVERT ON  
 WATERCOURSE WF95

**Drawing status**  
 FOR INFORMATION

Scale	NTS @ A1	DO NOT SCALE
Jacobs No.	B2140005	

**Drawing number**  
 Figure A.11.8.5

**Rev**  
 0

Reproduced by permission of Ordnance Survey on behalf of HMSO.  
 © Crown copyright and database right 2017. All rights reserved.  
 Ordnance Survey Licence number 100046668.

© Copyright 2017 Jacobs U.K. Limited. The concepts and information contained in this document are the property of Jacobs. Use or copying of this document in whole or in part without the written permission of Jacobs constitutes an infringement of copyright. Limitation: This drawing has been prepared on behalf of, and for the exclusive use of, Jacobs Client, and is subject to, and limited in accordance with, the provisions of the contract between Jacobs and the Client. Jacobs accepts no liability or responsibility whatsoever for, or in respect of, any use of, or reliance upon, this drawing by any third party.

File: I:\Glarif\07\PV01\ECBC\BWA\_Joos\B2140005 A9 Dualing Temp folder\B2140005 Killiecrankie to Pitegowan\CAD\Watercourse Modifications\WF95.dwg Date: Aug 02, 2017 - 5:30pm Plotted by: WOODJIA

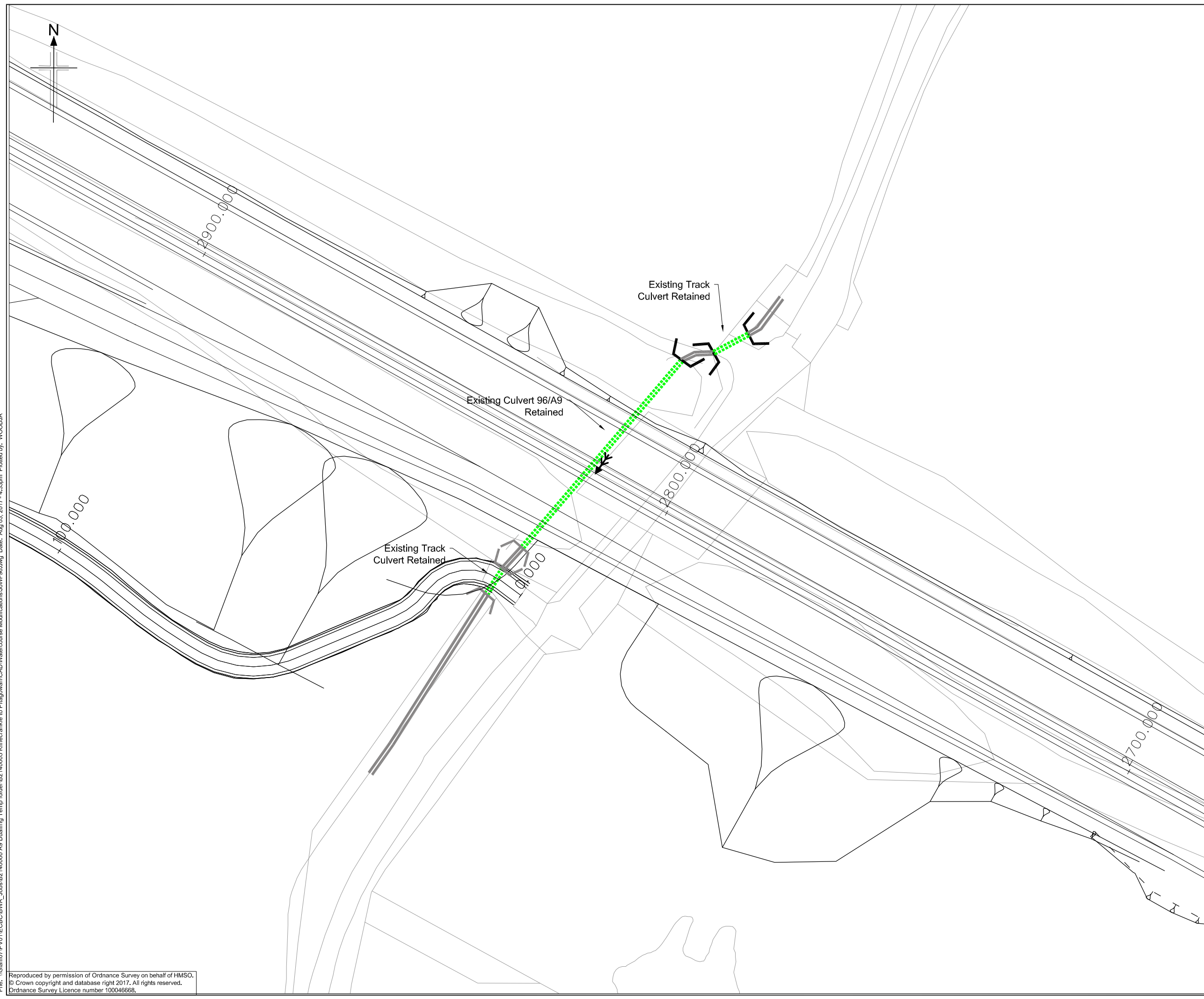

- Legend:**
- New culvert/extension
  - - - Retained culvert
  - Realigned/regraded channel
  - Cascade
  - Inlet/outlet headwall (new)
  - - - Inlet/outlet headwall (retained)
  - Pre-earthworks drain and outfall
  - Access chamber
  - ← Flow direction
  - IL Invert Level

- Notes:**
1. All dimensions are in meters unless noted otherwise.
  2. All levels are in meters above ordnance datum.
  3. All details shown on this drawing are indicative only and subject to development at detailed design.
  4. This drawing shall be read in conjunction with the 'Watercourse Crossing report' only and not in isolation.
  5. All 'new' and 'extended' culverts have been designed in accordance with the relevant provisions of DMRB.
  6. Where required 'scour protection measures' shall be provided within the zone indicated on the drawing. The nature and the extent of the scour protection measure will be further developed at detailed design stage in accordance with the relevant provisions of DMRB, taking into account flow hydraulics, channel geometry and channel morphology.
  7. Where shown culverts shall be 'embedded' with natural river deposits to the depth shown.
  8. Where shown 'cascades' are required to safely convey the design flood event (0.5% AEP (200-year) plus allowance for climate change). The cascade geometry shown on the drawing is indicative only and will be subject to further development at detailed design stage. The nature of the cascade will take one of the following forms,
    - Bedrock channel cascade.
    - Natural cascade with natural gravels, cobbles and rock forming individual steps.
    - Concrete cascade with stone pitching.
 The nature of the cascade will be determined at the detailed design stage taking into account hydraulic requirements, topography and nature of the underlying strata and its susceptibility to fluvial erosion.
  9. Where shown mammal ledges will be provided within the culvert in accordance with the relevant provisions of DMRB.

D	10/01/17	FOR INFORMATION	CON			
Rev	Rev. Date	Purpose of revision	Drawn	Checked	Rev'd	Apprv'd

**JACOBS**  
 95 Bothwell St, Glasgow, G2 7HX  
 Tel: +44(0)141 243 9000 Fax: +44(0)141 226 3109  
 www.jacobs.com



**KILLIECRANKIE TO GLEN GARRY  
 PROPOSED MODIFICATIONS  
 TO CULVERT ON  
 WATERCOURSE WF96**

Drawing status: **FOR INFORMATION**

Scale	NTS @ A1	DO NOT SCALE
Jacobs No.	B2140005	

Drawing number: **Figure A.11.8.6** Rev: **0**

Reproduced by permission of Ordnance Survey on behalf of HMSO.  
 © Crown copyright and database right 2017. All rights reserved.  
 Ordnance Survey Licence number 100046668.

© Copyright 2017 Jacobs U.K. Limited. The concepts and information contained in this document are the property of Jacobs. Use or copying of this document in whole or in part without the written permission of Jacobs constitutes an infringement of copyright. Limitation: This drawing has been prepared on behalf of, and for the exclusive use of, Jacobs Client, and is subject to, and issued in accordance with, the provisions of the contract between Jacobs and the Client. Jacobs accepts no liability or responsibility whatsoever for, or in respect of, any use of, or reliance upon, this drawing by any third party.

File: I:\Glarif\07\PV01\ECBC\BWA\_Jobs\B2140005 A9 Dualling Temp folder\B2140005 A9 Dualling CAD\Watercourse Modifications\WF96.dwg Date: Aug 03, 2017 - 4:33pm Plotted by: WOODJIA

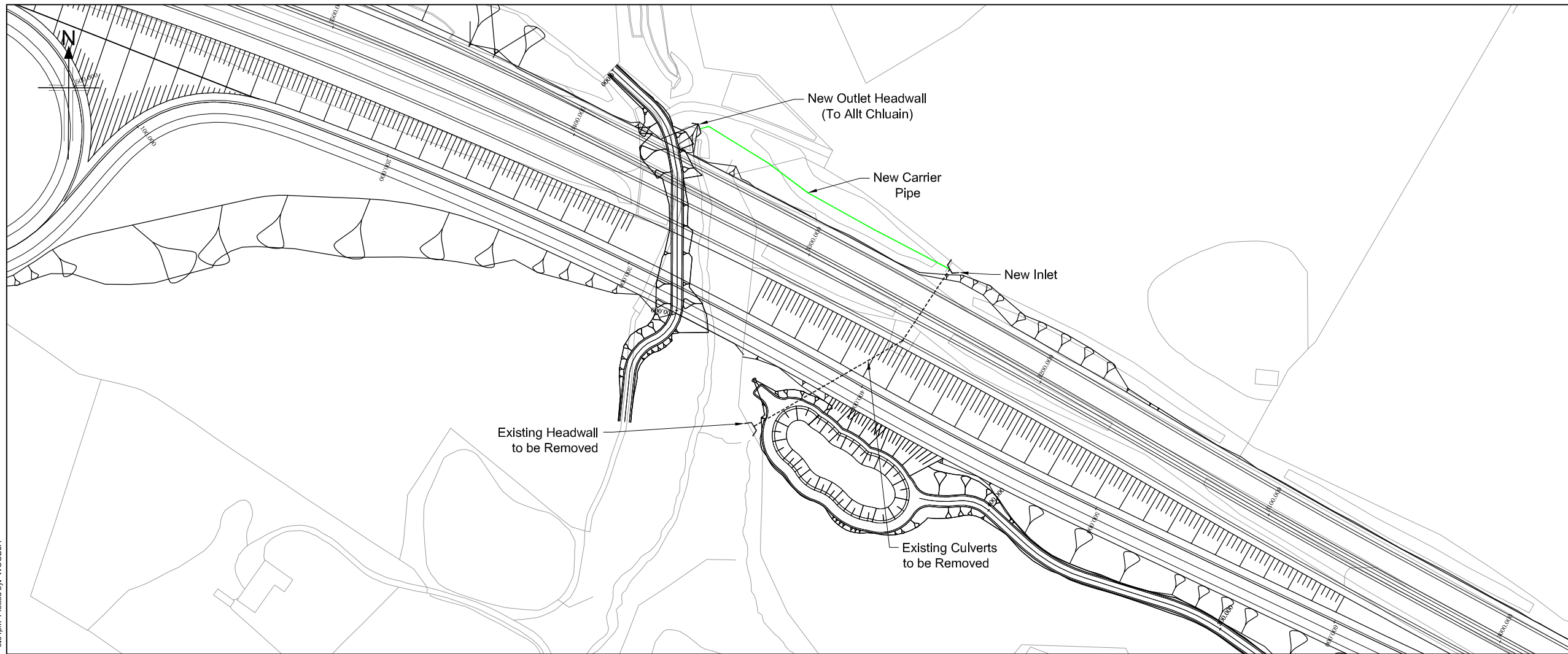

PLAN

- Legend:
- New culvert/extension
  - - - Retained culvert
  - Realigned/regraded channel
  - Cascade
  - Inlet/outlet headwall (new)
  - - - Inlet/outlet headwall (retained)
  - Pre-earthworks drain and outfall
  - Access chamber
  - - - Culvert to be removed

- Notes:
1. All dimensions are in meters unless noted otherwise.
  2. All details shown on this drawing are indicative only and subject to development at Detailed Design Stage.

I:\Glarif\07\PV01\ECBC\BWA\_Joos\B2140000 A9 Dualling Temp folder\B2140000 A9 Dualling CAD\Watercourse Modifications\WF97.dwg Date: Aug 02, 2017 - 5:34pm Plotted by: WOODJIA

Rev	Rev. Date	Purpose of revision	Drawn	Checked	Rev'd	Appr'd
0	10/01/17	FOR INFORMATION				



Drawing title

**KILLIECRANKIE TO GLEN GARRY  
PROPOSED MODIFICATIONS  
TO CULVERT ON  
WATERCOURSE WF97**

Drawing status

**FOR INFORMATION**

Scale: NTS @ A1 | DO NOT SCALE

Jacobs No. B2140005

Drawing number: **Figure A.11.8.7** | Rev: **0**

Reproduced by permission of Ordnance Survey on behalf of HMSO.  
© Crown copyright and database right 2017. All rights reserved.  
Ordnance Survey Licence number 100046668.

© Copyright 2017 Jacobs U.K. Limited. The concepts and information contained in this document are the property of Jacobs. Use or copying of this document in whole or in part without the written permission of Jacobs constitutes an infringement of copyright. Limitation: This drawing has been prepared on behalf of, and for the exclusive use of, Jacobs Client, and is subject to, and issued in accordance with, the provisions of the contract between Jacobs and the Client. Jacobs accepts no liability or responsibility whatsoever for, or in respect of, any use of, or reliance upon, this drawing by any third party.

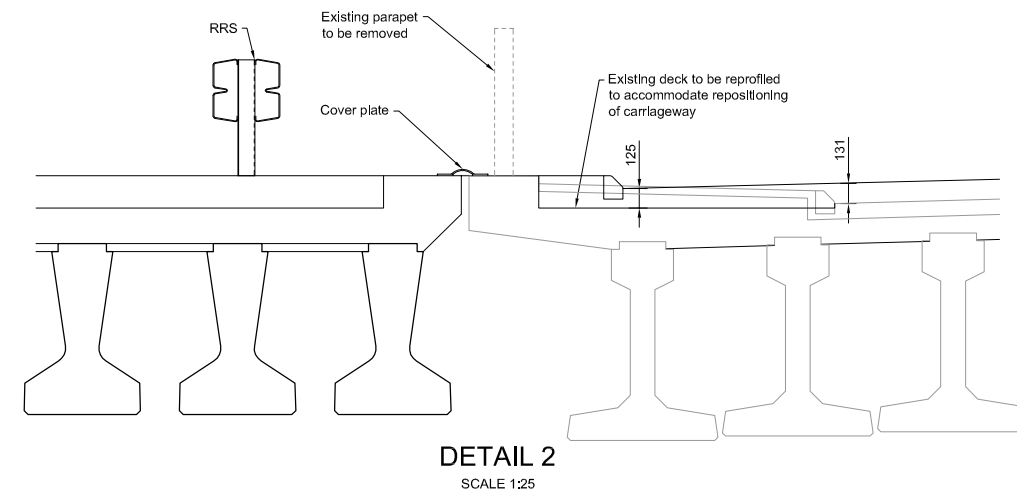
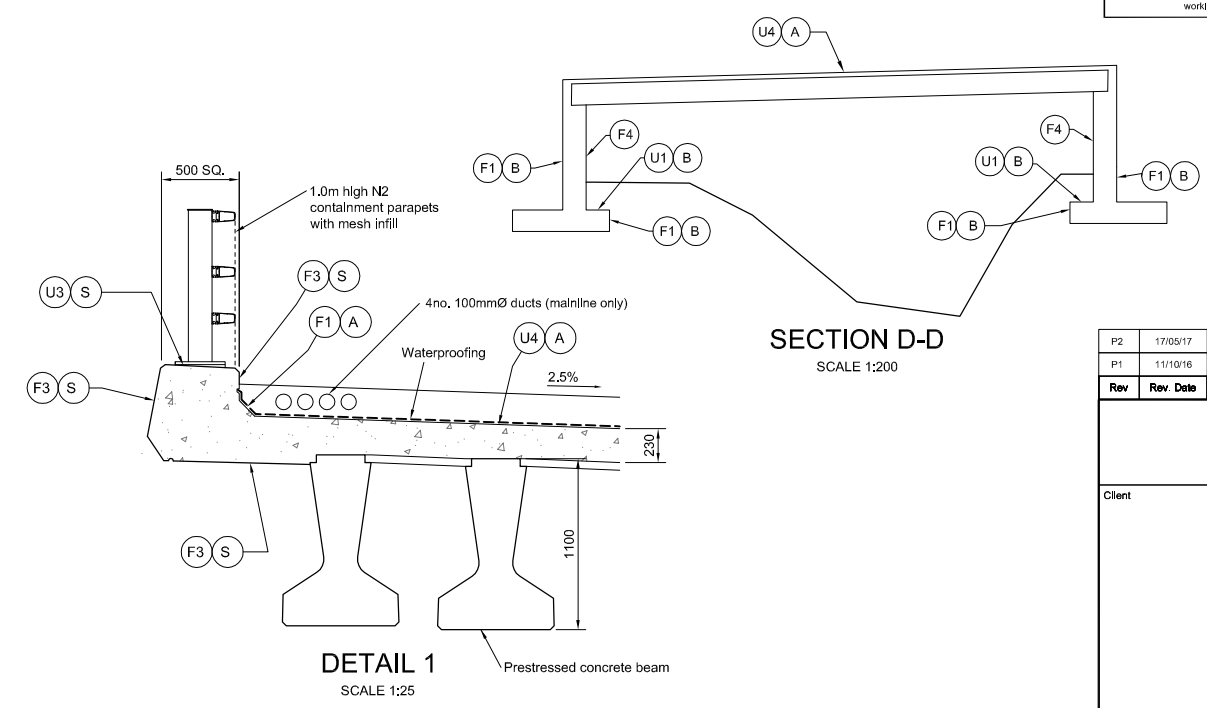
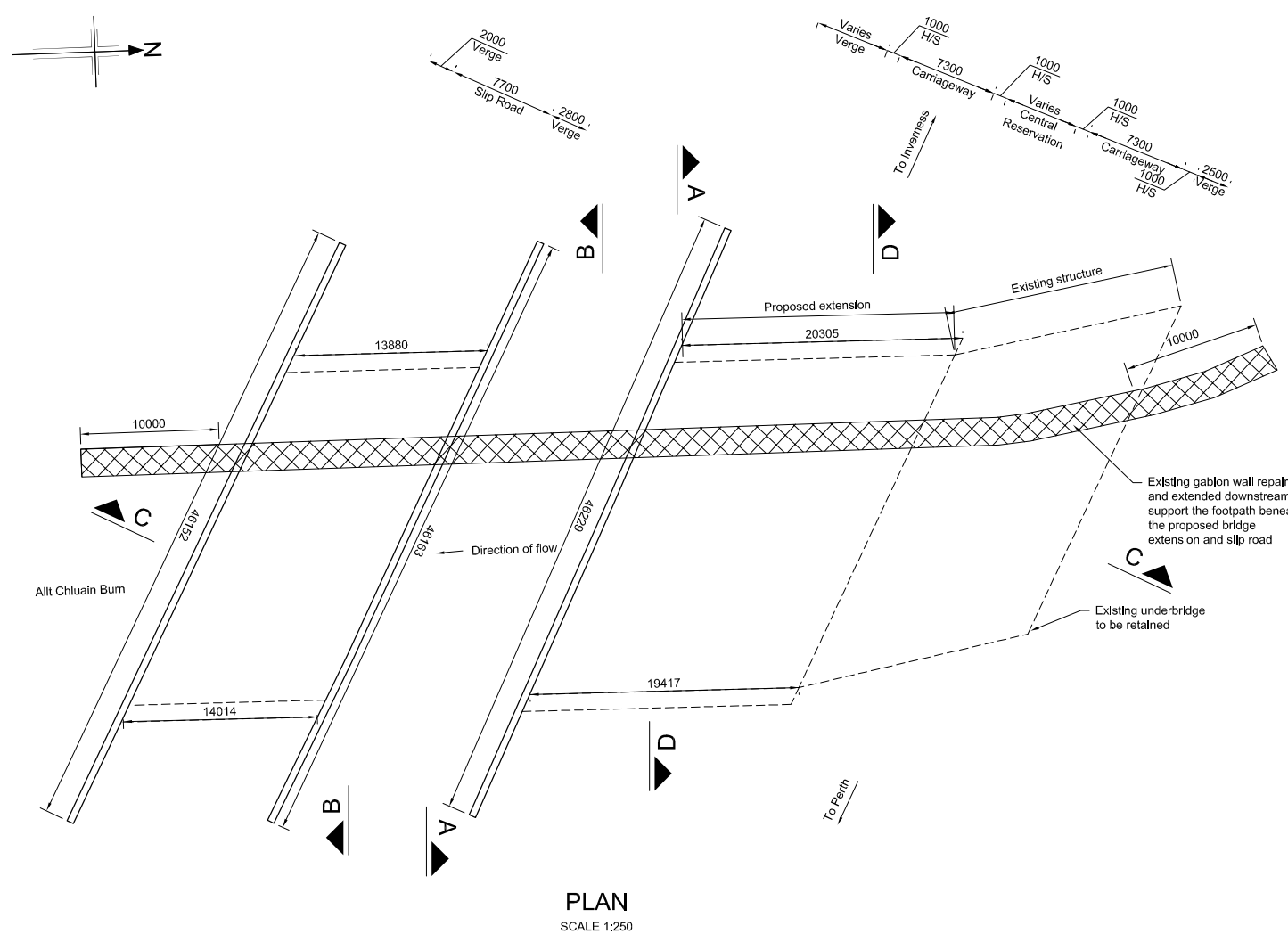
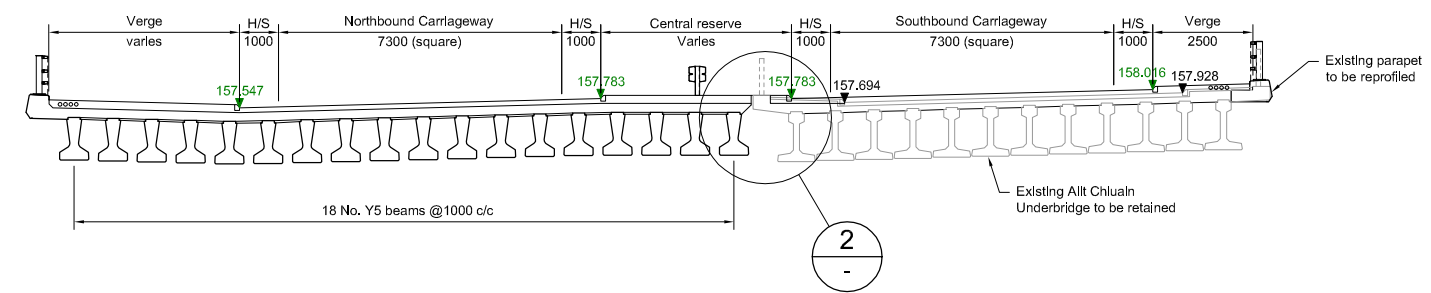
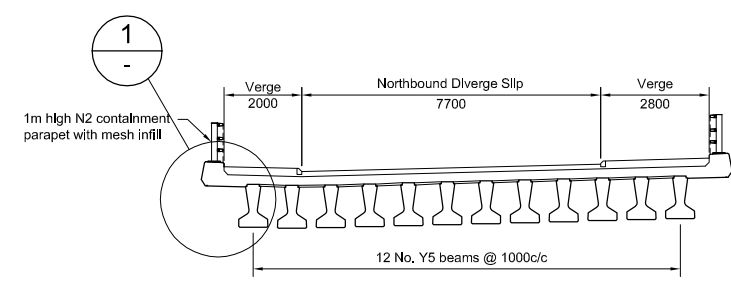
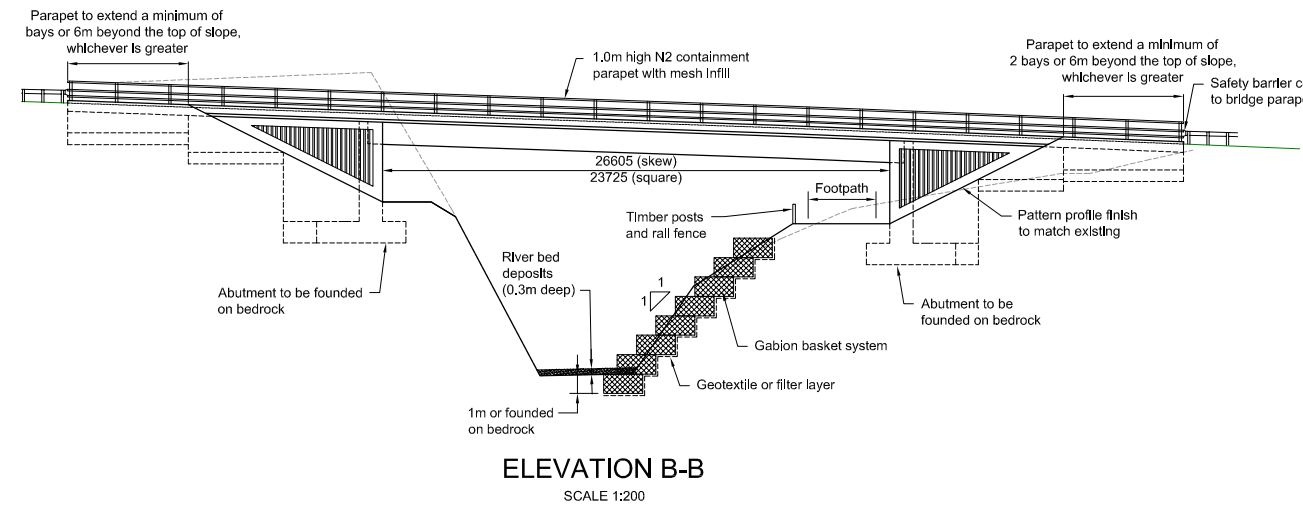
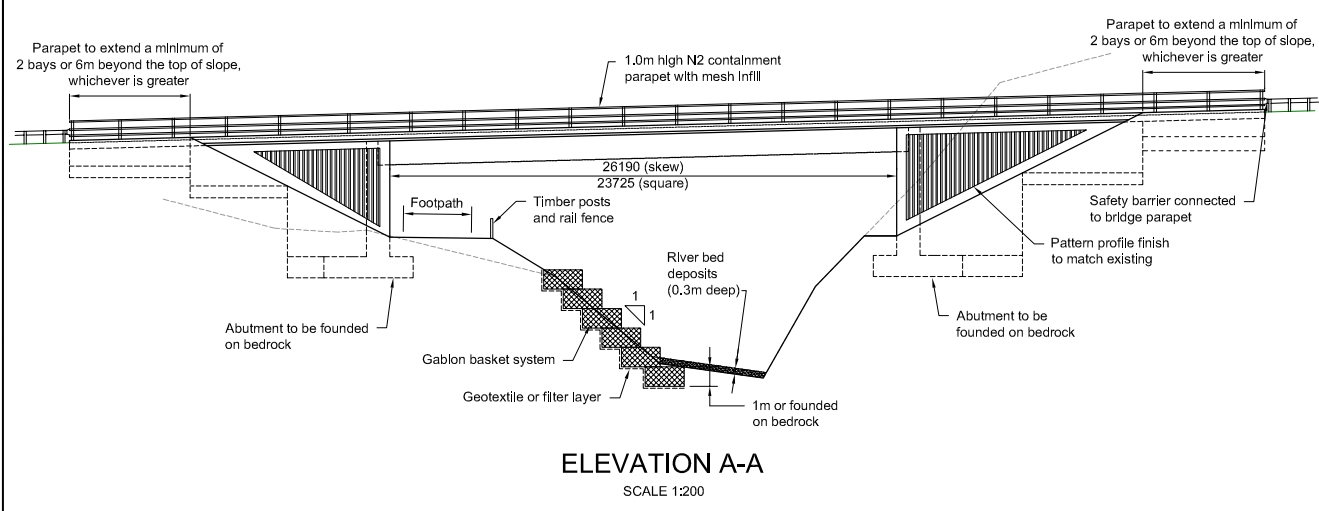

- Notes.
- All dimensions are in millimetres unless noted otherwise.
  - All levels are in metres Above Ordnance Datum.
  - All chainages are in metres.
  - All exposed arrises to have 25x25 chamfers unless noted otherwise.
  - Concrete finishes denoted thus:  
 (F) - Formed  
 (U) - Unformed
  - Concrete protection to be as follows:  
 (S) - Surface Impregnation in accordance with CI 1709 of the Specification.  
 (A) - Spray applied waterproofing in accordance with CI 2003 of the Specification.  
 (B) - Waterproofing of all buried concrete surfaces in accordance with CI 2004 of the Specification.
  - All details shown on this drawing are indicative only and subject to development.
  - Where required the existing gabion wall system shall be either repaired or replaced along the existing alignment and extended downstream to support/protect the proposed footpath. The nature and extent of the gabion wall system will be further developed at detail design stage in accordance with DMRB.

SAFETY, HEALTH AND ENVIRONMENTAL INFORMATION	
In addition to the hazards/risks normally associated with the types of work detailed on this drawing, note the following:	
<b>CONSTRUCTION</b>	
Service survey required pre-construction Potential presence in existing structure of harmful substances causing damage to health to be established pre-alteration Structure stability to be checked during break-out / demolition of existing structure Nature and position of the existing structure foundations to be verified pre-construction by undertaking investigations Condition of existing structure may not be as anticipated Existing structure may not be accurately represented by record drawings. Position of existing structure may not be as shown	
<b>MAINTENANCE / CLEANING</b>	
None	
<b>DECOMMISSIONING / DEMOLITION</b>	
None	
It is assumed that all works will be carried out by a competent contractor working, where appropriate, to an approved method statement	

Rev	Rev. Date	Purpose of revision	Drawn	Checked	Rev'd	App'd
P2	17/05/17	DMRB Stage 3 Report - Draft	MG	IA	MAM	ELM
P1	11/10/16	Design Flt 4 - Issued for Review	MR	MM	MM	ELM

**JACOBS**  
95 Bothwell St, Glasgow, G2 7HX  
Tel: +44(0)141 243 8000 Fax: +44(0)141 228 3109  
www.jacobs.com



**KILLIECRANKIE TO GLEN GARRY  
ALLT CHLUAIN UNDERBRIDGE  
GENERAL ARRANGEMENT**

Drawing status	
Scale	AS SHOWN @ A1 DO NOT SCALE
Jacobs No.	B2140005
Drawing number	Figure A.11.8.8
Rev	P2

This drawing is not to be used in whole or part other than for the intended purpose and project as defined on this drawing. Refer to the contract for full terms and conditions.

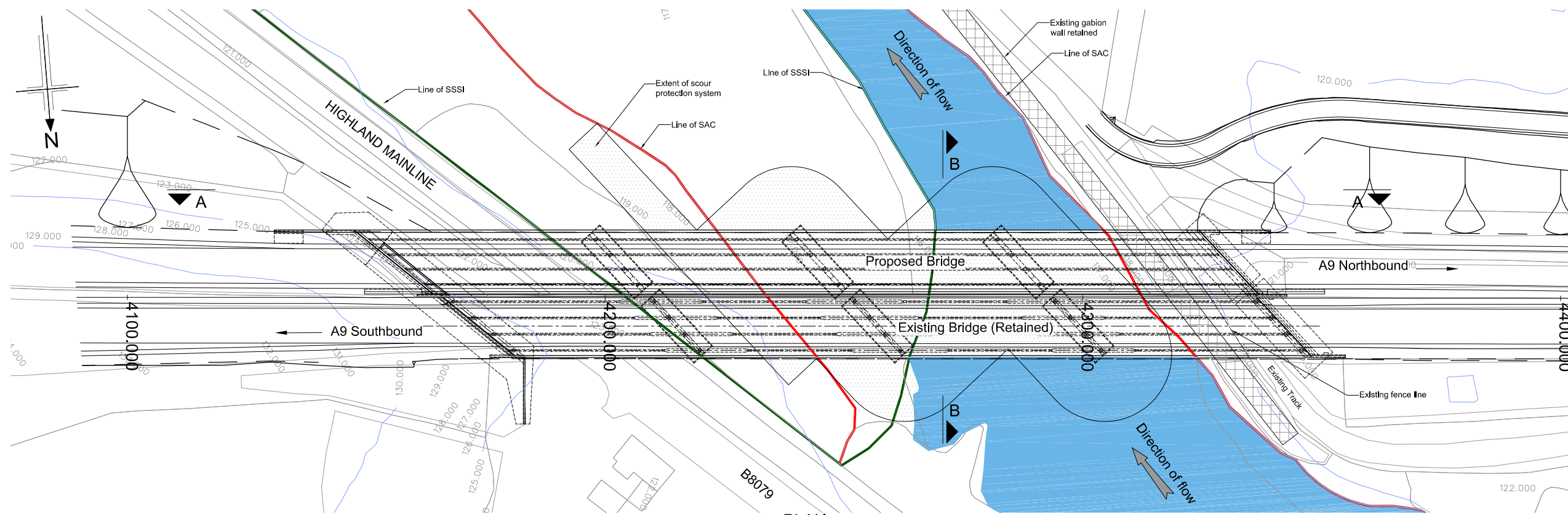

**PLAN**  
SCALE 1 : 500

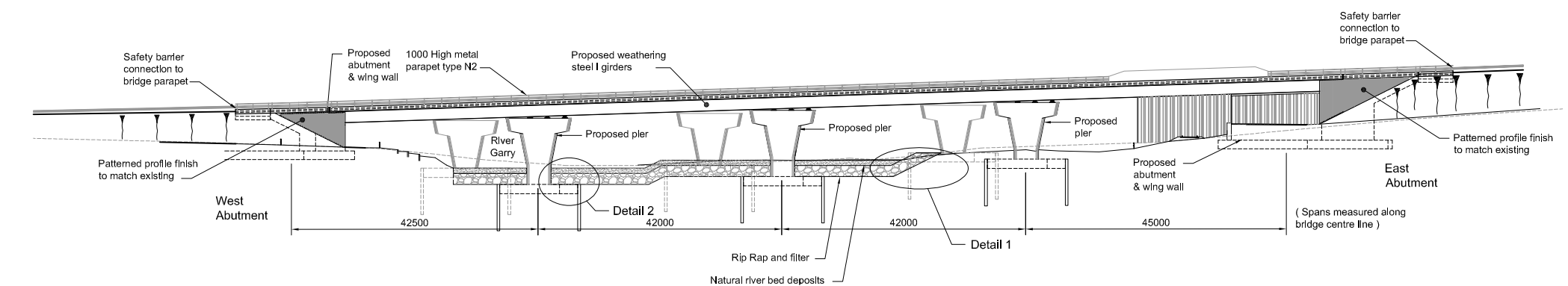

**ELEVATION A - A**  
SCALE 1 : 500

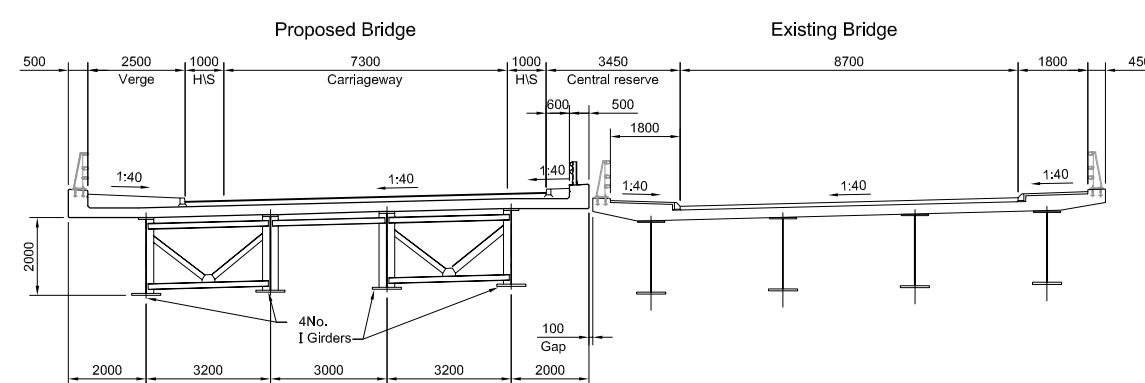

**SECTION B - B**  
(Existing deck untouched)  
SCALE 1 : 100

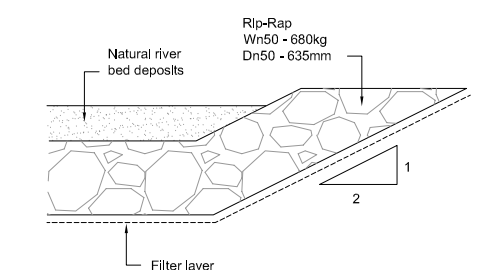

**DETAIL 1**  
SCALE 1 : 100

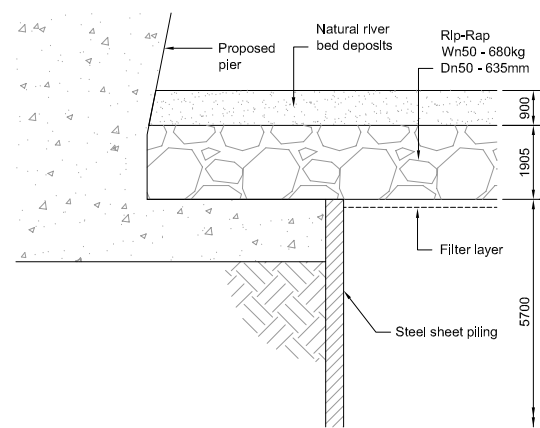

**DETAIL 2**  
SCALE 1 : 100

- Notes**
- All dimensions are in millimetres unless noted otherwise.
  - All levels in metres Above Ordnance Datum.
  - All chainages are in metres.
  - All exposed arrises to have 25x25 chamfers unless noted otherwise.
  - All details shown on this drawing are indicative only and subject to development.
  - Do not scale from this drawing.
  - Concrete finishes :  
 (F) - Formed surfaces,  
 (U) - Unformed surfaces.
  - Concrete protection :  
 (B) - Burled surfaces,  
 (W) - Spray applied waterproofing,  
 (S) - Surface Impregnation
  - Where required a scour protection system shall be provided within the zone indicated on this drawing. The nature and extent of the scour protection system will be further developed at detail design stage in accordance with DMRB, but may consist of a rock armour system as shown on this drawing.
  - Bedrock had been observed local to the bridge. Where sound bedrock exists within the scour protection zone and at a level conflicting with the proposed scour protection system, an appropriate detail will be designed to terminate the scour protection system.
  - The existing gabion mattress system surrounding the existing bridge foundations will be removed and replaced with the proposed scour protection system.

SAFETY, HEALTH AND ENVIRONMENTAL INFORMATION	
In addition to the hazards/risks normally associated with the types of work detailed on this drawing, note the following :	
<b>CONSTRUCTION</b> - Temporary longitudinal fixity to be provided to deck steelwork at both abutments during deck concreting.	
<b>MAINTENANCE / CLEANING</b> - None	
<b>DECOMMISSIONING / DEMOLITION</b> - None	
It is assumed that all works will be carried out by a competent contractor working, where appropriate, to an approved method statement	

Reproduction from the Ordnance Survey Map with the permission of the controller of Her Majesty's stationery office Crown copyright reserved Licence No. 10001.9601.2008

Rev	Rev. Date	Purpose of revision	Drawn	Checked	Rev'd	Apprv'd
P1	16/05/17	DMRB Stage 3 Report - Draft	MG	JA	MAM	ELM

**JACOBS**  
95 Bothwell St, Glasgow, G2 7HX  
Tel:+44(0)141 243 8000 Fax:+44(0)141 226 3109  
www.jacobs.com



**KILLIECRANKIE TO PITAGOWAN  
ESSANGAL UNDERBRIDGE  
GENERAL ARRANGEMENT**

Drawing status: **PRELIMINARY**

Scale: AS SHOWN @ A1 DO NOT SCALE

Drawing number: **Figure A.11.8.9(a)** Rev: P1

This drawing is not to be used in whole or part other than for the intended purpose and project as defined on this drawing. Refer to the contract for full terms and conditions.



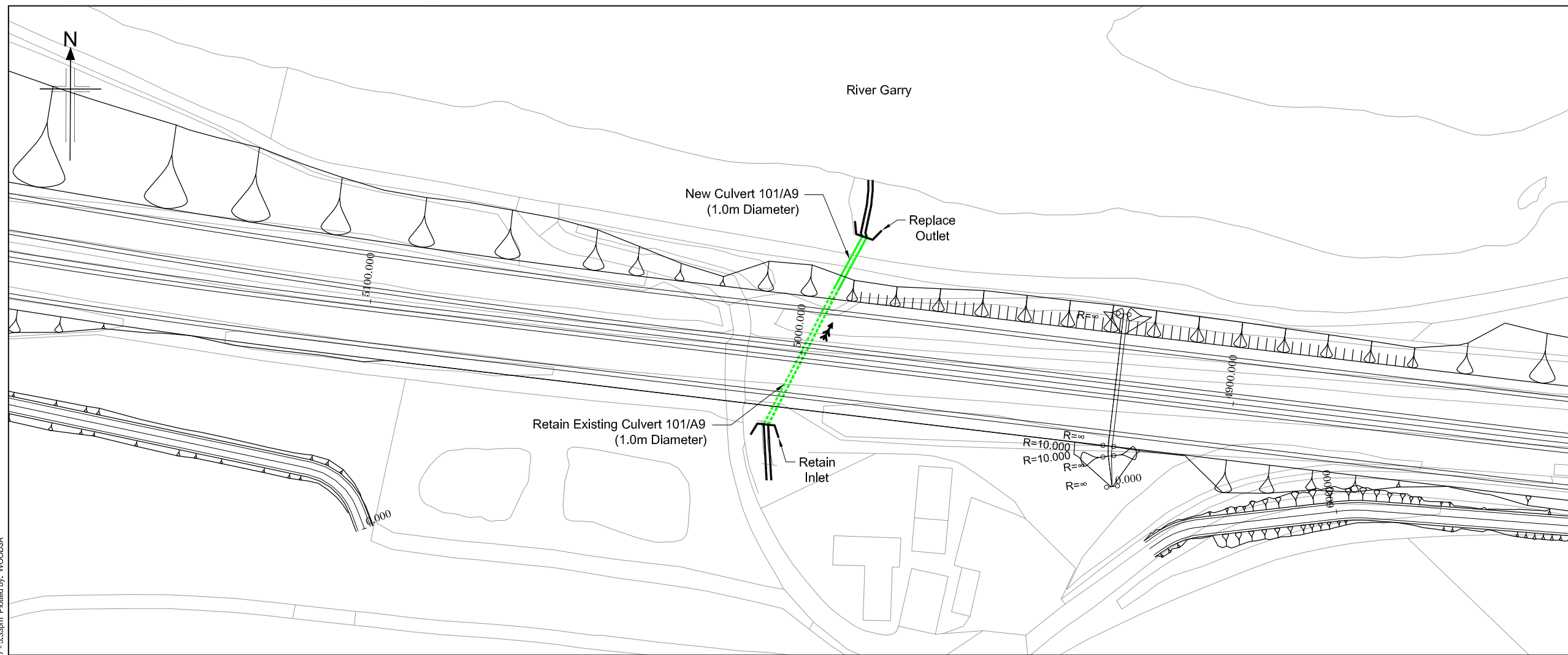

SCHEMATIC PLAN

- Legend:
- New culvert/extension
  - - - Retained culvert
  - Realigned/regraded channel
  - Cascade
  - Inlet/outlet headwall (new)
  - - - Inlet/outlet headwall (retained)
  - Pre-earthworks drain and outfall
  - Access chamber
  - ← Flow direction
  - IL Invert Level

- Notes:
1. All dimensions are in meters unless noted otherwise.
  2. All levels are in meters above ordnance datum.
  3. All details shown on this drawing are indicative only and subject to development at detailed design.
  4. This drawing shall be read in conjunction with the 'Watercourse Crossing report' only and not in isolation.
  5. All 'new' and 'extended' culverts have been designed in accordance with the relevant provisions of DMRB.
  6. Where required 'scour protection measures' shall be provided within the zone indicated on the drawing. The nature and the extent of the scour protection measure will be further developed at detailed design stage in accordance with the relevant provisions of DMRB, taking into account flow hydraulics, channel geometry and channel morphology.
  7. Where shown culverts shall be 'embedded' with natural river deposits to the depth shown.
  8. Where shown 'cascades' are required to safely convey the design flood event (0.5% AEP (200-year) plus allowance for climate change). The cascade geometry shown on the drawing is indicative only and will be subject to further development at detailed design stage. The nature of the cascade will take one of the following forms,
    - Bedrock channel cascade.
    - Natural cascade with natural gravels, cobbles and rock forming individual steps.
    - Concrete cascade with stone pitching.
 The nature of the cascade will be determined at the detailed design stage taking into account hydraulic requirements, topography and nature of the underlying strata and its susceptibility to fluvial erosion.
  9. Where shown mammal ledges will be provided within the culvert in accordance with the relevant provisions of DMRB.

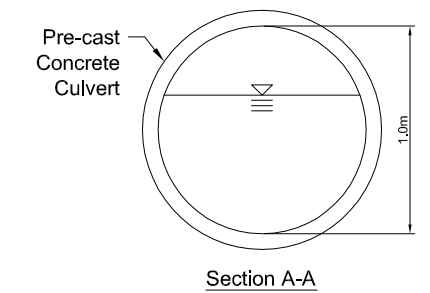

Section A-A

Rev	Rev. Date	Purpose of revision	Drawn	Checkd	Rev'd	Apprv'd
0	10/01/17	FOR INFORMATION				

**JACOBS**  
 95 Bothwell St, Glasgow, G2 7HX  
 Tel: +44(0)141 243 9000 Fax: +44(0)141 226 3109  
 www.jacobs.com



Drawing title  
**KILLIECRANKIE TO GLEN GARRY PROPOSED MODIFICATIONS TO CULVERT ON WATERCOURSE WF101**

Drawing status  
**FOR INFORMATION**

Scale  
 NTS @ A1 DO NOT SCALE

Jacobs No.  
 B2140005

Drawing number  
**Figure A.11.8.10**

Rev  
**0**

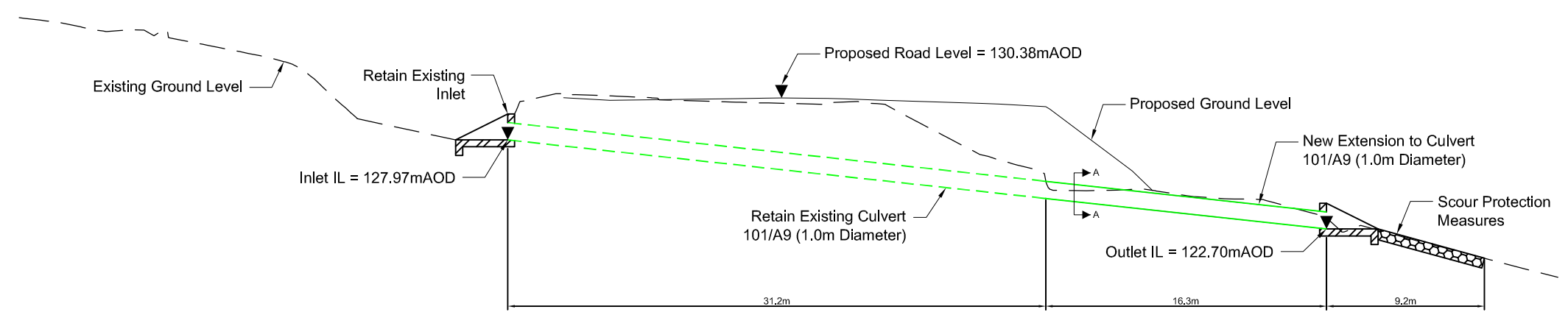

WATERCOURSE 101 LONGSECTION

File: I:\Glarif\07\10\11\ECBC\BWA\_Job\B2140005 A9 Dualling Temp folder\B2140005 A9 Dualling CAD\Watercourse Modifications\WF101.dwg Date: Aug 02, 2017 - 5:33pm Plotted by: WOODJA

Reproduced by permission of Ordnance Survey on behalf of HMSO.  
 © Crown copyright and database right 2017. All rights reserved.  
 Ordnance Survey Licence number 100046668.

© Copyright 2017 Jacobs U.K. Limited. The concepts and information contained in this document are the property of Jacobs. Use or copying of this document in whole or in part without the written permission of Jacobs constitutes an infringement of copyright. Limitation: This drawing has been prepared on behalf of, and for the exclusive use of, Jacobs Client, and is subject to, and issued in accordance with, the provisions of the contract between Jacobs and the Client. Jacobs accepts no liability or responsibility whatsoever for, or in respect of, any use of, or reliance upon, this drawing by any third party.

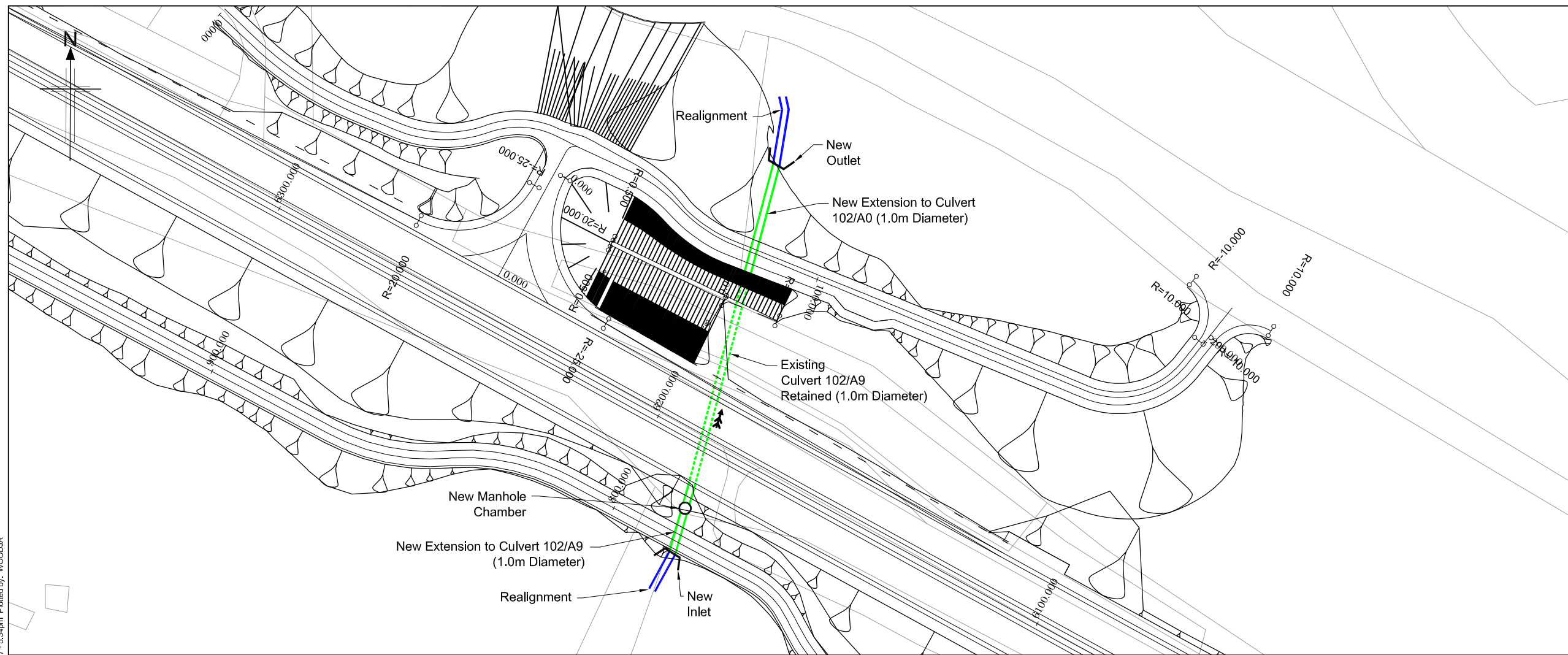

- Legend:
- New culvert/extension
  - - - Retained culvert
  - Realigned/regraded channel
  - Cascade
  - Inlet/outlet headwall (new)
  - - - Inlet/outlet headwall (retained)
  - Pre-earthworks drain and outfall
  - Access chamber
  - ← Flow direction
  - IL Invert Level

- Notes:
1. All dimensions are in meters unless noted otherwise.
  2. All levels are in meters above ordnance datum.
  3. All details shown on this drawing are indicative only and subject to development at detailed design.
  4. This drawing shall be read in conjunction with the 'Watercourse Crossing report' only and not in isolation.
  5. All 'new' and 'extended' culverts have been designed in accordance with the relevant provisions of DMRB.
  6. Where required 'scour protection measures' shall be provided within the zone indicated on the drawing. The nature and the extent of the scour protection measure will be further developed at detailed design stage in accordance with the relevant provisions of DMRB, taking into account flow hydraulics, channel geometry and channel morphology.
  7. Where shown culverts shall be 'embedded' with natural river deposits to the depth shown.
  8. Where shown 'cascades' are required to safely convey the design flood event (0.5% AEP (200-year) plus allowance for climate change). The cascade geometry shown on the drawing is indicative only and will be subject to further development at detailed design stage. The nature of the cascade will take one of the following forms,
    - Bedrock channel cascade.
    - Natural cascade with natural gravels, cobbles and rock forming individual steps.
    - Concrete cascade with stone pitching.
 The nature of the cascade will be determined at the detailed design stage taking into account hydraulic requirements, topography and nature of the underlying strata and its susceptibility to fluvial erosion.
  9. Where shown mammal ledges will be provided within the culvert in accordance with the relevant provisions of DMRB.

**SCHEMATIC PLAN**

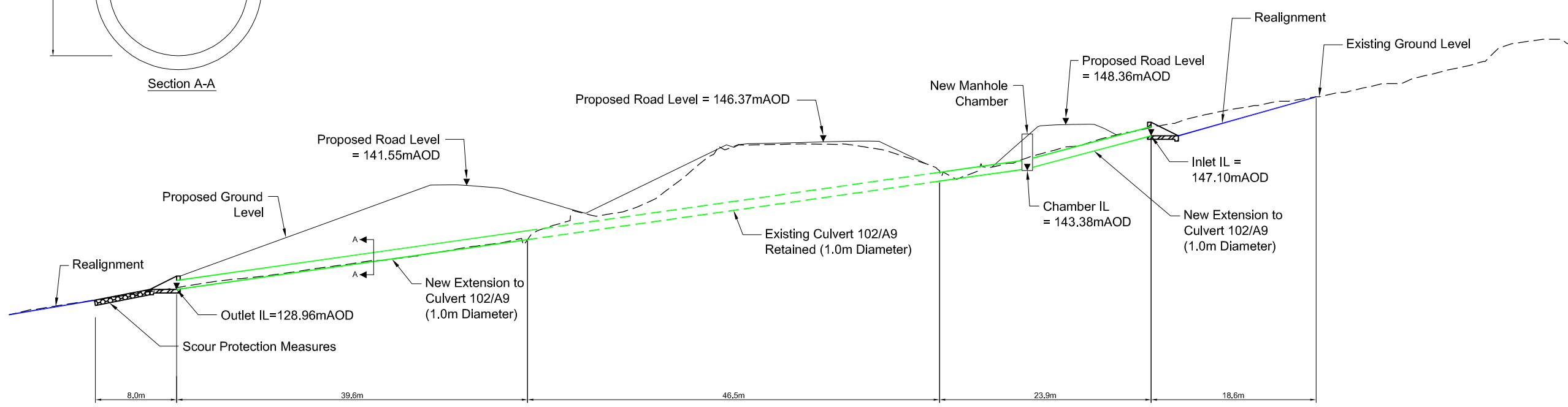
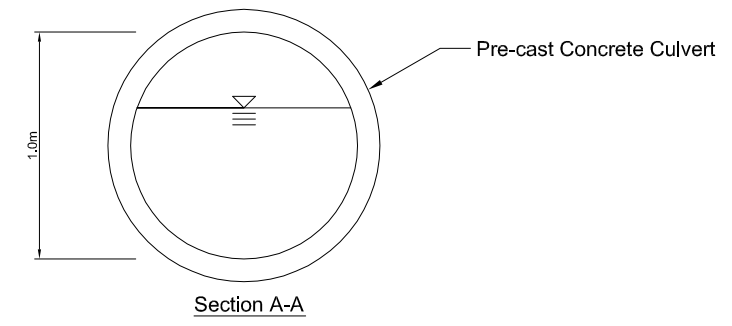

Rev	Rev. Date	Purpose of revision	Drawn	Checkd	Rev'd	Apprv'd
0	20/01/17	FOR INFORMATION	CON	JW	LMG	



**KILLIECRANKIE TO GLEN GARRY PROPOSED MODIFICATIONS TO CULVERT ON WATERCOURSE WF102**

Drawing status: **FOR INFORMATION**

Scale: NTS @ A1 DO NOT SCALE  
 Jacobs No. B2140005  
 Drawing number: **Figure A.11.8.11**

Rev: **0**

Reproduced by permission of Ordnance Survey on behalf of HMSO. © Crown copyright and database right 2017. All rights reserved. Ordnance Survey Licence number 100046668.

**WATERCOURSE 102 LONGSECTION**

File: I:\Glen\07\PV01\1\ECBC\BWA\_Job\B2140005 A9 Dualing Temp folder\B2140005 Killiecrankie to Pitagowan\CAD\Watercourse Modifications\WF102.dwg Date: Aug 02, 2017 - 5:34pm Plotted by: WOODJJA

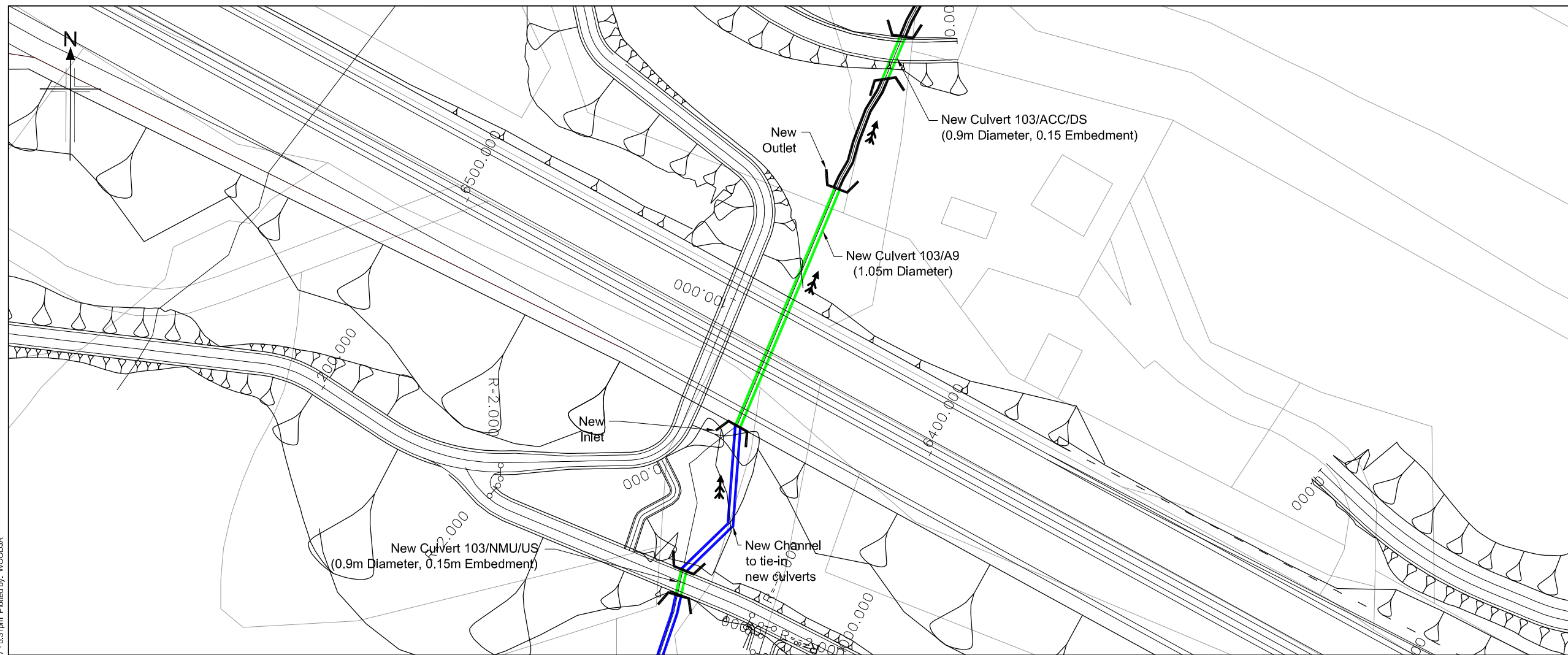

SCHEMATIC PLAN

- Legend:
- New culvert/extension
  - - - Retained culvert
  - Realigned/regraded channel
  - Cascade
  - Inlet/outlet headwall (new)
  - - - Inlet/outlet headwall (retained)
  - Pre-earthworks drain and outfall
  - Access chamber
  - Flow direction
  - IL Invert Level

- Notes:
1. All dimensions are in meters unless noted otherwise.
  2. All levels are in meters above ordnance datum.
  3. All details shown on this drawing are indicative only and subject to development at detailed design.
  4. This drawing shall be read in conjunction with the 'Watercourse Crossing report' only and not in isolation.
  5. All 'new' and 'extended' culverts have been designed in accordance with the relevant provisions of DMRB.
  6. Where required 'scour protection measures' shall be provided within the zone indicated on the drawing. The nature and the extent of the scour protection measure will be further developed at detailed design stage in accordance with the relevant provisions of DMRB, taking into account flow hydraulics, channel geometry and channel morphology.
  7. Where shown culverts shall be 'embedded' with natural river deposits to the depth shown.
  8. Where shown 'cascades' are required to safely convey the design flood event (0.5% AEP (200-year) plus allowance for climate change). The cascade geometry shown on the drawing is indicative only and will be subject to further development at detailed design stage. The nature of the cascade will take one of the following forms,
    - Bedrock channel cascade.
    - Natural cascade with natural gravels, cobbles and rock forming individual steps.
    - Concrete cascade with stone pitching.
 The nature of the cascade will be determined at the detailed design stage taking into account hydraulic requirements, topography and nature of the underlying strata and its susceptibility to fluvial erosion.
  9. Where shown mammal ledges will be provided within the culvert in accordance with the relevant provisions of DMRB.

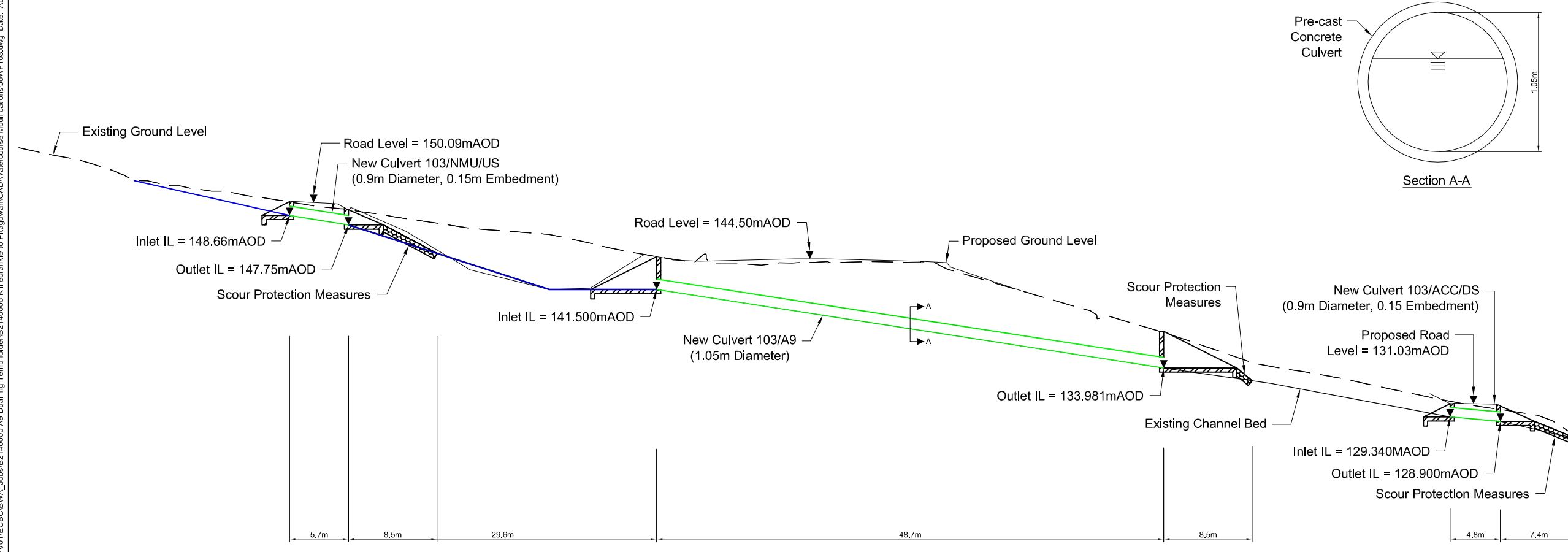

WATERCOURSE 103 LONGSECTION

Rev	Rev. Date	Purpose of revision	Drawn	Checkd	Rev'd	Apprv'd
0	13/01/17	FOR INFORMATION				



**KILLIECRANKIE TO GLEN GARRY PROPOSED MODIFICATIONS TO CULVERT ON WATERCOURSE WF103**

Scale	NTS @ A1	DO NOT SCALE
Jacobs No.	B2140005	

Drawing number **Figure A.11.8.12** Rev **0**

Reproduced by permission of Ordnance Survey on behalf of HMSO. © Crown copyright and database right 2017. All rights reserved. Ordnance Survey Licence number 100046668.

© Copyright 2017 Jacobs U.K. Limited. The concepts and information contained in this document are the property of Jacobs. Use or copying of this document in whole or in part without the written permission of Jacobs constitutes an infringement of copyright. Limitation: This drawing has been prepared on behalf of, and for the exclusive use of, Jacobs Client, and is subject to, and limited in accordance with, the provisions of the contract between Jacobs and the Client. Jacobs accepts no liability or responsibility whatsoever for, or in respect of, any use of, or reliance upon, this drawing by any third party.

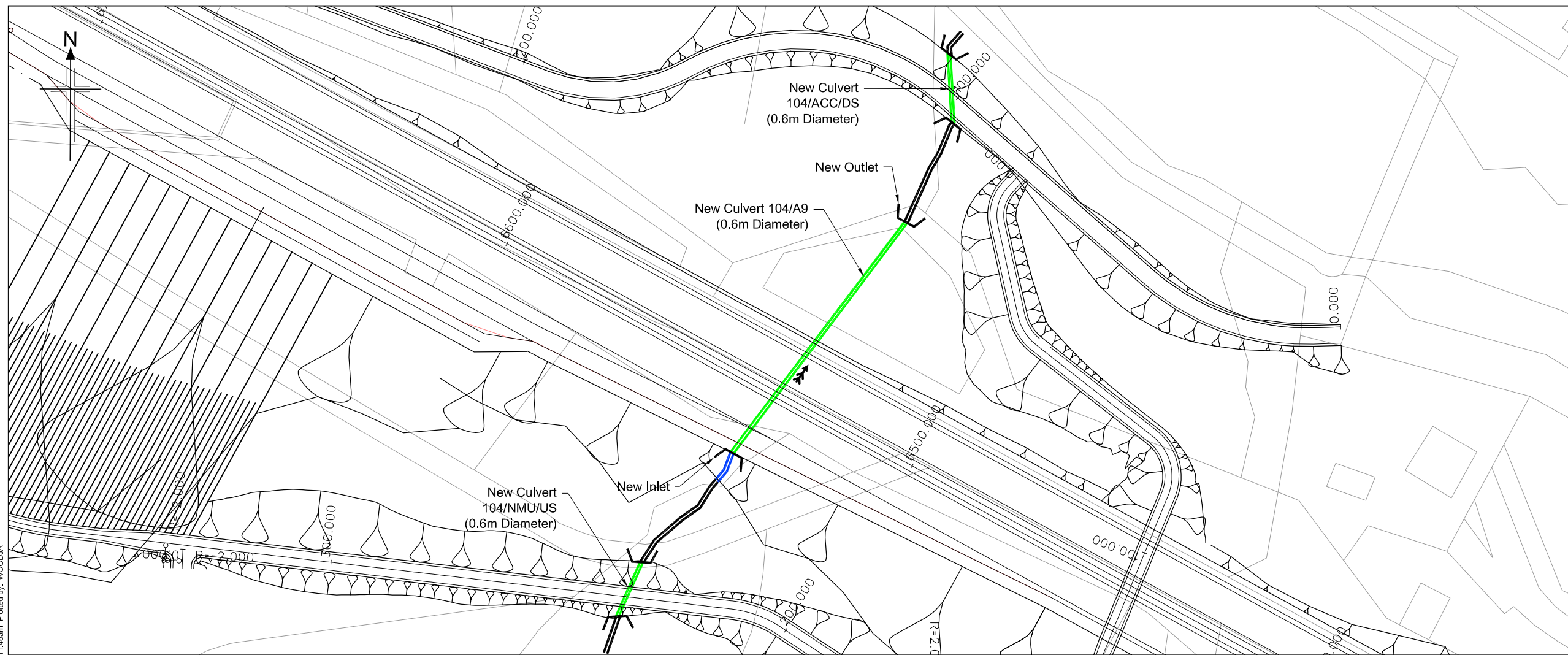

**Legend:**

- New culvert/extension
- - - Retained culvert
- Realigned/regraded channel
- Cascade
- Inlet/outlet headwall (new)
- - - Inlet/outlet headwall (retained)
- Pre-earthworks drain and outfall
- Access chamber
- Flow direction
- IL Invert Level

- Notes:**
1. All dimensions are in meters unless noted otherwise.
  2. All levels are in meters above ordnance datum.
  3. All details shown on this drawing are indicative only and subject to development at detailed design.
  4. This drawing shall be read in conjunction with the 'Watercourse Crossing report' only and not in isolation.
  5. All 'new' and 'extended' culverts have been designed in accordance with the relevant provisions of DMRB.
  6. Where required 'scour protection measures' shall be provided within the zone indicated on the drawing. The nature and the extent of the scour protection measure will be further developed at detailed design stage in accordance with the relevant provisions of DMRB, taking into account flow hydraulics, channel geometry and channel morphology.
  7. Where shown culverts shall be 'embedded' with natural river deposits to the depth shown.
  8. Where shown 'cascades' are required to safely convey the design flood event (0.5% AEP (200-year) plus allowance for climate change). The cascade geometry shown on the drawing is indicative only and will be subject to further development at detailed design stage. The nature of the cascade will take one of the following forms,
    - Bedrock channel cascade.
    - Natural cascade with natural gravels, cobbles and rock forming individual steps.
    - Concrete cascade with stone pitching.
 The nature of the cascade will be determined at the detailed design stage taking into account hydraulic requirements, topography and nature of the underlying strata and its susceptibility to fluvial erosion.
  9. Where shown mammal ledges will be provided within the culvert in accordance with the relevant provisions of DMRB.

**SCHEMATIC PLAN**

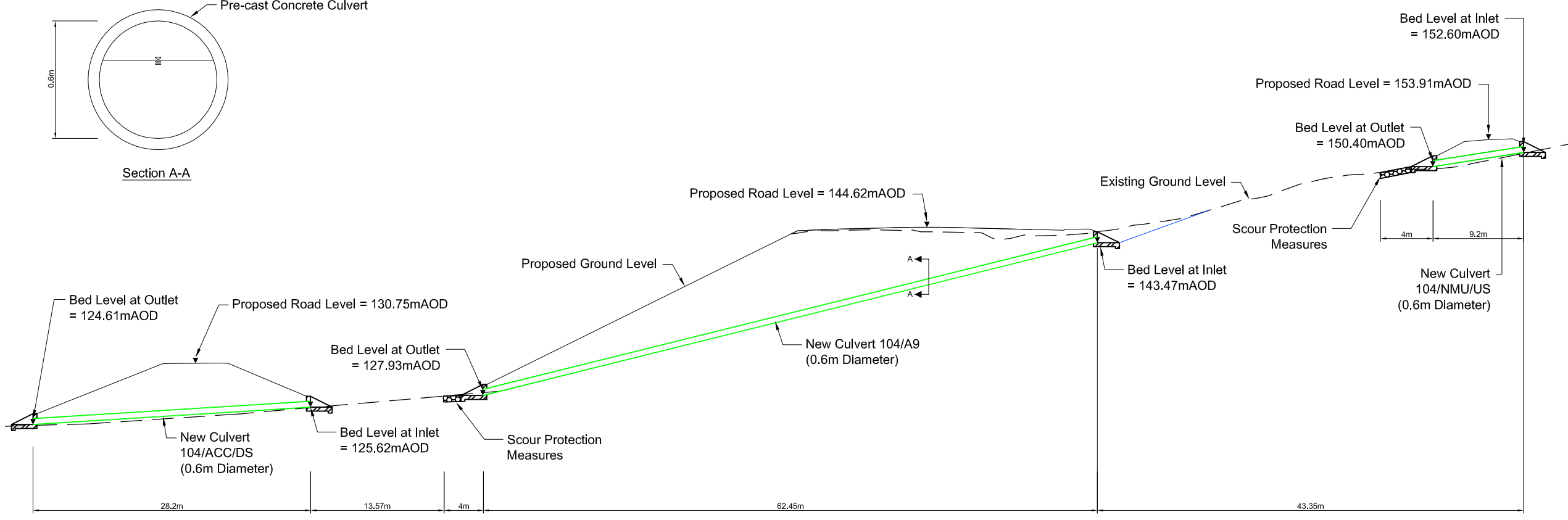
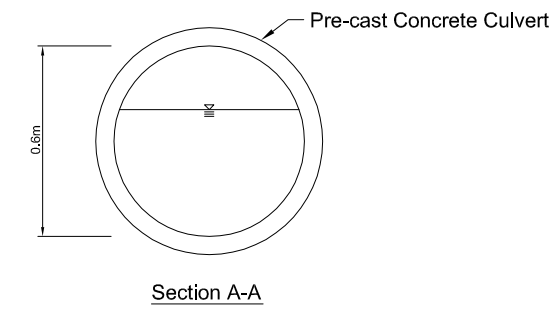

Rev	Rev. Date	Purpose of revision	Drawn	Checked	Rev'd	Apprv'd
0	20/01/17	FOR INFORMATION	CON	JW	LMG	



Drawing title  
**KILLIECRANKIE TO GLEN GARRY PROPOSED MODIFICATIONS TO CULVERT ON WATERCOURSE WF104**

Drawing status: **FOR INFORMATION**

Scale	NTS @ A1	DO NOT SCALE
Jacobs No.	B2140005	

Drawing number	Figure A.11.8.13	Rev	0
----------------	------------------	-----	---

Reproduced by permission of Ordnance Survey on behalf of HMSO.  
© Crown copyright and database right 2017. All rights reserved.  
Ordnance Survey Licence number 100046668.

**WATERCOURSE 104 LONGSECTION**

© Copyright 2017 Jacobs U.K. Limited. The concepts and information contained in this document are the property of Jacobs. Use or copying of this document in whole or in part without the written permission of Jacobs constitutes an infringement of copyright. Limitation: This drawing has been prepared on behalf of, and for the exclusive use of, Jacobs Client, and is subject to, and issued in accordance with, the provisions of the contract between Jacobs and the Client. Jacobs accepts no liability or responsibility whatsoever for, or in respect of, any use of, or reliance upon, this drawing by any third party.

File: I:\Glarif\07\PV01\ECBC\BWA\_Job\B2140005 A9 Dualing Temp folder\B2140005 Killiecrankie to Pilegowan\CAD\Watercourse Modifications\WF104.dwg Date: Jul 31, 2017 - 11:48am Plotted by: WOODJIA

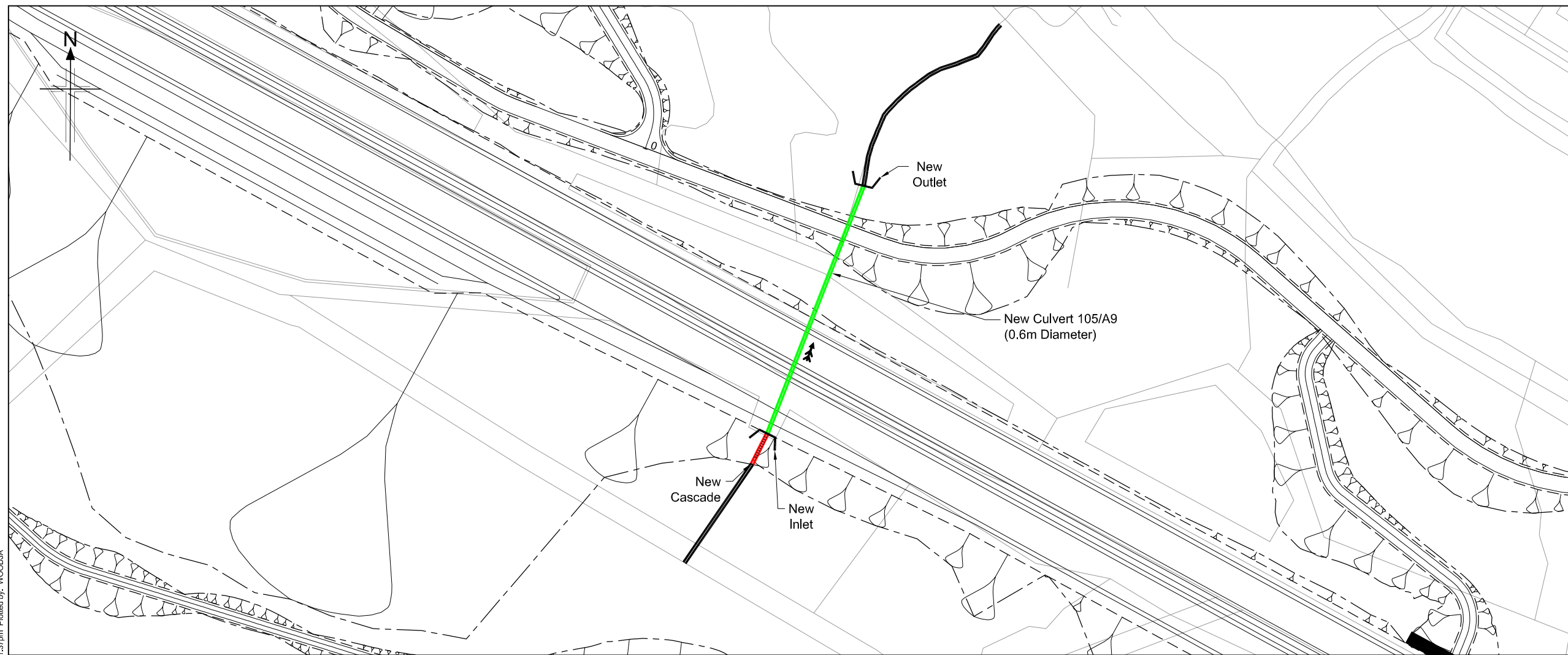

- Legend:**
- New culvert/extension
  - - - Retained culvert
  - Realigned/regraded channel
  - Cascade
  - Inlet/outlet headwall (new)
  - - - Inlet/outlet headwall (retained)
  - Pre-earthworks drain and outfall
  - Access chamber
  - Flow direction
  - IL Invert Level

- Notes:**
1. All dimensions are in meters unless noted otherwise.
  2. All levels are in meters above ordnance datum.
  3. All details shown on this drawing are indicative only and subject to development at detailed design.
  4. This drawing shall be read in conjunction with the 'Watercourse Crossing report' only and not in isolation.
  5. All 'new' and 'extended' culverts have been designed in accordance with the relevant provisions of DMRB.
  6. Where required 'scour protection measures' shall be provided within the zone indicated on the drawing. The nature and the extent of the scour protection measure will be further developed at detailed design stage in accordance with the relevant provisions of DMRB, taking into account flow hydraulics, channel geometry and channel morphology.
  7. Where shown culverts shall be 'embedded' with natural river deposits to the depth shown.
  8. Where shown 'cascades' are required to safely convey the design flood event (0.5% AEP (200-year) plus allowance for climate change). The cascade geometry shown on the drawing is indicative only and will be subject to further development at detailed design stage. The nature of the cascade will take one of the following forms,
    - Bedrock channel cascade.
    - Natural cascade with natural gravels, cobbles and rock forming individual steps.
    - Concrete cascade with stone pitching.
 The nature of the cascade will be determined at the detailed design stage taking into account hydraulic requirements, topography and nature of the underlying strata and its susceptibility to fluvial erosion.
  9. Where shown mammal ledges will be provided within the culvert in accordance with the relevant provisions of DMRB.

SCHEMATIC PLAN

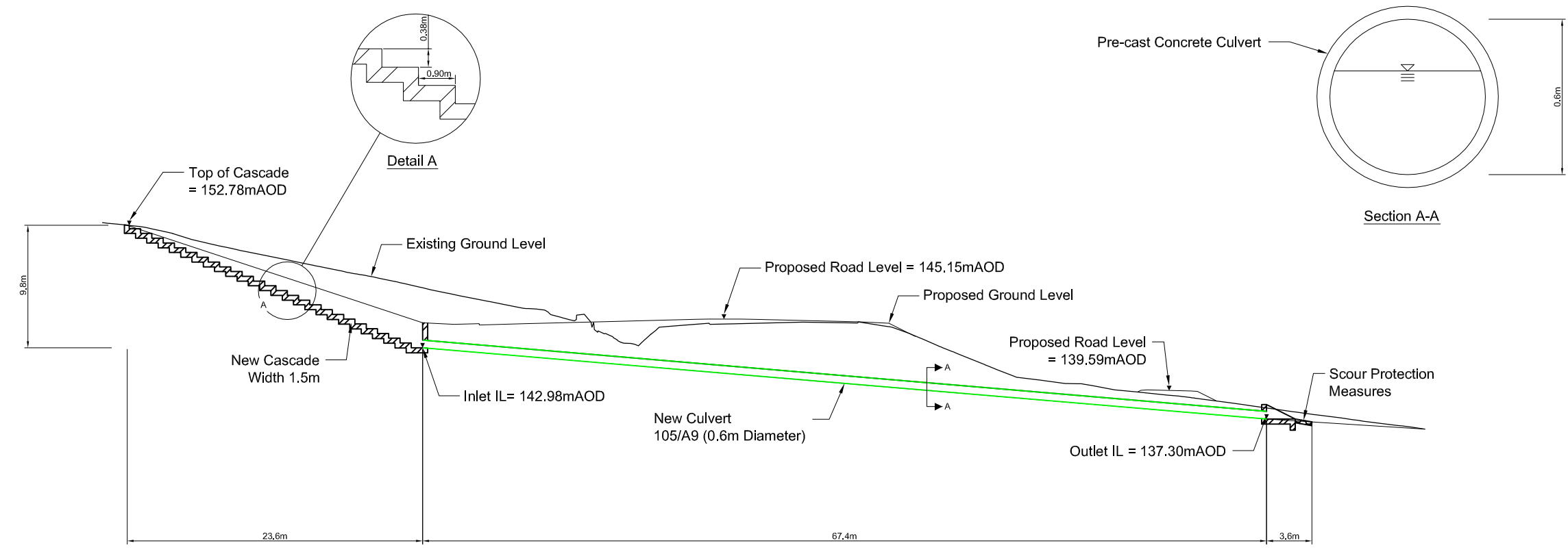

WATERCOURSE 105 LONGSECTION

Rev	Rev. Date	Purpose of revision	Drawn	Checkd	Rev'd	Apprv'd
0	10/01/17	FOR INFORMATION	CON	JW	LMG	

**JACOBS**  
 95 Bothwell St, Glasgow, G2 7HX  
 Tel: +44(0)141 243 9000 Fax: +44(0)141 226 3109  
 www.jacobs.com



**KILLIECRANKIE TO GLEN GARRY  
 PROPOSED MODIFICATIONS  
 TO CULVERT ON  
 WATERCOURSE WF105**

Drawing status: **FOR INFORMATION**

Scale: NTS @ A1 DO NOT SCALE  
 Jacobs No. B2140005

Drawing number: **Figure A.11.8.14** Rev 0

Reproduced by permission of Ordnance Survey on behalf of HMSO.  
 © Crown copyright and database right 2017. All rights reserved.  
 Ordnance Survey Licence number 100046668.

© Copyright 2017 Jacobs U.K. Limited. The concepts and information contained in this document are the property of Jacobs. Use or copying of this document in whole or in part without the written permission of Jacobs constitutes an infringement of copyright. Limitation: This drawing has been prepared on behalf of, and for the exclusive use of, Jacobs Client, and is subject to, and limited in accordance with, the provisions of the contract between Jacobs and the Client. Jacobs accepts no liability or responsibility whatsoever for, or in respect of, any use of, or reliance upon, this drawing by any third party.

File: I:\Glarif\07\PV01\ECBC\BWA\_JoosIB2140000 A9 Dualling Temp folder\B2140000 A9 Dualling\CAD\Watercourse Modifications\WF105.dwg Date: Jul 27, 2017 - 13:37pm Plotted by: WOODJA

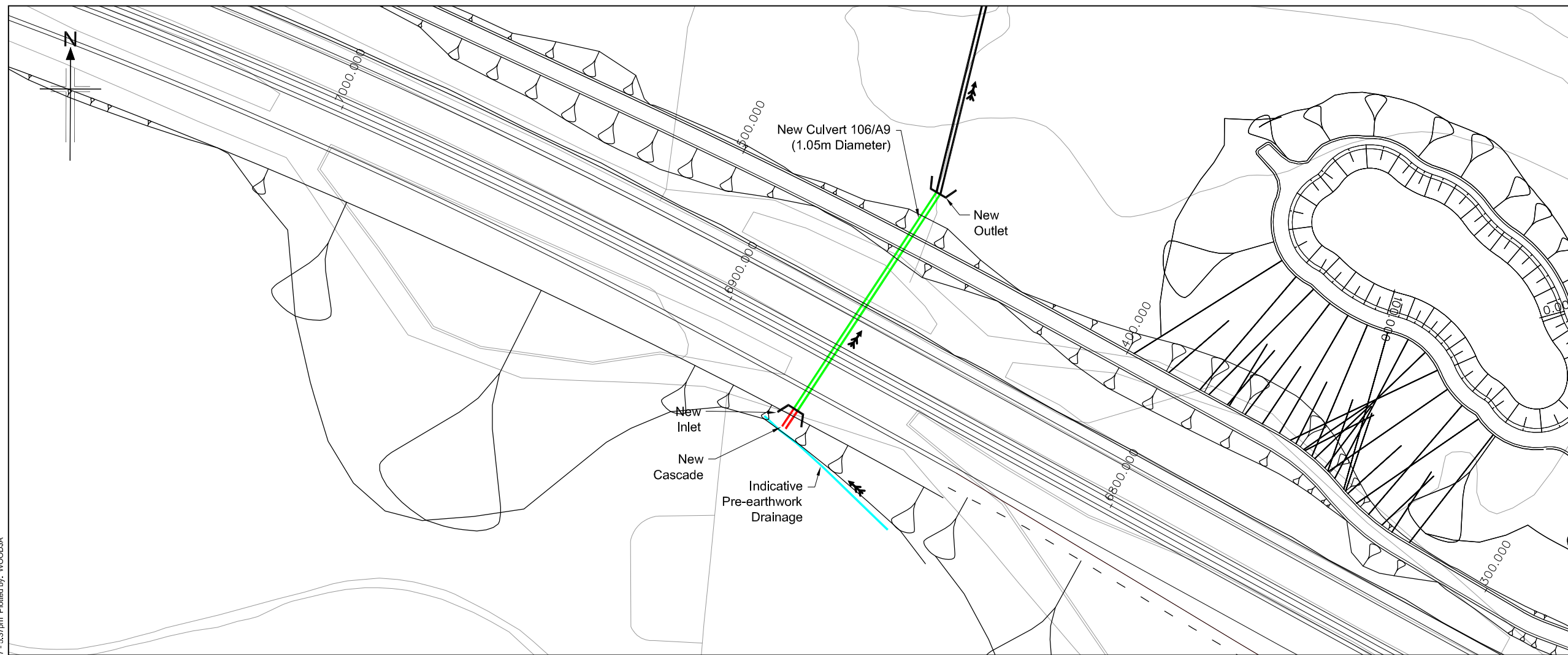

- Legend:**
- New culvert/extension
  - - - Retained culvert
  - Realigned/regraded channel
  - Cascade
  - Inlet/outlet headwall (new)
  - - - Inlet/outlet headwall (retained)
  - Pre-earthworks drain and outfall
  - Access chamber
  - Flow direction
  - IL Invert Level

- Notes:**
1. All dimensions are in meters unless noted otherwise.
  2. All levels are in meters above ordnance datum.
  3. All details shown on this drawing are indicative only and subject to development at detailed design.
  4. This drawing shall be read in conjunction with the 'Watercourse Crossing report' only and not in isolation.
  5. All 'new' and 'extended' culverts have been designed in accordance with the relevant provisions of DMRB.
  6. Where required 'scour protection measures' shall be provided within the zone indicated on the drawing. The nature and the extent of the scour protection measure will be further developed at detailed design stage in accordance with the relevant provisions of DMRB, taking into account flow hydraulics, channel geometry and channel morphology.
  7. Where shown culverts shall be 'embedded' with natural river deposits to the depth shown.
  8. Where shown 'cascades' are required to safely convey the design flood event (0.5% AEP (200-year) plus allowance for climate change). The cascade geometry shown on the drawing is indicative only and will be subject to further development at detailed design stage. The nature of the cascade will take one of the following forms,
    - Bedrock channel cascade.
    - Natural cascade with natural gravels, cobbles and rock forming individual steps.
    - Concrete cascade with stone pitching.
 The nature of the cascade will be determined at the detailed design stage taking into account hydraulic requirements, topography and nature of the underlying strata and its susceptibility to fluvial erosion.
  9. Where shown mammal ledges will be provided within the culvert in accordance with the relevant provisions of DMRB.

**SCHEMATIC PLAN**

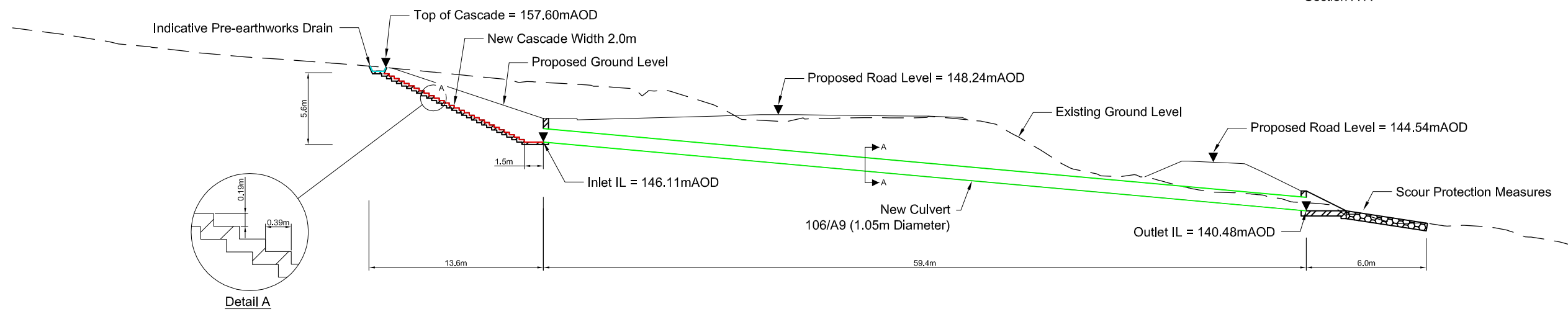
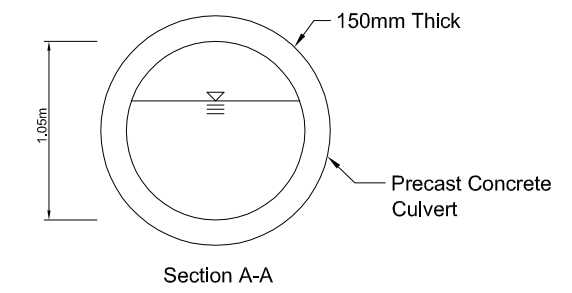

**WATERCOURSE 106 LONGSECTION**

D	10/01/17	FOR INFORMATION	CON	JW	LMG	
Rev	Rev. Date	Purpose of revision	Drawn	Checked	Rev'd	Apprv'd



95 Bothwell St, Glasgow, G2 7HX  
Tel: +44(0)141 243 9000 Fax: +44(0)141 226 3109  
www.jacobs.com



**KILLIECRANKIE TO GLEN GARRY  
PROPOSED MODIFICATIONS  
TO CULVERT ON  
WATERCOURSE WF106**

Drawing status: **FOR INFORMATION**

Scale: NTS @ A1 DO NOT SCALE

Jacobs No. B2140005

Drawing number: **Figure A.11.8.15** Rev: **0**

File: I:\Glarif\07\PV01\1ECBC\BWA\_Joosib2140000 A9 Dualing Temp folder\B2140000 A9 Dualing CAD\Watercourse Modifications\WF106.dwg Date: Aug 02, 2017 - 5:37pm Plotted by: WOODJA

Reproduced by permission of Ordnance Survey on behalf of HMSO.  
© Crown copyright and database right 2017. All rights reserved.  
Ordnance Survey Licence number 100046668.

© Copyright 2017 Jacobs U.K. Limited. The concepts and information contained in this document are the property of Jacobs. Use or copying of this document in whole or in part without the written permission of Jacobs constitutes an infringement of copyright. Limitation: This drawing has been prepared on behalf of, and for the exclusive use of, Jacobs Client, and is subject to, and issued in accordance with, the provisions of the contract between Jacobs and the Client. Jacobs accepts no liability or responsibility whatsoever for, or in respect of, any use of, or reliance upon, this drawing by any third party.

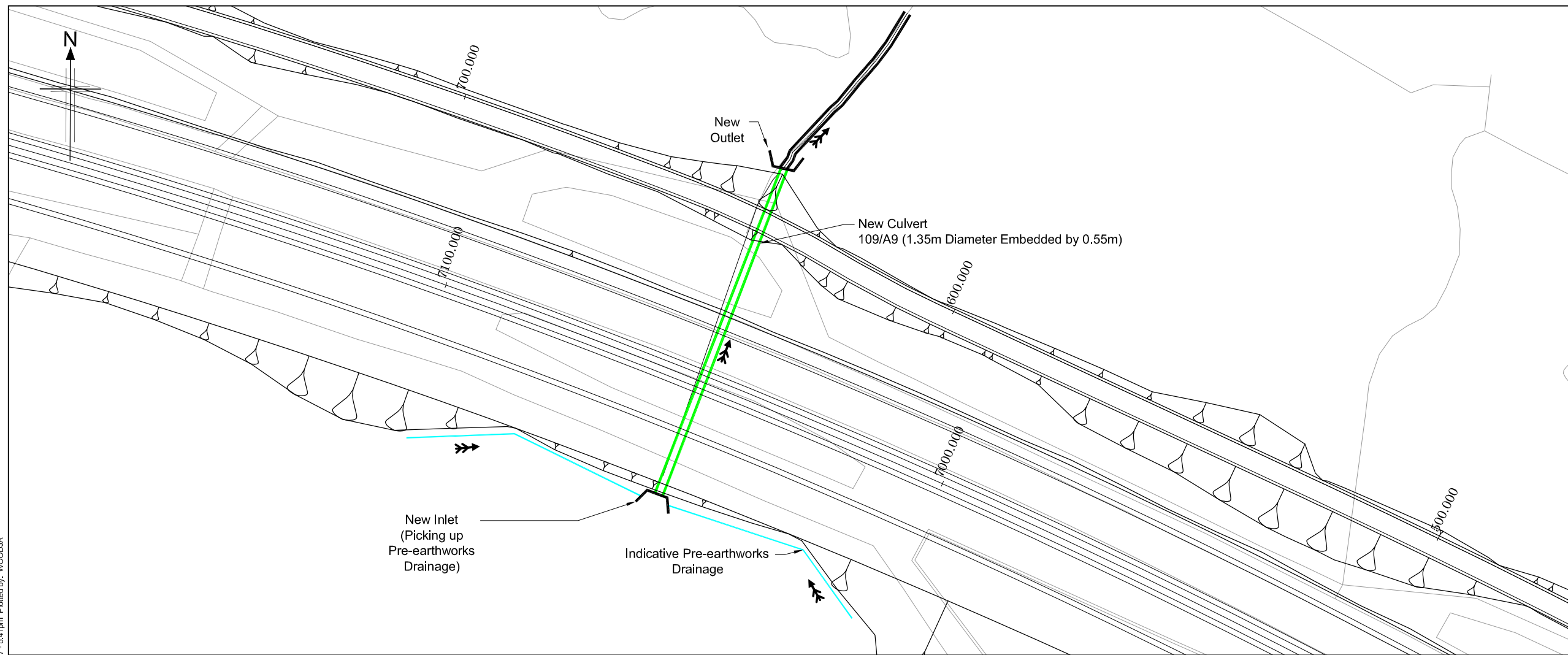

SCHEMATIC PLAN

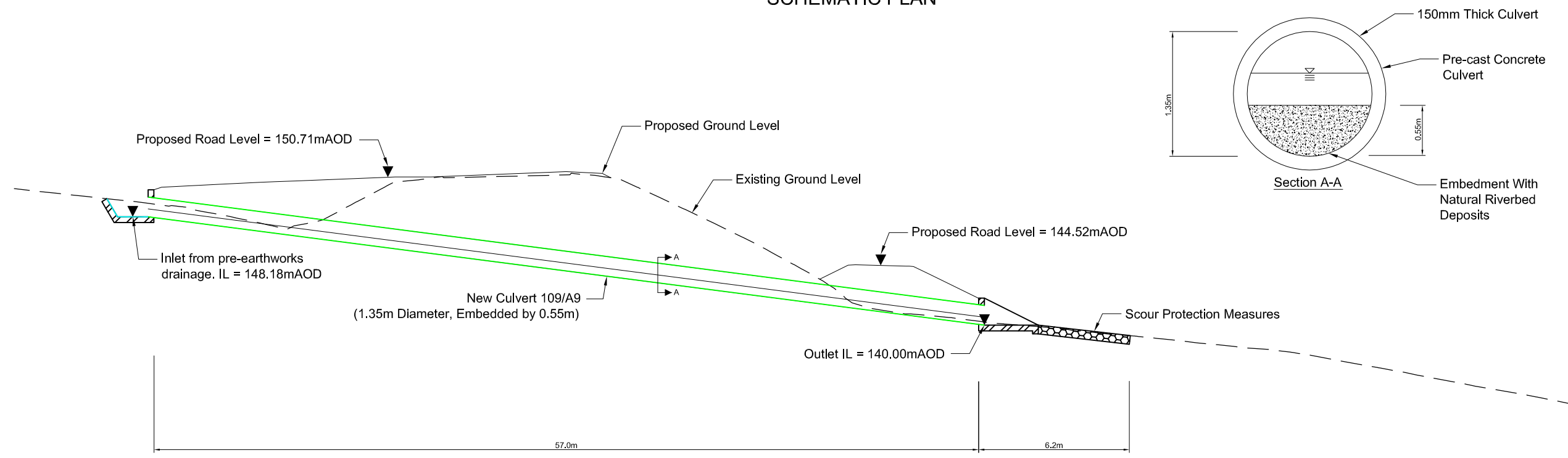

WATERCOURSE 107 LONGSECTION

- Legend:
- New culvert/extension
  - - - Retained culvert
  - Realigned/regraded channel
  - Cascade
  - Inlet/outlet headwall (new)
  - - - Inlet/outlet headwall (retained)
  - Pre-earthworks drain and outfall
  - Access chamber
  - Flow direction
  - IL Invert Level

- Notes:
1. All dimensions are in meters unless noted otherwise.
  2. All levels are in meters above ordnance datum.
  3. All details shown on this drawing are indicative only and subject to development at detailed design.
  4. This drawing shall be read in conjunction with the 'Watercourse Crossing report' only and not in isolation.
  5. All 'new' and 'extended' culverts have been designed in accordance with the relevant provisions of DMRB.
  6. Where required 'scour protection measures' shall be provided within the zone indicated on the drawing. The nature and the extent of the scour protection measure will be further developed at detailed design stage in accordance with the relevant provisions of DMRB, taking into account flow hydraulics, channel geometry and channel morphology.
  7. Where shown culverts shall be 'embedded' with natural river deposits to the depth shown.
  8. Where shown 'cascades' are required to safely convey the design flood event (0.5% AEP (200-year) plus allowance for climate change). The cascade geometry shown on the drawing is indicative only and will be subject to further development at detailed design stage. The nature of the cascade will take one of the following forms,
    - Bedrock channel cascade.
    - Natural cascade with natural gravels, cobbles and rock forming individual steps.
    - Concrete cascade with stone pitching.
 The nature of the cascade will be determined at the detailed design stage taking into account hydraulic requirements, topography and nature of the underlying strata and its susceptibility to fluvial erosion.
  9. Where shown mammal ledges will be provided within the culvert in accordance with the relevant provisions of DMRB.

D	10/01/17	FOR INFORMATION	CON	JW	LMG	
Rev	Rev. Date	Purpose of revision	Drawn	Checkd	Rev'd	Apprv'd



Drawing title  
**KILLIECRANKIE TO GLEN GARRY  
 PROPOSED MODIFICATIONS  
 TO CULVERT ON  
 WATERCOURSE WF107**

Drawing status  
**FOR INFORMATION**

Scale  
 NTS @ A1      DO NOT SCALE

Jacobs No.  
 B2140005

Drawing number  
**Figure A.11.8.16**

Rev  
**0**

File: I:\Glarif\07\PV01\ECBC\BWA\_Job\B2140005\_Killiecrankie to Pitegowan\CAD\Watercourse Modifications\WF107.dwg Date: Aug 02, 2017 - 5:41 pm Plotted by: WOODJJA

Reproduced by permission of Ordnance Survey on behalf of HMSO.  
 © Crown copyright and database right 2017. All rights reserved.  
 Ordnance Survey Licence number 100046668.

© Copyright 2017 Jacobs U.K. Limited. The concepts and information contained in this document are the property of Jacobs. Use or copying of this document in whole or in part without the written permission of Jacobs constitutes an infringement of copyright. Limitation: This drawing has been prepared on behalf of, and for the exclusive use of, Jacobs Client, and is subject to, and limited in accordance with, the provisions of the contract between Jacobs and the Client. Jacobs accepts no liability or responsibility whatsoever for, or in respect of, any use of, or reliance upon, this drawing by any third party.

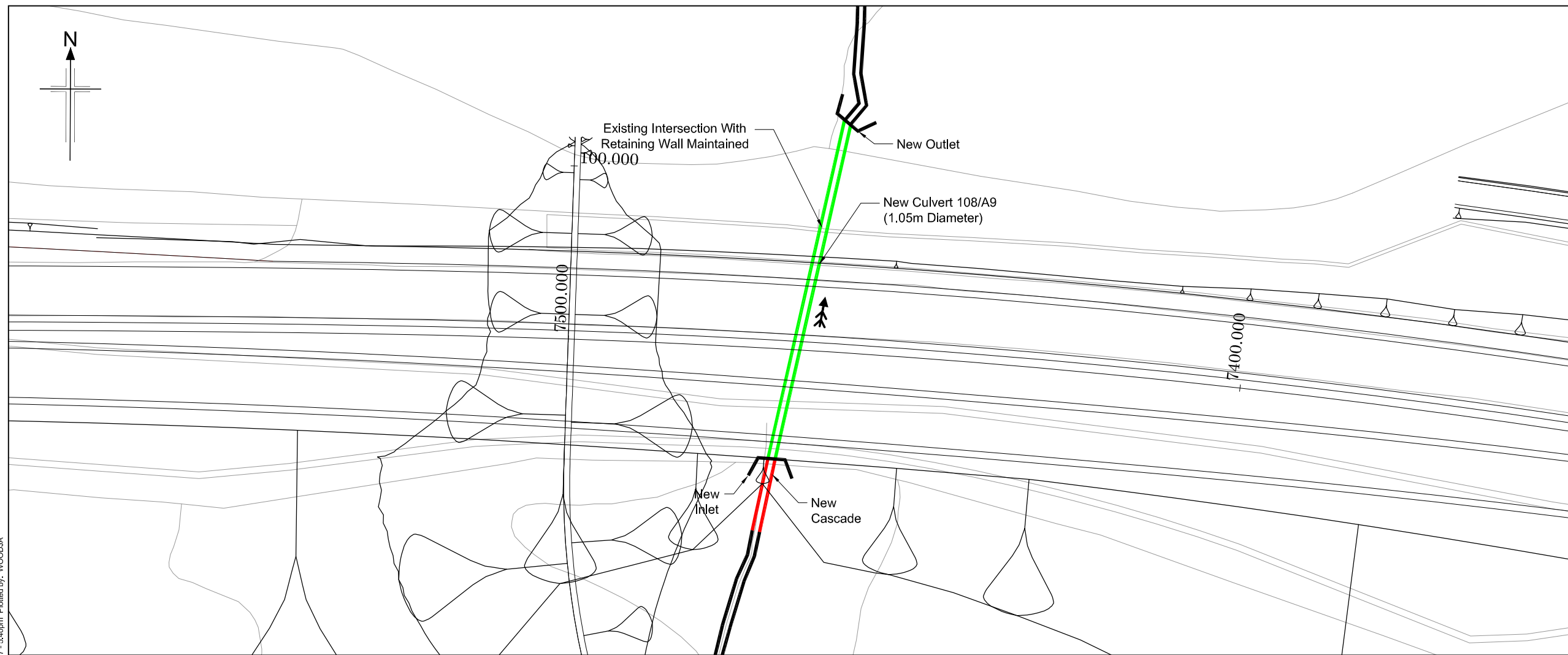

**SCHEMATIC PLAN**

- Legend:**
- New culvert/extension
  - - - Retained culvert
  - Realigned/regraded channel
  - Cascade
  - Inlet/outlet headwall (new)
  - Inlet/outlet headwall (retained)
  - Pre-earthworks drain and outfall
  - Access chamber
  - Flow direction
  - IL

- Notes:**
1. All dimensions are in meters unless noted otherwise.
  2. All levels are in meters above ordnance datum.
  3. All details shown on this drawing are indicative only and subject to development at detailed design.
  4. This drawing shall be read in conjunction with the 'Watercourse Crossing report' only and not in isolation.
  5. All 'new' and 'extended' culverts have been designed in accordance with the relevant provisions of DMRB.
  6. Where required 'scour protection measures' shall be provided within the zone indicated on the drawing. The nature and the extent of the scour protection measure will be further developed at detailed design stage in accordance with the relevant provisions of DMRB, taking into account flow hydraulics, channel geometry and channel morphology.
  7. Where shown culverts shall be 'embedded' with natural river deposits to the depth shown.
  8. Where shown 'cascades' are required to safely convey the design flood event (0.5% AEP (200-year) plus allowance for climate change). The cascade geometry shown on the drawing is indicative only and will be subject to further development at detailed design stage. The nature of the cascade will take one of the following forms,
    - Bedrock channel cascade.
    - Natural cascade with natural gravels, cobbles and rock forming individual steps.
    - Concrete cascade with stone pitching.
 The nature of the cascade will be determined at the detailed design stage taking into account hydraulic requirements, topography and nature of the underlying strata and its susceptibility to fluvial erosion.
  9. Where shown mammal ledges will be provided within the culvert in accordance with the relevant provisions of DMRB.

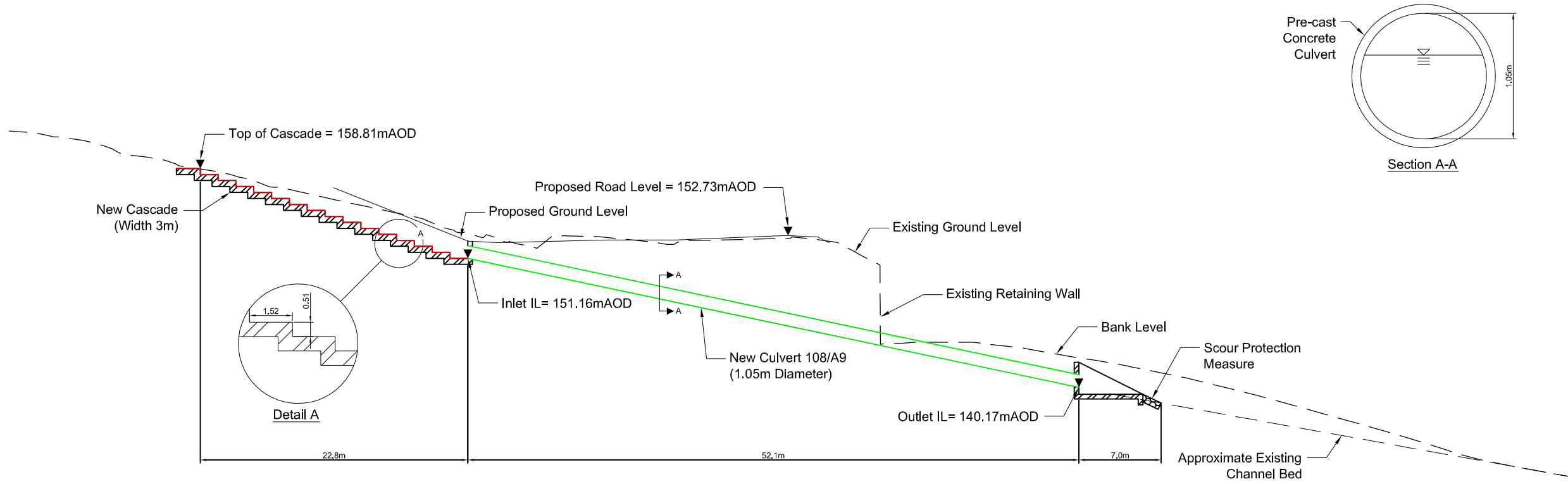

**WATERCOURSE 108 LONGSECTION**

Rev	Rev. Date	Purpose of revision	Drawn	Checked	Rev'd	Apprv'd
0	10/01/17	FOR INFORMATION				



**Drawing title**  
 KILLIECRANKIE TO GLEN GARRY  
 PROPOSED MODIFICATIONS  
 TO CULVERT ON  
 WATERCOURSE WF108

**Drawing status**  
 FOR INFORMATION

Scale: NTS @ A1 | DO NOT SCALE  
 Jacobs No.: B2140005

Drawing number: Figure A.11.8.17 | Rev: 0

Reproduced by permission of Ordnance Survey on behalf of HMSO.  
 © Crown copyright and database right 2017. All rights reserved.  
 Ordnance Survey Licence number 100046668.

© Copyright 2017 Jacobs U.K. Limited. The concepts and information contained in this document are the property of Jacobs. Use or copying of this document in whole or in part without the written permission of Jacobs constitutes an infringement of copyright. Limitation: This drawing has been prepared on behalf of, and for the exclusive use of, Jacobs Client, and is subject to, and issued in accordance with, the provisions of the contract between Jacobs and the Client. Jacobs accepts no liability or responsibility whatsoever for, or in respect of, any use of, or reliance upon, this drawing by any third party.

File: I:\Glen\07\PV01\ECBC\BWA\_Jobs\B2140005 A9 Dualing Temp folder\B2140005 Killiecrankie to Pitgovan\CAD\Watercourse Modifications\WF108.dwg Date: Aug 02, 2017 - 5:40pm Plotted by: WOODJA



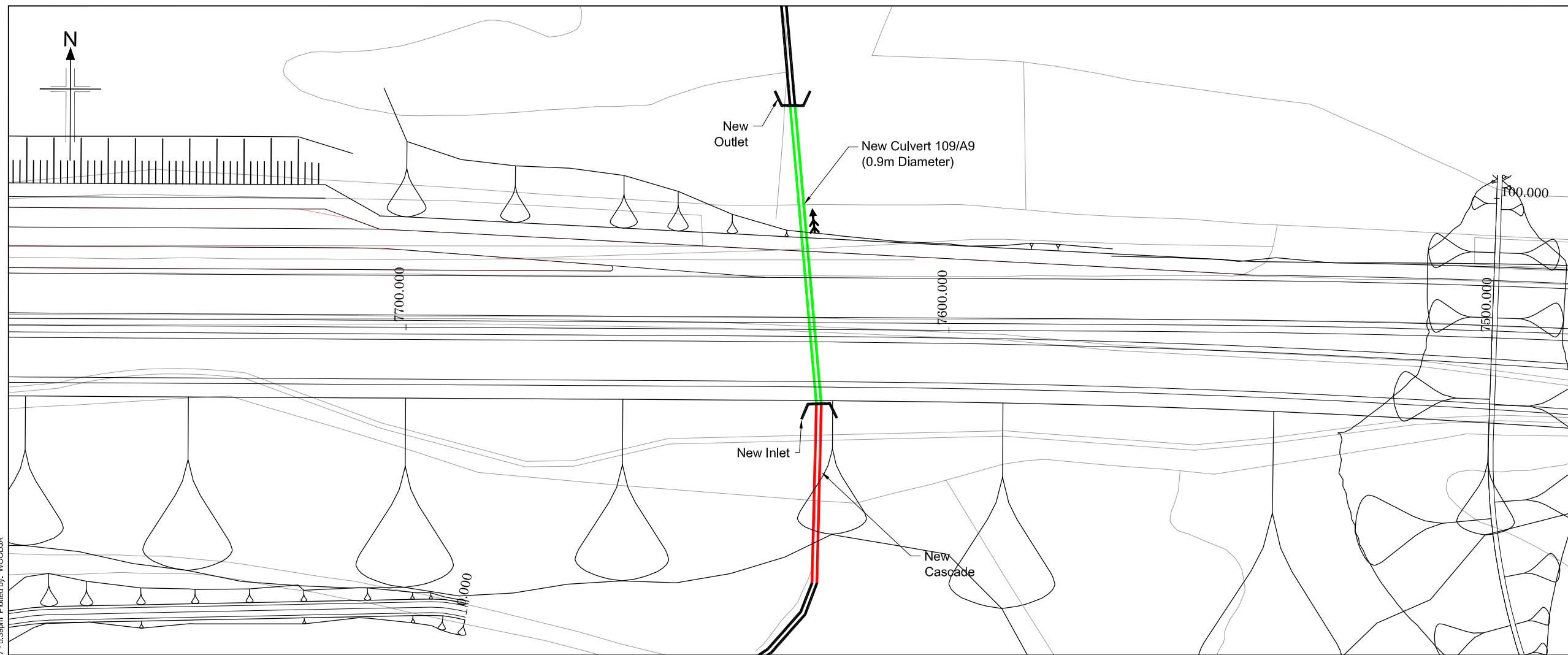

SCHEMATIC PLAN

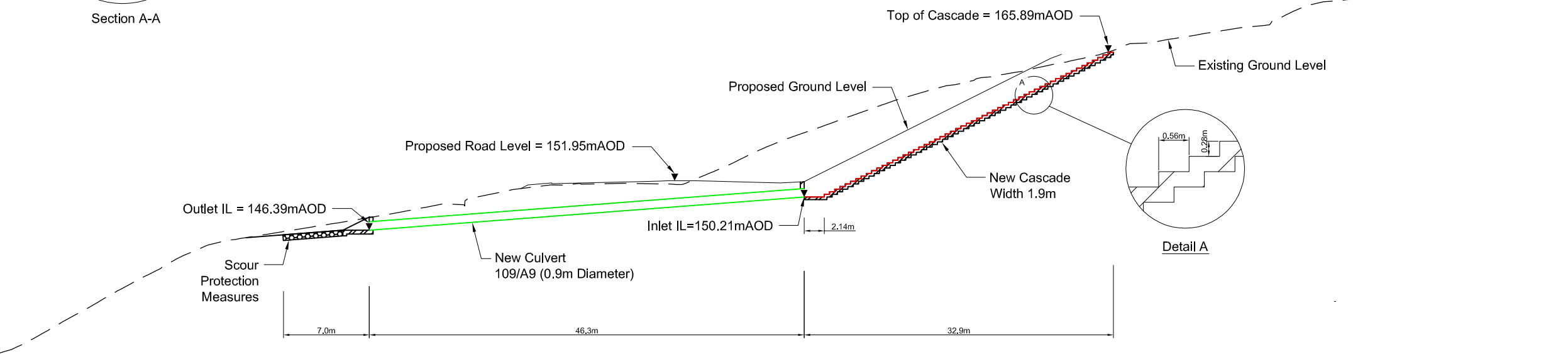
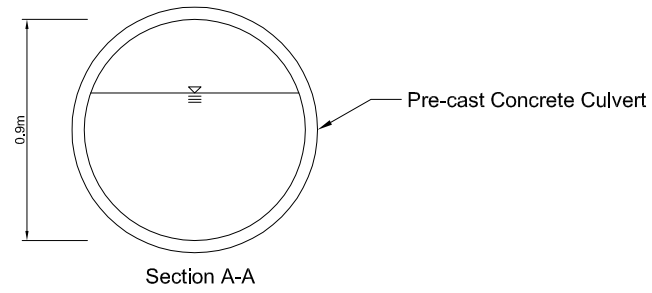

WATERCOURSE 109 LONGSECTION

- Legend:
- New culvert/extension
  - - - Retained culvert
  - Realigned/regraded channel
  - Cascade
  - Inlet/outlet headwall (new)
  - - - Inlet/outlet headwall (retained)
  - Pre-earthworks drain and outfall
  - Access chamber
  - Flow direction
  - IL Invert Level

- Notes:
1. All dimensions are in meters unless noted otherwise.
  2. All levels are in meters above ordnance datum.
  3. All details shown on this drawing are indicative only and subject to development at detailed design.
  4. This drawing shall be read in conjunction with the 'Watercourse Crossing report' only and not in isolation.
  5. All 'new' and 'extended' culverts have been designed in accordance with the relevant provisions of DMRB.
  6. Where required 'scour protection measures' shall be provided within the zone indicated on the drawing. The nature and the extent of the scour protection measure will be further developed at detailed design stage in accordance with the relevant provisions of DMRB, taking into account flow hydraulics, channel geometry and channel morphology.
  7. Where shown culverts shall be 'embedded' with natural river deposits to the depth shown.
  8. Where shown 'cascades' are required to safely convey the design flood event (0.5% AEP (200-year) plus allowance for climate change). The cascade geometry shown on the drawing is indicative only and will be subject to further development at detailed design stage. The nature of the cascade will take one of the following forms,
    - Bedrock channel cascade.
    - Natural cascade with natural gravels, cobbles and rock forming individual steps.
    - Concrete cascade with stone pitching.
 The nature of the cascade will be determined at the detailed design stage taking into account hydraulic requirements, topography and nature of the underlying strata and its susceptibility to fluvial erosion.
  9. Where shown mammal ledges will be provided within the culvert in accordance with the relevant provisions of DMRB.

Rev	Rev. Date	Purpose of revision	Drawn	Checked	Rev'd	Apprv'd
D	10/01/17	FOR INFORMATION	CON	JW	LMG	



Drawing title  
**KILLIECRANKIE TO GLEN GARRY PROPOSED MODIFICATIONS TO CULVERT ON WATERCOURSE WF109**

Drawing status  
**FOR INFORMATION**

Scale  
 NTS @ A1      DO NOT SCALE

Jacobs No.      B2140005

Drawing number  
**Figure A.11.8.18**

Rev  
**0**

Reproduced by permission of Ordnance Survey on behalf of HMSO. © Crown copyright and database right 2017. All rights reserved. Ordnance Survey Licence number 100046668.

File: I:\Glen\07\PV01\ECBC\BWA\_Job\B2140005 A9 Dualing Temp folder\B2140005 A9 Dualing CAD\Watercourse Modifications\WF109.dwg Date: Aug 02, 2017 - 5:39pm Plotted by: WOODJA

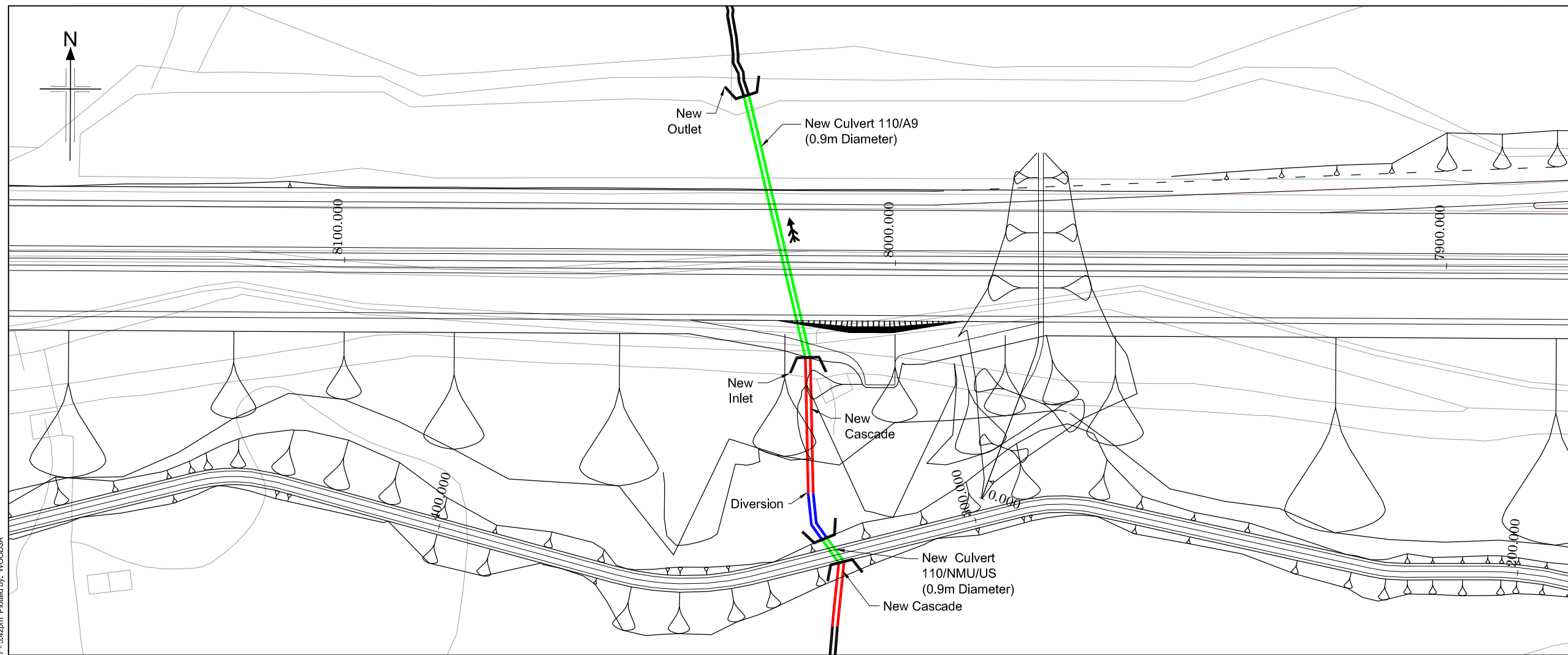

SCHEMATIC PLAN

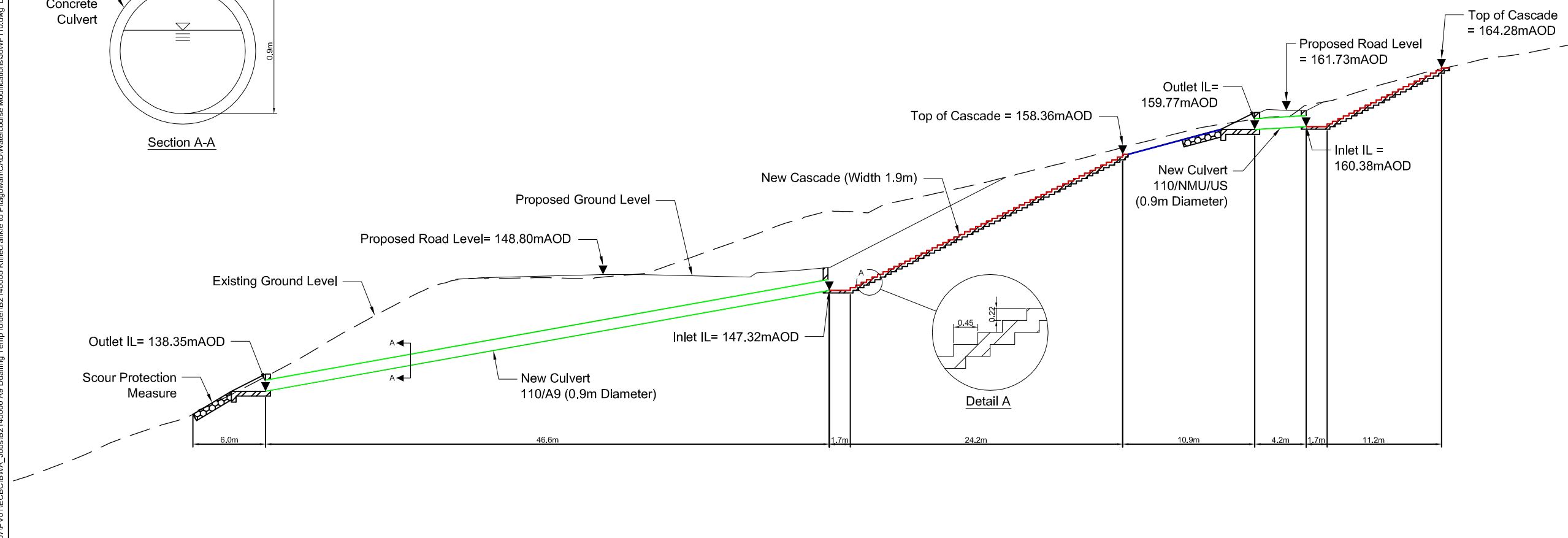
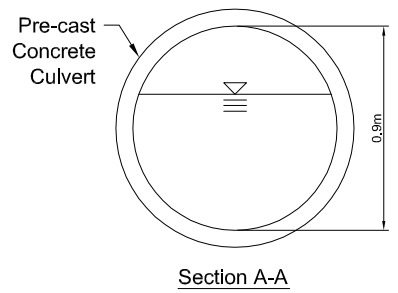

WATERCOURSE 110 LONGSECTION

- Legend:
- New culvert/extension
  - - - Retained culvert
  - Realigned/regraded channel
  - Cascade
  - Inlet/outlet headwall (new)
  - - - Inlet/outlet headwall (retained)
  - Pre-earthworks drain and outfall
  - Access chamber
  - Flow direction
  - IL Invert Level

- Notes:
1. All dimensions are in meters unless noted otherwise.
  2. All levels are in meters above ordnance datum.
  3. All details shown on this drawing are indicative only and subject to development at detailed design.
  4. This drawing shall be read in conjunction with the 'Watercourse Crossing report' only and not in isolation.
  5. All 'new' and 'extended' culverts have been designed in accordance with the relevant provisions of DMRB.
  6. Where required 'scour protection measures' shall be provided within the zone indicated on the drawing. The nature and the extent of the scour protection measure will be further developed at detailed design stage in accordance with the relevant provisions of DMRB, taking into account flow hydraulics, channel geometry and channel morphology.
  7. Where shown culverts shall be 'embedded' with natural river deposits to the depth shown.
  8. Where shown 'cascades' are required to safely convey the design flood event (0.5% AEP (200-year) plus allowance for climate change). The cascade geometry shown on the drawing is indicative only and will be subject to further development at detailed design stage. The nature of the cascade will take one of the following forms,
    - Bedrock channel cascade.
    - Natural cascade with natural gravels, cobbles and rock forming individual steps.
    - Concrete cascade with stone pitching.
 The nature of the cascade will be determined at the detailed design stage taking into account hydraulic requirements, topography and nature of the underlying strata and its susceptibility to fluvial erosion.
  9. Where shown mammal ledges will be provided within the culvert in accordance with the relevant provisions of DMRB.

Rev	Rev. Date	Purpose of revision	Drawn	Checkd	Rev'd	Apprv'd
0	10/01/17	FOR INFORMATION	COM	JW	LMG	



**KILLIECRANKIE TO GLEN GARRY PROPOSED MODIFICATIONS TO CULVERT ON WATERCOURSE WF110**

Drawing status: **FOR INFORMATION**

Scale: NTS @ A1 DO NOT SCALE

Jacobs No. B2140005

Drawing number: **Figure A.11.8.19**

Rev: **0**

Reproduced by permission of Ordnance Survey on behalf of HMSO. © Crown copyright and database right 2017. All rights reserved. Ordnance Survey Licence number 100046668.

© Copyright 2017 Jacobs U.K. Limited. The concepts and information contained in this document are the property of Jacobs. Use or copying of this document in whole or in part without the written permission of Jacobs constitutes an infringement of copyright. Limitation: This drawing has been prepared on behalf of, and for the exclusive use of, Jacobs Client, and is subject to, and limited in accordance with, the provisions of the contract between Jacobs and the Client. Jacobs accepts no liability or responsibility whatsoever for, or in respect of, any use of, or reliance upon, this drawing by any third party.

File: I:\Glarif\07\PV01\ECBC\BWA\_Job\B2140005 A9 Dualing Temp folder\B2140005 Killiecrankie to Pllagowan\CAD\Watercourse Modifications\WF110.dwg Date: Aug 02, 2017 - 5:42pm Plotted by: WOODJJA

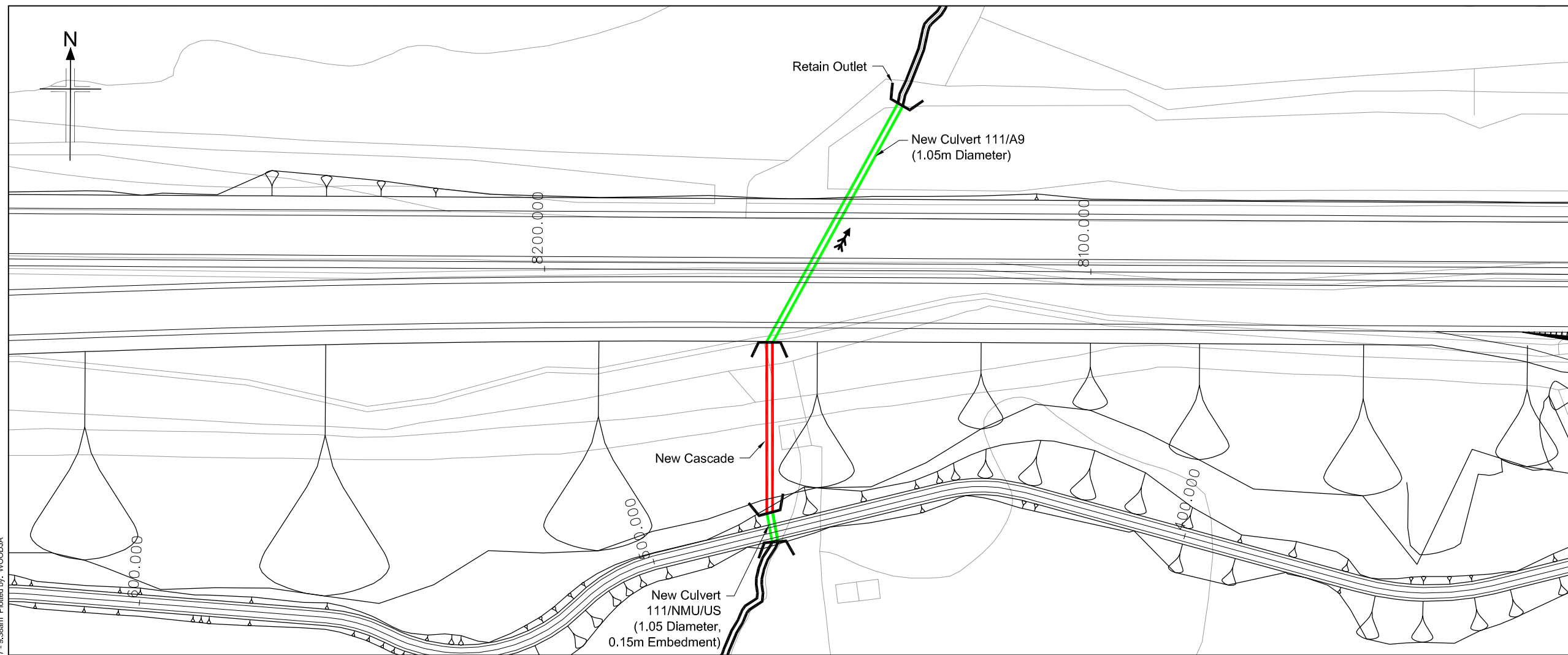

SCHEMATIC PLAN

- Legend:
- New culvert/extension
  - - - Retained culvert
  - Realigned/regraded channel
  - Cascade
  - Inlet/outlet headwall (new)
  - - - Inlet/outlet headwall (retained)
  - Pre-earthworks drain and outfall
  - Access chamber
  - Flow direction
  - IL Invert Level

- Notes:
1. All dimensions are in meters unless noted otherwise.
  2. All levels are in meters above ordnance datum.
  3. All details shown on this drawing are indicative only and subject to development at detailed design.
  4. This drawing shall be read in conjunction with the 'Watercourse Crossing report' only and not in isolation.
  5. All 'new' and 'extended' culverts have been designed in accordance with the relevant provisions of DMRB.
  6. Where required 'scour protection measures' shall be provided within the zone indicated on the drawing. The nature and the extent of the scour protection measure will be further developed at detailed design stage in accordance with the relevant provisions of DMRB, taking into account flow hydraulics, channel geometry and channel morphology.
  7. Where shown culverts shall be 'embedded' with natural river deposits to the depth shown.
  8. Where shown 'cascades' are required to safely convey the design flood event (0.5% AEP (200-year) plus allowance for climate change). The cascade geometry shown on the drawing is indicative only and will be subject to further development at detailed design stage. The nature of the cascade will take one of the following forms,
    - Bedrock channel cascade.
    - Natural cascade with natural gravels, cobbles and rock forming individual steps.
    - Concrete cascade with stone pitching.
 The nature of the cascade will be determined at the detailed design stage taking into account hydraulic requirements, topography and nature of the underlying strata and its susceptibility to fluvial erosion.
  9. Where shown mammal ledges will be provided within the culvert in accordance with the relevant provisions of DMRB.

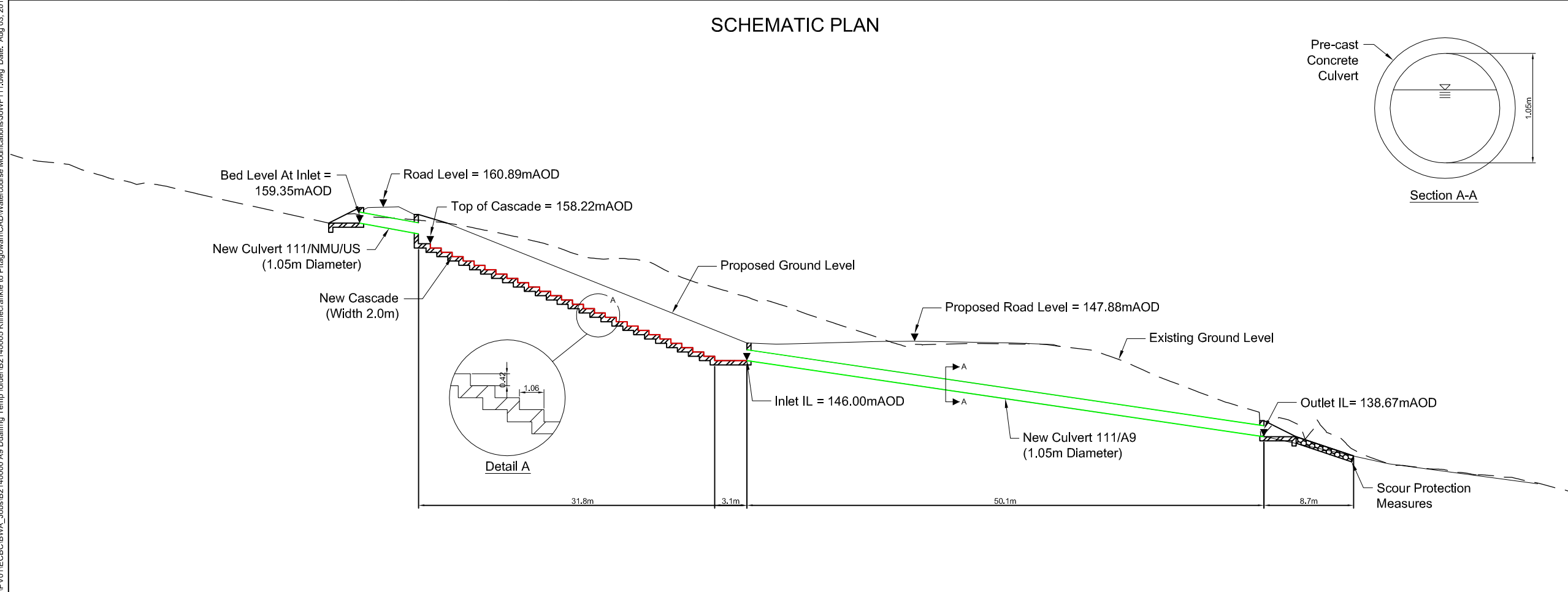

WATERCOURSE 111 LONGSECTION

Rev	Rev. Date	Purpose of revision	Drawn	Checkd	Rev'd	Apprv'd
0	10/01/17	FOR INFORMATION				



Drawing title  
**KILLIECRANKIE TO GLEN GARRY PROPOSED MODIFICATIONS TO CULVERT ON WATERCOURSE WF111**

Drawing status  
**FOR INFORMATION**

Scale  
 NTS @ A1      DO NOT SCALE

Jacobs No.  
 B2140005

Drawing number  
**Figure A.11.8.20**

Rev  
**0**

Reproduced by permission of Ordnance Survey on behalf of HMSO.  
 © Crown copyright and database right 2017. All rights reserved.  
 Ordnance Survey Licence number 100046668.

© Copyright 2017 Jacobs U.K. Limited. The concepts and information contained in this document are the property of Jacobs. Use or copying of this document in whole or in part without the written permission of Jacobs constitutes an infringement of copyright. Limitation: This drawing has been prepared on behalf of, and for the exclusive use of, Jacobs Client, and is subject to, and issued in accordance with, the provisions of the contract between Jacobs and the Client. Jacobs accepts no liability or responsibility whatsoever for, or in respect of, any use of, or reliance upon, this drawing by any third party.

File: I:\Glarif\07\PV01\ECBC\BWA\_Joos\B2140005 A9 Dualing Temp folder\B2140005 Killiecrankie to Pitagowan\CAD\Watercourse Modifications\WF11.dwg Date: Aug 03, 2017 - 9:38am Plotted by: WOODJJA

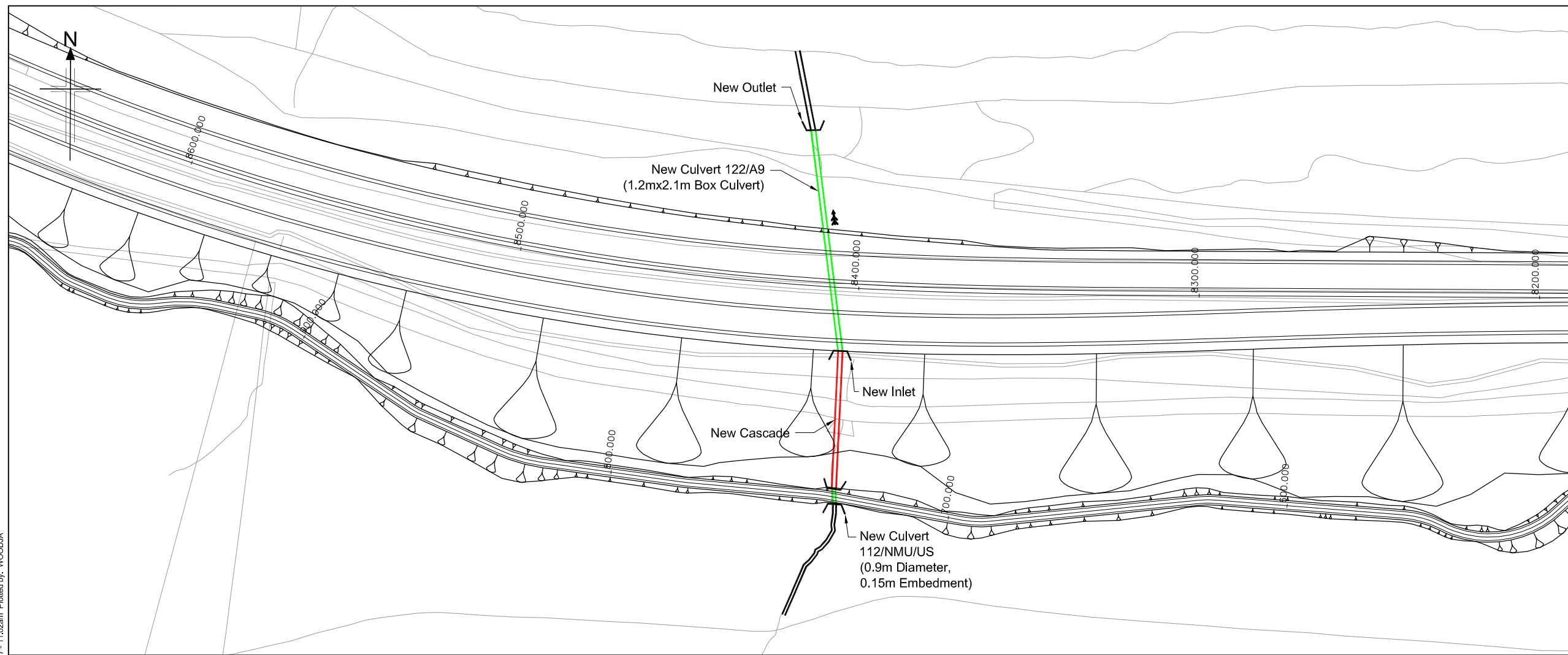

SCHEMATIC PLAN

- Legend:
- New culvert/extension
  - - - Retained culvert
  - Realigned/regraded channel
  - Cascade
  - Inlet/outlet headwall (new)
  - - - Inlet/outlet headwall (retained)
  - Pre-earthworks drain and outfall
  - Access chamber
  - Flow direction
  - IL Invert Level

- Notes:
1. All dimensions are in meters unless noted otherwise.
  2. All levels are in meters above ordnance datum.
  3. All details shown on this drawing are indicative only and subject to development at detailed design.
  4. This drawing shall be read in conjunction with the 'Watercourse Crossing report' only and not in isolation.
  5. All 'new' and 'extended' culverts have been designed in accordance with the relevant provisions of DMRB.
  6. Where required 'scour protection measures' shall be provided within the zone indicated on the drawing. The nature and the extent of the scour protection measure will be further developed at detailed design stage in accordance with the relevant provisions of DMRB, taking into account flow hydraulics, channel geometry and channel morphology.
  7. Where shown culverts shall be 'embedded' with natural river deposits to the depth shown.
  8. Where shown 'cascades' are required to safely convey the design flood event (0.5% AEP (200-year) plus allowance for climate change). The cascade geometry shown on the drawing is indicative only and will be subject to further development at detailed design stage. The nature of the cascade will take one of the following forms,
    - Bedrock channel cascade.
    - Natural cascade with natural gravels, cobbles and rock forming individual steps.
    - Concrete cascade with stone pitching.
 The nature of the cascade will be determined at the detailed design stage taking into account hydraulic requirements, topography and nature of the underlying strata and its susceptibility to fluvial erosion.
  9. Where shown mammal ledges will be provided within the culvert in accordance with the relevant provisions of DMRB.

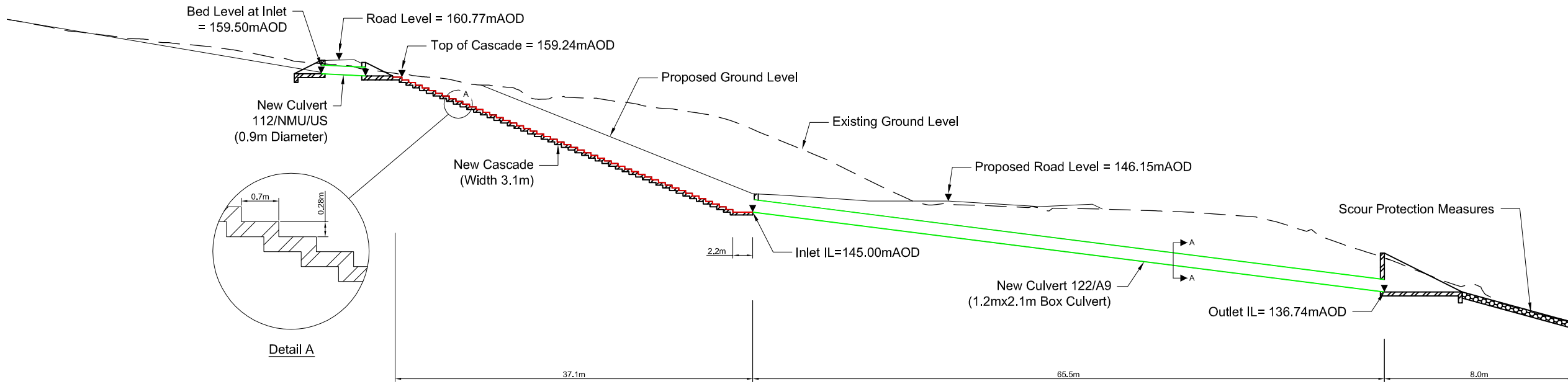
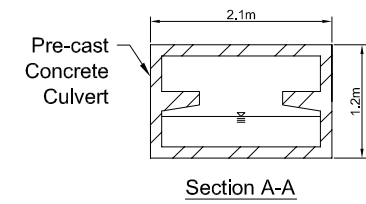

WATERCOURSE 112 LONGSECTION

D	10/01/17	FOR INFORMATION	CON	JW	LMG	
Rev	Rev. Date	Purpose of revision	Drawn	Checked	Rev'd	Apprv'd

**JACOBS**  
 95 Bothwell St, Glasgow, G2 7HX  
 Tel: +44(0)141 243 9000 Fax: +44(0)141 226 3109  
 www.jacobs.com



**KILLIECRANKIE TO GLEN GARRY PROPOSED MODIFICATIONS TO CULVERT ON WATERCOURSE WF112**

Drawing status: **FOR INFORMATION**

Scale: NTS @ A1 DO NOT SCALE

Jacobs No. B2140005

Drawing number: **Figure A.11.8.21**

Rev: **0**

Reproduced by permission of Ordnance Survey on behalf of HMSO.  
 © Crown copyright and database right 2017. All rights reserved.  
 Ordnance Survey Licence number 100046668.

© Copyright 2017 Jacobs U.K. Limited. The concepts and information contained in this document are the property of Jacobs. Use or copying of this document in whole or in part without the written permission of Jacobs constitutes an infringement of copyright. Limitation: This drawing has been prepared on behalf of, and for the exclusive use of, Jacobs Client, and is subject to, and limited in accordance with, the provisions of the contract between Jacobs and the Client. Jacobs accepts no liability or responsibility whatsoever for, or in respect of, any use of, or reliance upon, this drawing by any third party.

File: I:\Glarif\07\PV01\1ECBC\BWA\_Joos\B2140005\_Killiecrankie to Pitagowan\CAD\Watercourse Modifications\WF112.dwg Date: Aug 03, 2017 - 11:02am Plotted by: WOODJA

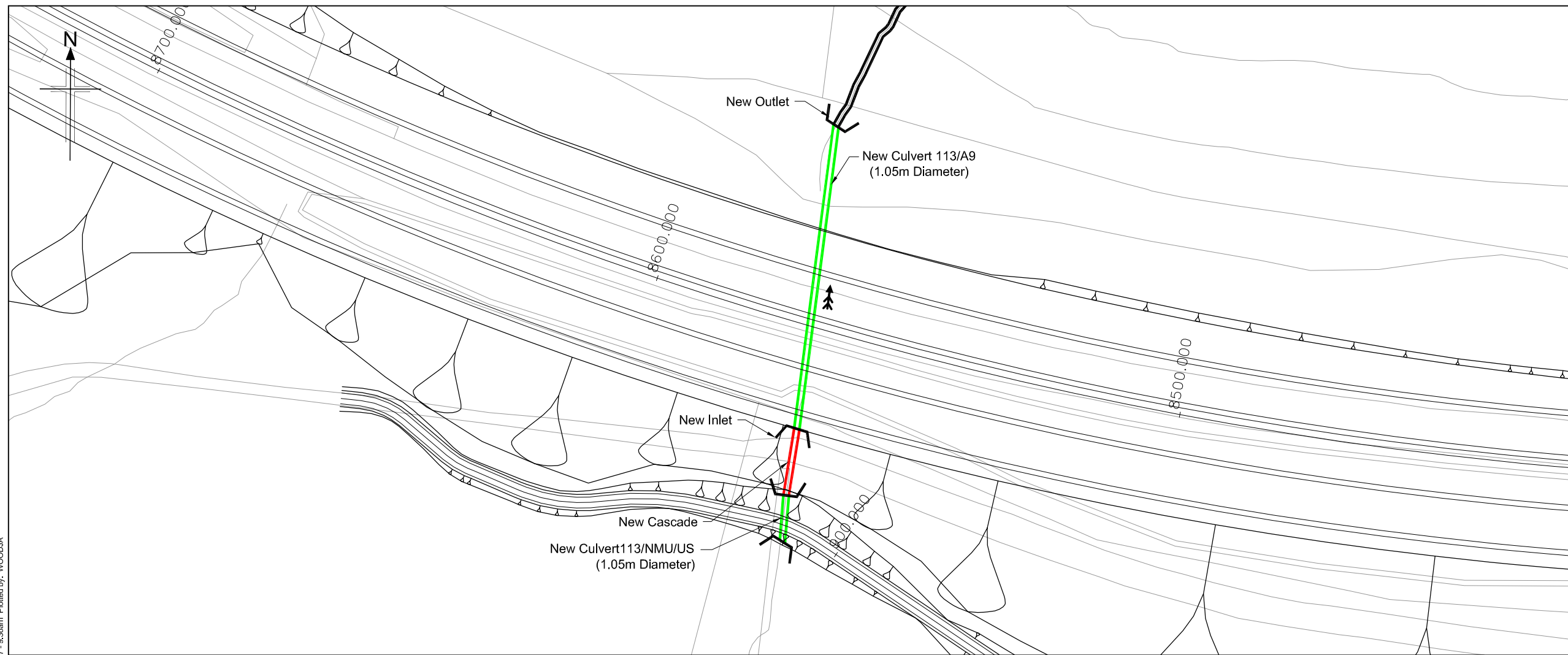

SCHEMATIC PLAN

- Legend:
- New culvert/extension
  - - - Retained culvert
  - Realigned/regraded channel
  - Cascade
  - Inlet/outlet headwall (new)
  - - - Inlet/outlet headwall (retained)
  - Pre-earthworks drain and outfall
  - Access chamber
  - Flow direction
  - IL Invert Level

- Notes:
1. All dimensions are in meters unless noted otherwise.
  2. All levels are in meters above ordnance datum.
  3. All details shown on this drawing are indicative only and subject to development at detailed design.
  4. This drawing shall be read in conjunction with the 'Watercourse Crossing report' only and not in isolation.
  5. All 'new' and 'extended' culverts have been designed in accordance with the relevant provisions of DMRB.
  6. Where required 'scour protection measures' shall be provided within the zone indicated on the drawing. The nature and the extent of the scour protection measure will be further developed at detailed design stage in accordance with the relevant provisions of DMRB, taking into account flow hydraulics, channel geometry and channel morphology.
  7. Where shown culverts shall be 'embedded' with natural river deposits to the depth shown.
  8. Where shown 'cascades' are required to safely convey the design flood event (0.5% AEP (200-year) plus allowance for climate change). The cascade geometry shown on the drawing is indicative only and will be subject to further development at detailed design stage. The nature of the cascade will take one of the following forms,
    - Bedrock channel cascade.
    - Natural cascade with natural gravels, cobbles and rock forming individual steps.
    - Concrete cascade with stone pitching.
 The nature of the cascade will be determined at the detailed design stage taking into account hydraulic requirements, topography and nature of the underlying strata and its susceptibility to fluvial erosion.
  9. Where shown mammal ledges will be provided within the culvert in accordance with the relevant provisions of DMRB.

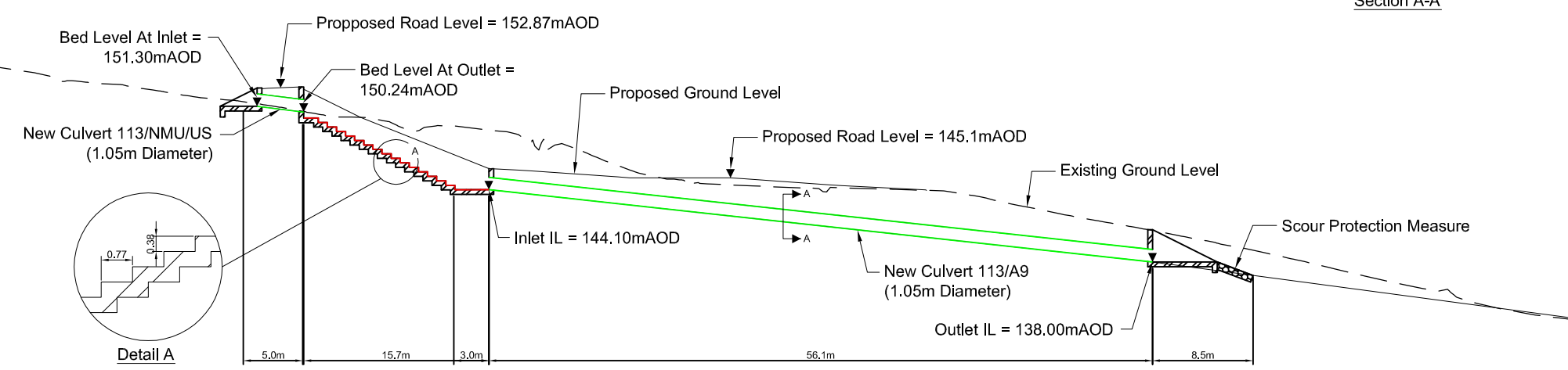
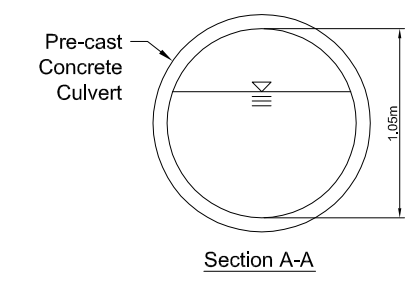

WATERCOURSE 113 LONGSECTION

D	10/01/17	FOR INFORMATION	CON	JW	LMG	
Rev	Rev. Date	Purpose of revision	Drawn	Checked	Rev'd	Apprv'd

**JACOBS**  
 95 Bothwell St, Glasgow, G2 7HX  
 Tel: +44(0)141 243 9000 Fax: +44(0)141 226 3109  
 www.jacobs.com



Drawing title  
**KILLIECRANKIE TO GLEN GARRY  
 PROPOSED MODIFICATIONS  
 TO CULVERT ON  
 WATERCOURSE WF113**

Drawing status  
**FOR INFORMATION**

Scale  
 NTS @ A1 DO NOT SCALE

Jacobs No. B2140005

Drawing number  
**Figure A.11.8.22**

Rev  
**0**

File: I:\Glarif\07\PV01\1ECBC\BWA\_Job\B2140005\_A9\_Dualling\_Temp\_folder\B2140005\_A9\_Dualling\_CAD\Watercourse Modifications\WF113.dwg Date: Aug 03, 2017 - 9:38am Plotted by: WOODJA

Reproduced by permission of Ordnance Survey on behalf of HMSO.  
 © Crown copyright and database right 2017. All rights reserved.  
 Ordnance Survey Licence number 100046668.

© Copyright 2017 Jacobs U.K. Limited. The concepts and information contained in this document are the property of Jacobs. Use or copying of this document in whole or in part without the written permission of Jacobs constitutes an infringement of copyright. Limitation: This drawing has been prepared on behalf of, and for the exclusive use of, Jacobs Client, and is subject to, and limited in accordance with, the provisions of the contract between Jacobs and the Client. Jacobs accepts no liability or responsibility whatsoever for, or in respect of, any use of, or reliance upon, this drawing by any third party.

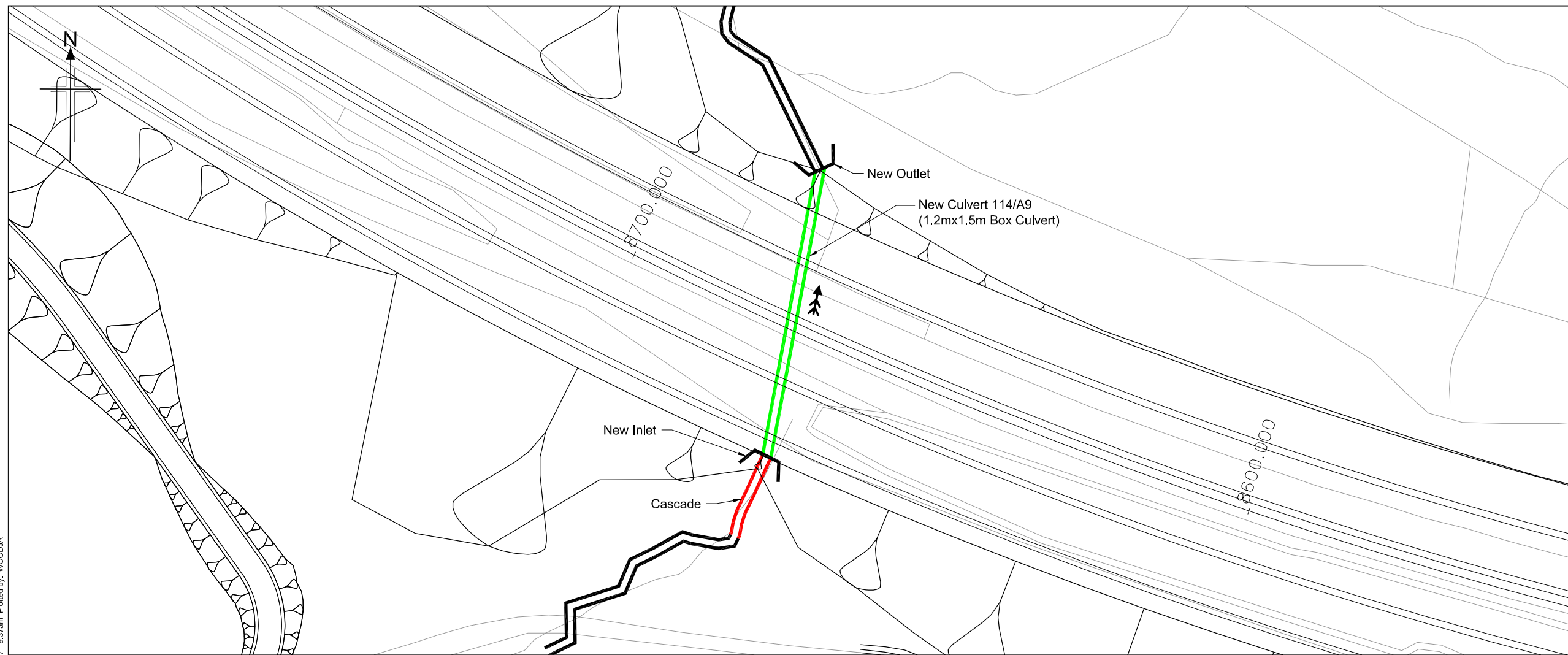

SCHMATIC PLAN

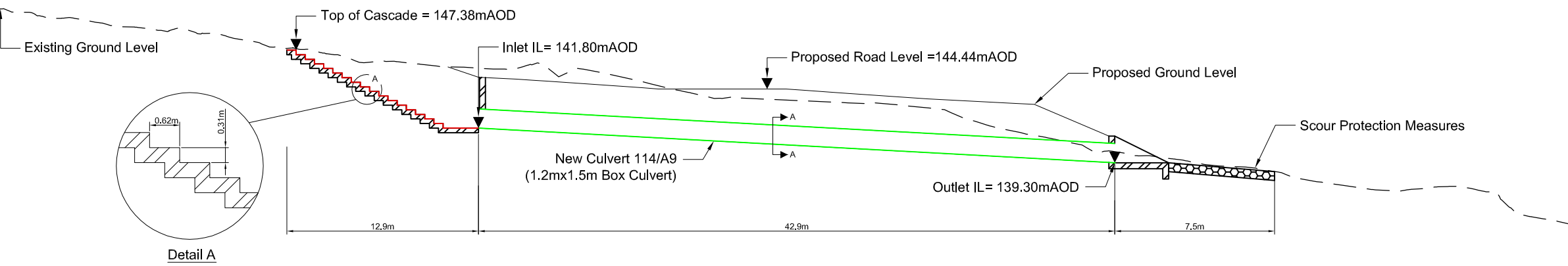
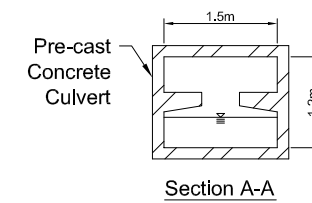

WATERCOURSE 114 LONGSECTION

- Legend:
- New culvert/extension
  - - - Retained culvert
  - Realigned/regraded channel
  - Cascade
  - Inlet/outlet headwall (new)
  - - - Inlet/outlet headwall (retained)
  - Pre-earthworks drain and outfall
  - Access chamber
  - Flow direction
  - IL Invert Level

- Notes:
1. All dimensions are in meters unless noted otherwise.
  2. All levels are in meters above ordnance datum.
  3. All details shown on this drawing are indicative only and subject to development at detailed design.
  4. This drawing shall be read in conjunction with the 'Watercourse Crossing report' only and not in isolation.
  5. All 'new' and 'extended' culverts have been designed in accordance with the relevant provisions of DMRB.
  6. Where required 'scour protection measures' shall be provided within the zone indicated on the drawing. The nature and the extent of the scour protection measure will be further developed at detailed design stage in accordance with the relevant provisions of DMRB, taking into account flow hydraulics, channel geometry and channel morphology.
  7. Where shown culverts shall be 'embedded' with natural river deposits to the depth shown.
  8. Where shown 'cascades' are required to safely convey the design flood event (0.5% AEP (200-year) plus allowance for climate change). The cascade geometry shown on the drawing is indicative only and will be subject to further development at detailed design stage. The nature of the cascade will take one of the following forms,
    - Bedrock channel cascade.
    - Natural cascade with natural gravels, cobbles and rock forming individual steps.
    - Concrete cascade with stone pitching.
 The nature of the cascade will be determined at the detailed design stage taking into account hydraulic requirements, topography and nature of the underlying strata and its susceptibility to fluvial erosion.
  9. Where shown mammal ledges will be provided within the culvert in accordance with the relevant provisions of DMRB.

Rev	Rev. Date	Purpose of revision	Drawn	Checked	Rev'd	Apprv'd
0	10/01/17	FOR INFORMATION				

**JACOBS**  
 95 Bothwell St, Glasgow, G2 7HX  
 Tel: +44(0)141 243 9000 Fax: +44(0)141 226 3109  
 www.jacobs.com



**KILLIECRANKIE TO GLEN GARRY  
 PROPOSED MODIFICATIONS  
 TO CULVERT ON  
 WATERCOURSE WF114**

Drawing status: **FOR INFORMATION**

Scale: NTS @ A1 | DO NOT SCALE

Jacobs No. B2140005

Drawing number: **Figure A.11.8.23** | Rev: **0**

File: I:\Glarif\07\PV01\ECBC\BWA\_Job\B2140000 A9 Dualling Temp folder\B2140005 Killiecrankie to Pitagowan\CAD\Watercourse Modifications\WF114.dwg Date: Aug 03, 2017 - 9:37am Plotted by: WOODJA

Reproduced by permission of Ordnance Survey on behalf of HMSO.  
 © Crown copyright and database right 2017. All rights reserved.  
 Ordnance Survey Licence number 100046668.

© Copyright 2017 Jacobs U.K. Limited. The concepts and information contained in this document are the property of Jacobs. Use or copying of this document in whole or in part without the written permission of Jacobs constitutes an infringement of copyright. Limitation: This drawing has been prepared on behalf of, and for the exclusive use of, Jacobs Client, and is subject to, and limited in accordance with, the provisions of the contract between Jacobs and the Client. Jacobs accepts no liability or responsibility whatsoever for, or in respect of, any use of, or reliance upon, this drawing by any third party.

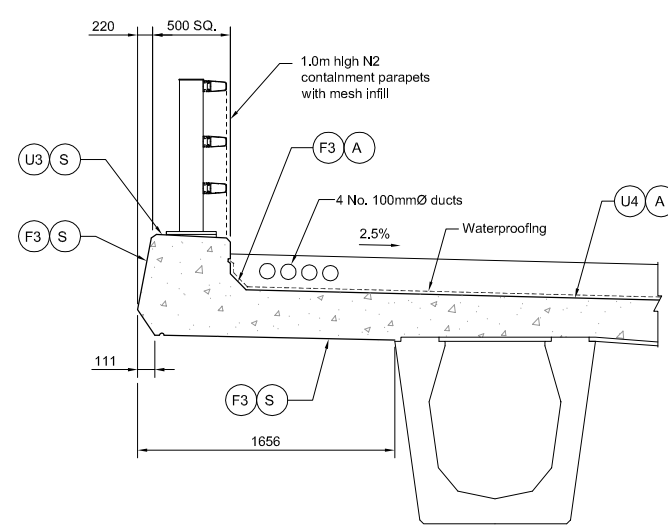
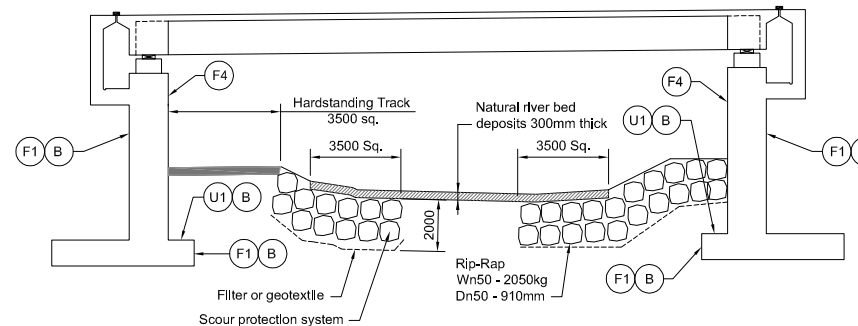
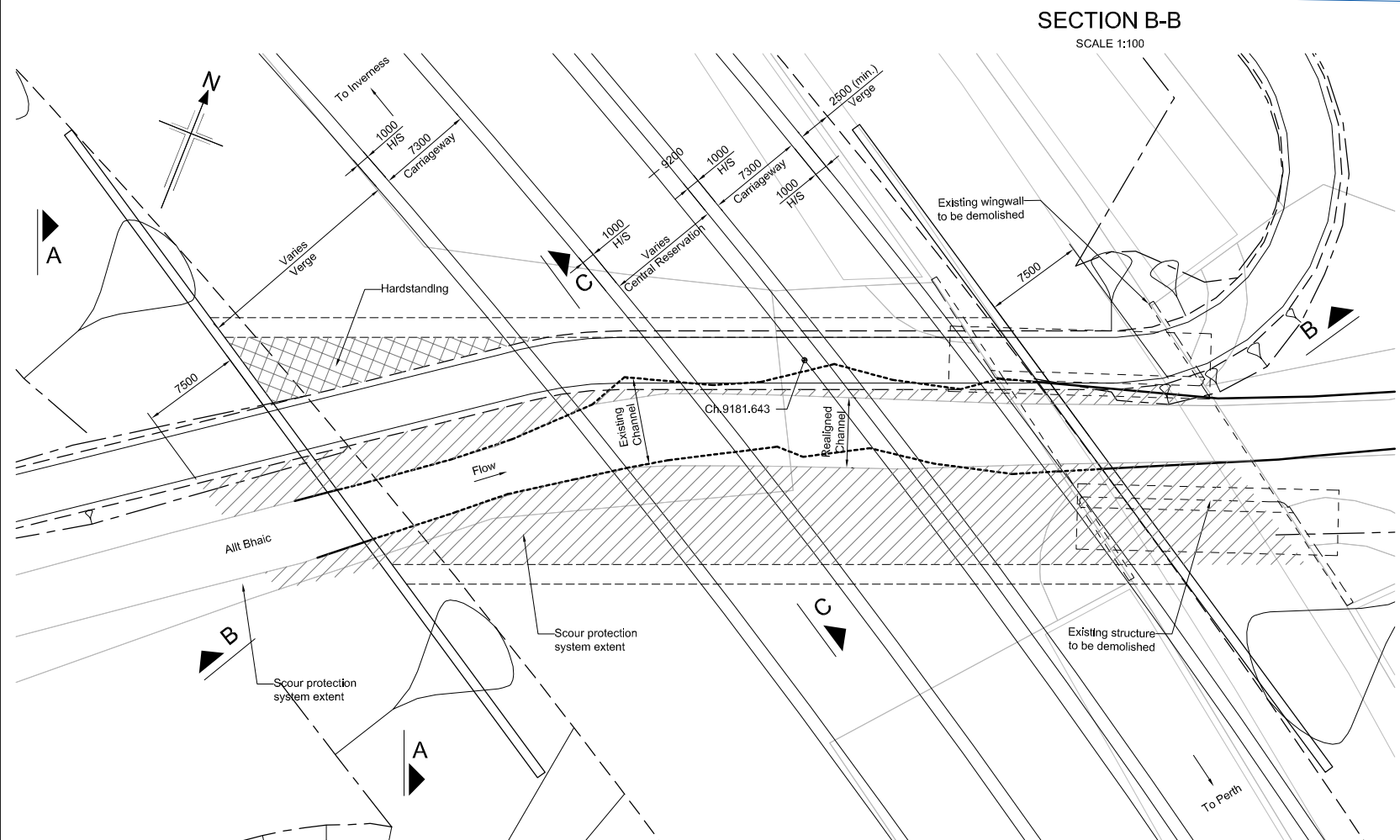
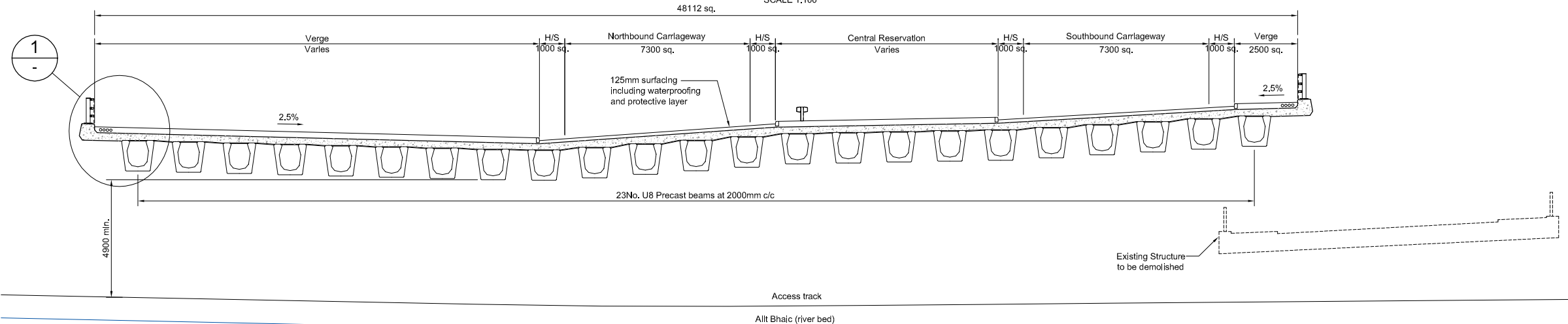
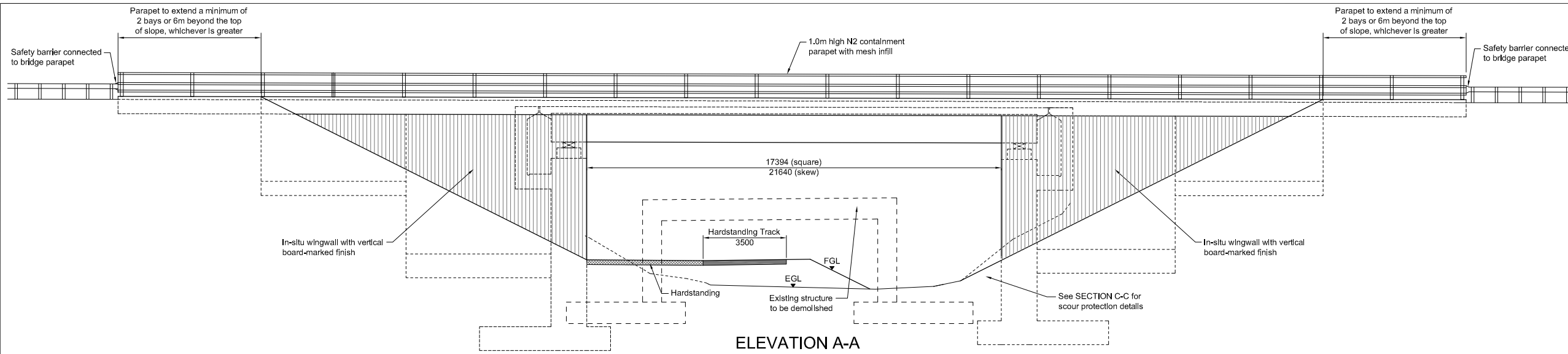

- Notes.**
- All dimensions are in millimetres unless noted otherwise.
  - All levels are in metres Above Ordnance Datum.
  - All chainages are in metres.
  - All exposed arrises to have 25x25 chamfers unless noted otherwise.
  - Concrete finishes denoted thus:  
(F) - Formed  
(U) - Unformed
  - Concrete protection to be as follows:  
(S) - Surface Impregnation in accordance with BD43 of the DMRB  
(A) - Spray applied waterproofing in accordance with CI 2003 of the Specification.  
(B) - Waterproofing of all buried concrete surfaces in accordance with CI 2004 of the Specification.
  - All details shown on this drawing are indicative only and subject to development.
  - Where required a scour protection system shall be provided within the area indicated on the drawing. The nature and extent of the scour protection system will be further developed at detail design stage in accordance with DMRB, but may consist of a rock armour (rip-rap) system as shown.
  - The hardstanding track beneath the bridge shall be resistant to fluvial scour and extend between the top of the scour protecting system and the bridge abutment face and also extend 7.5m upstream and downstream of the bridge.

SAFETY, HEALTH AND ENVIRONMENTAL INFORMATION	
In addition to the hazards/risks normally associated with the types of work detailed on this drawing, note the following:	
<b>CONSTRUCTION</b>	
- Service survey required pre-construction	
- Nature and position of the existing structure foundations to be verified pre-construction by undertaking investigations	
- Position of existing structure may not be as shown	
<b>MAINTENANCE / CLEANING</b>	
- None	
<b>DECOMMISSIONING / DEMOLITION</b>	
- None	
It is assumed that all works will be carried out by a competent contractor working, where appropriate, to an approved method statement	

Rev	Rev. Date	Purpose of revision	Drawn	Checked	Rev'd	Appr'd
P2	15/05/17	DMRB Stage 3 Report - Draft	MG	JA	MAM	ELM
P1	11/10/16	Design Fk 3	MR	MAM	MAM	ELM

**JACOBS**  
95 Bothwell St, Glasgow, G2 7HX  
Tel: +44(0)141 243 8000 Fax: +44(0)141 226 3109  
www.jacobs.com



**KILLIECRANKIE TO GLEN GARRY  
ALLT BHAIC UNDERBRIDGE  
GENERAL ARRANGEMENT**

Drawing status	
Scale	AS SHOWN @ A1 DO NOT SCALE
Jacobs No.	B2140005
Drawing number	Figure A.11.8.24
Rev	P2

This drawing is not to be used in whole or part other than for the intended purpose and project as defined on this drawing. Refer to the contract for full terms and conditions.

Reproduced by permission of Ordnance Survey on behalf of HMSO.  
© Crown copyright and database right 2017. All rights reserved.  
Ordnance Survey Licence number 100046668.